



# APPLICATION GUIDE

## 4WD SUSPENSION RECOVERY GEAR

JUNE 2018



### AUSTRALIA

163 Granite Street Geebung 4034, Queensland Australia

Phone: +61 7 3265 4142

[contact@outbackarmour.com.au](mailto:contact@outbackarmour.com.au)

[facebook.com/outbackarmour](https://www.facebook.com/outbackarmour)

[outbackarmour.com.au](http://outbackarmour.com.au)

NEVER GO ALONE

# RECOVERY GEAR

Outback Armour recovery products are designed & engineered in-house to have the strength, durability & reliability required for the most demanding applications. All core recovery products are independently tested and certified for ratings to the highest Australian Standards for the safety of you, your vehicle and bystanders.

Our range of feature-rich recovery products has been developed in conjunction with off-road industry experts and extensive user feedback.

## TECHNICAL SPECIFICATIONS

### RECOVERY HARDWARE

- \* 4.75T & 5.75T rated bow shackles
- \* 10T rated snatch block
- \* 10T rated recovery hitch
- \* 3D CAD engineered
- \* precision manufactured
- \* certified to Australian Standards

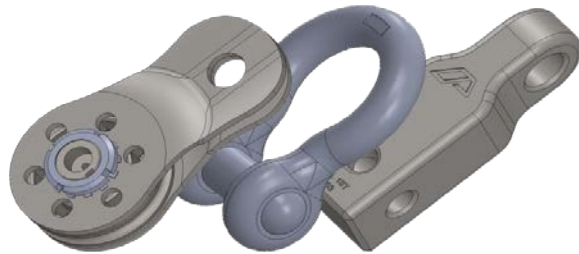

### RECOVERY BAGS

- \* water/tear resistant
- \* high strength reinforced PVC
- \* original YKK heavy duty zippers



### RECOVERY STRAPS

- \* 6T, 8T, 11T & 15T rated snatch straps
- \* 4T rated recoil tow strap
- \* 10T rated equaliser strap
- \* 10T rated tree trunk protector strap
- \* 10T rated winch extension strap



# SUSPENSION

OFF-ROAD

ARMoured

MILITARY

Outback Armour suspension products are designed & engineered in-house to have the strength, durability, performance & reliability required for the most demanding applications.

Benefit from more than 35 years experience with our full range of struts, shock absorbers, steering dampers, coil springs, leaf springs, u-bolts, shackles, pins and associated fitment hardware.

## TECHNICAL SPECIFICATIONS

### SHOCK ABSORBERS & STRUTS

- \* performance & internal adjustable bypass
- \* seamless high pressure twin tube
- \* nitrogen gas over semi-synthetic oil
- \* high temperature multi lip viton seal
- \* hardened chrome piston rod
- \* performance high-flow piston
- \* heavy duty multi-disc valving
- \* extra strong forged single piece strut leg
- \* high density engineered rubber bushes
- \* high strength adjustable height spring seat



### COIL SPRINGS

- \* high stress vanadium alloy steel
- \* precision hot wound
- \* scragg tested & load rated

### LEAF SPRINGS

- \* high stress alloy spring steel
- \* integrated slipper pads
- \* HDPE clip silencers
- \* scragg tested & load rated



**\*3 YEAR  
UNLIMITED KM  
WARRANTY**

\* 1 year on strut bushes



## CONTACT US



### AUSTRALIA (HEAD OFFICE)

<b>Street Address</b>	163 Granite Street Geebung 4034 Queensland, Australia
<b>Postal Address</b>	PO Box 500 Hamilton Central 4007 Queensland, Australia
<b>Phone</b>	+61 7 3265 4142
<b>Email</b>	sales@outbackarmour.com.au accounts@outbackarmour.com.au contact@outbackarmour.com.au
<b>Social Media</b>	facebook.com/outbackarmour instagram.com/outbackarmour
<b>Website</b>	www.outbackarmour.com.au

### UNITED ARAB EMIRATES

<b>Street Address</b>	Warehouse 7, Shed 5 Technology Park, RAK Free Trade Zone Ras Al Khaimah, United Arab Emirates
<b>Postal Address</b>	PO Box 5013586 Ras Al Khaimah, United Arab Emirates
<b>Phone</b>	Office: +971 7 2433950 Mobile: +971 544440635
<b>Email</b>	<a href="mailto:uae@outbackarmour.com.au">uae@outbackarmour.com.au</a>



The parts, vehicles & specifications listed in this suspension application guide have been compiled as carefully as possible. Whilst all care and attention has been given to the accuracy of information provided, we do not assume any responsibility for possible errors and/or omissions which may or may not be contained herein.

# INDEX

as at June 2018

MAKE	MODEL	YEAR	PAGE
Ford	Ranger PJ/PK	9/2006 - 8/2011	8-10
	Ranger PX/PX2	9/2011 +	12-15
	Everest	2015 +	16-18
Great Wall	V200 & V240	6/2009 +	20-23
Holden	Colorado RC	9/2008 - 7/2011	20-23
	Colorado RG	8/2011 +	24-27
	Colorado 7	2012 - 2017	28-30
	Trailblazer	2017 +	28-30
	Rodeo RA	3/2003 - 2008	20-23
Isuzu	D-Max	7/2008 - 9/2012	32-35
	D-Max	2012 +	36-39
	Mu-X	9/2013 +	40-42
Jeep	Grand Cherokee WK2	2011 +	44-46
	Wrangler TJ	1996 - 2006	48-49
	Wrangler JK SWB	2007 +	50-51
	Wrangler JK LWB	2007 +	52-53
Mazda	BT-50	10/2006 - 9/2011	54-56
	BT-50	10/2011 +	58-61
Mercedes-Benz	X-Class	2018+	62-65
Mitsubishi	Triton ML/MN/L200	5/2006 +	66-69
	Triton MQ	2015 +	70-73
	Challenger PB/PC	2008 - 2016	74-76
	Pajero NM-NX (Petrol)	1999 - 2016	78-80
	Pajero NM-NX (Diesel)	1999 - 2016	82-84
	Pajero Sport	2016 +	86-88
Nissan	Navara D22	1997 +	90-93
	Navara D40 (4CYL & V6 Petrol)	2005 - 2015	94-97
	Navara D40 (V6 Diesel)	2010 - 2015	98-101
	Navara NP300 (Coil Rear)	2015 +	102-105
	Navara NP300 (Leaf Rear)	2015 +	106-109
	Pathfinder R51	2005 - 2012	110-113
	Patrol GU Y61 Wagon	1997 +	114-116
Photon	Tunland	2012+	122-126
Toyota	FJ Cruiser 15 Series	9/2010 +	118-120
	Hilux IFS (pre 2005)	pre 2005	198
	Hilux 150 Series	2005 - 2015	122-126
	Hilux Generation 8	2015 +	128-133
	Fortuner Generation 3	2015 +	134-136
	Landcruiser 75 Series	1984 - 1999	198
	Landcruiser 76 Series	2007 +	138-142
	Landcruiser 78 Series (6 Cyl pre 2007)	2000 - 2006	144-149
	Landcruiser 78 Series (V8 2007+)	2007 +	150-155
	Landcruiser 79 Series (6 Cyl pre 2007)	2000 - 2006	156-161
	Landcruiser 79 Series Single/Dual Cab (V8 '07-'16)	2007 - 2016	162-167
	Landcruiser 79 Series Single Cab (V8 2017+)	2017+	168-173
	Landcruiser 80/105 Series Live Axle	9/1991 - 2006	174-176
	Landcruiser 100 Series IFS	4/1998 - 10/2007	178-180
	Landcruiser 200 Series	11/2007 +	182-184
	Landcruiser Prado 120 Series	2002 - 2009	186-189
Landcruiser Prado 150 Series	8/2009 +	190-193	
Volkswagen	Amarok (4CYL & V6)	4/2010 +	194-197
Suspension Spare Parts & Additional Lines			198
Strut Alignment Guides & Vehicle Fitment Record			199-201
Warranty Policy, Terms & Conditions of Sale			202-203
Recovery Gear			204-209

TERMINOLOGY	UNIT	DETAILS
<b>Centre Wheel to Guard - CWG</b>	mm	<p>CWG (Centre Wheel to Guard) is measured vertically from the centre of the wheel to the under-side of the guard on each corner of the vehicle.</p> <p>Taking the measurement from the centre of the wheel provides an accurate point of comparison across multiple vehicles, excluding any impact of wheel or tyre selection.</p> <p>The CWG measurements should be recorded prior to and following the installation of suspension.</p> <p>Note: BSD (Bump Stop to Diff-Housing) is the clear space measured between the bump stop and diff housing on TLC79.</p>
<b>Max/Min Acceptable CWG</b>	mm	<p>Max/Min Acceptable CWG are shown as a recommended guideline only, indicating the recommended safe and/or legally acceptable vertical height limits of the vehicle.</p>
<b>Left Axis - CWG</b>	mm	<p>Shows the CWG height that can be reasonably expected for each leaf spring variant, relative to applied load.</p>
<b>Bottom Axis - Load</b>	KG	<p>Shows the load applied in addition to the standard original equipment style-side tray (or steel tray in the case of the TLC79).</p>

**GRAPH INTERPRETATION**

In the example graph on the facing page, the following information can be ascertained:

- 1 The min & max recommended acceptable vertical height for the vehicle are 500mm & 575mm respectively.
2. The original equipment leaf spring (OE, black trace) ride height starts at 535mm CWG unladen and drops below the minimum acceptable vertical height after 400kg of applied load.
3. The Outback Armour "Trail" spec leaf spring provides a ride height of 575mm CWG when unladen and does not drop below the minimum acceptable vertical height after 1000kg of applied load.
4. The Outback Armour "Expedition" spec leaf spring provides a ride height of 575mm CWG after an additional 150kg of applied load and does not drop below the minimum acceptable vertical height with more than 1000kg of applied load.

Note: When selecting the appropriate leaf pack for a specific application, the applied load required to meet the maximum vertical height should always be considered for vehicle safety and reliability.

EXAMPLE GRAPH

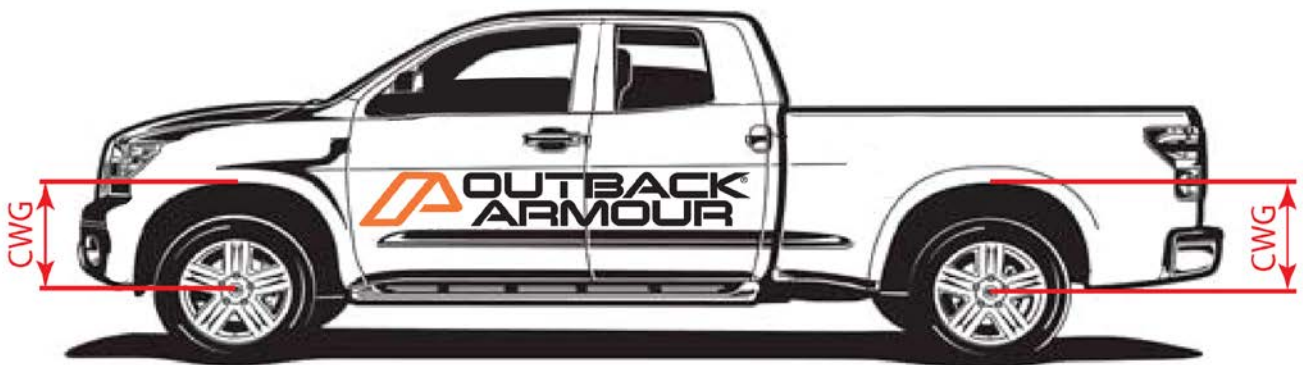
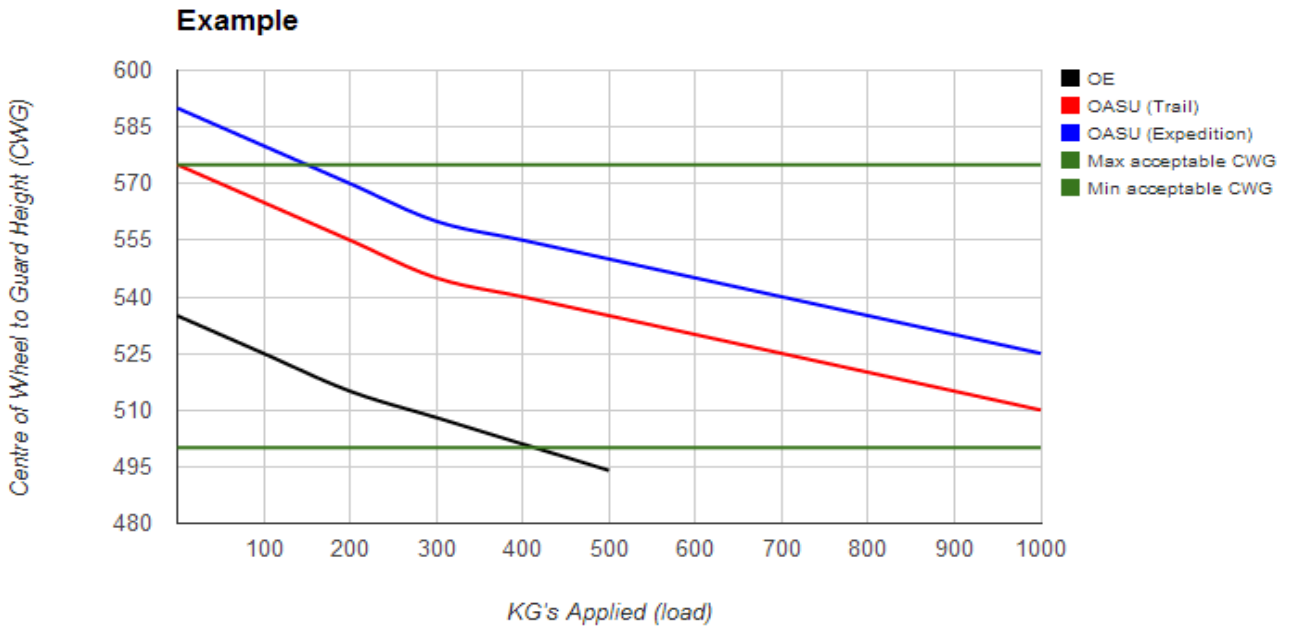

# FORD RANGER PJ/PK

9/2006 - 8/2011



PRODUCT	PART NO.	QTY	DETAILS
<b>Shock Absorbers</b> (front)	OASU0160008 \$175 ea.	2	<b>Performance</b> - 60mm twin tube. Complete set of rubber bushes, washers & dust boot included.
<b>Shock Absorbers</b> (rear)	OASU0160009 \$175 ea.	2	<b>Performance</b> - 60mm twin tube. Complete set of rubber bushes included. Steel shroud.
<b>Torsion Bars</b> (pair)	OASU1211150 \$295 pr.	1	Trail / Expedition <i>Increased rate, 1025mm length, 27mm diameter.</i>
<b>Leaf Springs</b>	OASU1149001 \$250 ea.	2	Trail - 35mm lift (approx unladen) <i>4 primary + 2 secondary</i>
	OASU1149002 \$275 ea.	2	Expedition - 35mm lift (@ approx 250kg load) <i>4 primary + 2 secondary</i>
<i>** Refer leaf spring graph following for approximate deflections under load.</i>			
<b>Leaf Spring Bush Kit</b>	OASU210020K \$135 kit	1	12 polyurethane bushes & 2 inner tubes
<b>U-bolts</b>	OASU2388003 \$15 ea.	4	Suits leaf springs: OASU1149001 <i>M14 x 88 ID (RND) x 185 L</i>
	OASU2388001 \$15 ea.	4	Suits leaf springs: OASU1149002 <i>M14 x 88 ID (RND) x 210 L</i>
<i>** All u-bolts hardened steel, rolled threads, deep nuts &amp; spring washers.</i>			
<b>Pins</b>	OASU2500042 \$20 ea.	2	Greasable, hardened steel
<b>Shackles</b>	OASU2400054 \$35 ea.	2	Greasable, hardened steel pins

## ACCESSORY ITEMS & CORRECTION COMPONENTS

<b>Bump Stops</b>	OASU4248004 \$85 kit	1	Rear - Rubber, extended progressive rate (2x 110mm).
-------------------	-------------------------	---	--

\* Ride heights approximate only, based on standard dual cab style-side ute with no additional load, unless otherwise stated.

\* Outback Armour recommend that a minimum of two thirds of the original suspension travel in each direction is retained for optimal performance and durability.

## RECOMMENDED RECOVERY GEAR

<b>Snatch Strap</b>	OASS6T9M	1	Dynamic Snatch Strap - 6T/9M (2.00T - 3.00T)
<b>Recovery Kits</b>	OAQUICKSKST	1	Quick Snatch Kit - Small Truck
	OACOMPSKST	1	Comp Snatch Kit - Small Truck
	OAWINCHKIT	1	Winch Utility Kit

\*\* Complete range of Outback Armour recovery gear available at rear of this guide.

Notes:



**FORD RANGER PJ/PK**

9/2006 - 8/2011

**SUSPENSION KITS - FRONT****PERFORMANCE**

v

**ADJ. INTERNAL BYPASS**

v

**Trail**Lift front: OEM torsion bar (height adjustable)  
Suits vehicles with oem bumper or light front loads

OASU914900T \$350 kit	Not available for this vehicle	
2x OASU0160008 (shocks)		

**Expedition & Expedition HD**Lift front: Torsion bar (height adjustable)  
Suits vehicles with a steel bullbar, winch or heavy front loads

OASU914900E \$645 kit	Not available for this vehicle	
2x OASU0160008 (shocks)		

\* kit prices include shock absorbers listed above plus the following parts \*

1 pair OASU1211150 (torsion bars)

**SUSPENSION KITS - REAR**

<b>PERFORMANCE</b> v	<b>ADJ. INTERNAL BYPASS</b> v	
-------------------------	----------------------------------	--

Lift rear: 35mm (approx unladen)

**Trail** Suits vehicles with light or occasional medium loads

OASU924900T <b>\$1,155 kit</b>	Not available for this vehicle	
2x OASU0160009 (shocks)		

\* kit prices include shock absorbers listed above plus the following parts \*

4x OASU2388003 (u-bolts)	2x OASU1149001 (leaf springs)	2x OASU2500042 (pins)
1x OASU210020K (bush kit)		2x OASU2400054 (shackles)

Lift rear: 35mm (@ approx 250kg load)

**Expedition** Suits vehicles with constant medium or occasional heavy loads

OASU924900E <b>\$1,205 kit</b>	Not available for this vehicle	
2x OASU0160009 (shocks)		

\* kit prices include shock absorbers listed above plus the following parts \*

4x OASU2388001 (u-bolts)	2x OASU1149002 (leaf springs)	2x OASU2500042 (pins)
1x OASU210020K (bush kit)		2x OASU2400054 (shackles)

**RECOMMENDED OPTIONS & UPGRADES**

<b>Bump Stop Kit - Rear</b>	Parts included:
OASU4248004 <b>\$85 kit</b>	2x OASU4210104 (jounce stops) Rubber, extended progressive rate (110mm). Recommended to be installed in all vehicles with heavy rear loads.

Lift heights are approximate and may vary depending on vehicle & product tolerances and load distribution.

Ford Ranger PJ-PK / Mazda BT-50 Leaf Spring Deflection

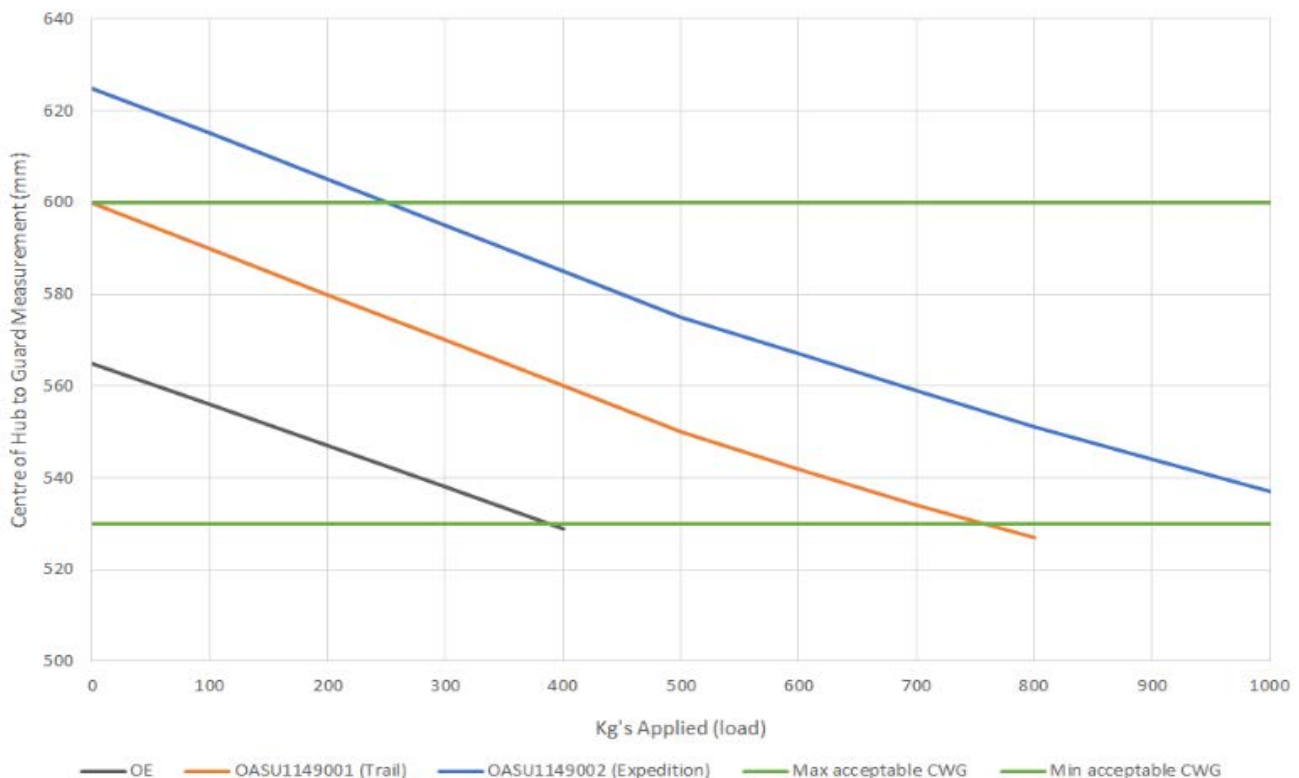



**FORD RANGER PX/PX2**

9/2011 +



PRODUCT	PART NO.	QTY	DETAILS
<b>Struts</b> Max CWG: 600	OASU0860005 \$220 ea.	2	<b>Performance</b> - 60mm twin tube. Spacer ring adjustable height spring seat. Complete set of rubber bushes, washers & dust boot included.
	OASU0865005-ADJ \$320 ea.	2	<b>Adjustable Internal Bypass</b> - 65mm twin tube. Threaded variable height spring seat. Complete set of rubber bushes, washers & dust boot included.
<b>Shock Absorbers</b>	OASU0160009L \$175 ea.	2	<b>Performance</b> - 60mm twin tube. Complete set of rubber bushes included. Steel shroud.
	OASU0165009L-ADJ \$220 ea.	2	<b>Adjustable Internal Bypass</b> - 65mm twin tube. Extended bump stops OASU4248004 must be fitted with this shock absorber.
<b>Coil Springs</b> (pair)	OASU1048001 \$260 pr.	1	Trail - 35mm lift (approx unladen, height adj. struts to 50mm) <i>For vehicles with added accessories, use the supplied spacer rings on struts to retain vehicle ride height.</i>
	OASU1048003 \$260 pr.	1	Expedition - 50mm lift (approx with bullbar) <i>For vehicles with added accessories, use the supplied spacer rings on struts to retain vehicle ride height. Suits bullbar &amp; winch.</i>
<b>Leaf Springs</b>	OASU1148005 \$250 ea.	2	Trail - 40mm lift (approx unladen) <i>3 primary + 2 secondary</i>
	OASU1148001 \$250 ea.	2	Expedition - 40mm lift (@ approx 150kg load) <i>3 primary + 2 secondary</i>
	OASU1148002 \$300 ea.	2	Expedition HD - 40mm lift (@ approx 300kg load) <i>4 primary + 2 secondary</i>
	OASU1148003 \$340 ea.	2	Expedition XHD - 40mm lift (@ approx 500kg load) <i>5 primary + 2 secondary</i>
<i>** Refer leaf spring graph following for approximate deflections under load.</i>			
<b>Leaf Spring Bush Kit</b>	OASU210028K \$200 kit	1	12 polyurethane bushes & 2 inner tubes
<b>U-bolts</b>	OASU2388004 \$15 ea.	4	Suits leaf springs: OASU1148001 & OASU1148005 <i>M14 x 88 ID (RND) x 190 L</i>
	OASU2388002 \$15 ea.	4	Suits leaf springs: OASU1148002 & OASU1148003 <i>M14 x 88 ID (RND) x 215 L</i>
<i>** All u-bolts hardened steel, rolled threads, deep nuts &amp; spring washers.</i>			
<b>Pins</b>	OASU2500042 \$20 ea.	2	Greasable, hardened steel
<b>Shackles</b>	OASU2400060 \$35 ea.	2	Greasable, hardened steel pins

**ACCESSORY ITEMS & CORRECTION COMPONENTS**

<b>Centre Bearing Spacer Kit</b>	OASU3748001 \$45 kit	1	Supplied with all required washers and spacers. Recommended to improve tailshaft angle and reduce vibrations.
<b>Bump Stops</b>	OASU4210102 \$27.50 ea.	2	Front - Rubber, extended progressive rate (60mm / Multi-fit).
	OASU4248004 \$85 kit	1	Rear - Rubber, extended progressive rate (2x 110mm).
<b>Strut Mount</b>	OASU0750001 \$80 ea.	2	Supplied with all required nuts, washers and bushes.

\* Ride heights approximate only, based on standard dual cab style-side ute with no additional load, unless otherwise stated.

\* A minimum of two thirds of the original suspension travel in each direction is retained for optimal performance and durability.



# FORD RANGER PX/PX2

9/2011 +



## SUSPENSION KITS - FRONT

**PERFORMANCE**

v

**ADJ. INTERNAL BYPASS**

v

### Trail

Lift front: 35mm (approx, height adjustable struts to 50mm)  
Suits vehicles with oem bumper or light front loads

OASU914800T \$700 kit	OASU914800T-ADJ \$900 kit	
2x OASU0860005 (struts)	2x OASU0865005-ADJ (struts)	

\* kit prices include struts listed above plus the following parts \*

1x OASU1048001 (coil springs)

Coil spring seat spacers included with struts for height adjustment.

### Expedition & Expedition HD

Lift front: 50mm (approx, height adjustable struts to 50mm)  
Suits vehicles with a steel bullbar, winch or heavy front loads

OASU914800E \$700 kit	OASU914800E-ADJ \$900 kit	
2x OASU0860005 (struts)	2x OASU0865005-ADJ (struts)	

\* kit prices include struts listed above plus the following parts \*

1x OASU1048003 (coil springs)

Coil spring seat spacers included with struts for height adjustment.

### ° Assembled Struts - Trail

Lift front: 50mm (@ approx 0-50kg load)  
Suits vehicles with oem bumper or light front loads

OASU934800T \$880 pr.	OASU934800T-ADJ \$1,080 pr.	
2x OASU394800T (each)	2x OASU394800T-ADJ (each)	

Assembled struts include: struts, coil springs & top mounts.

### ° Assembled Struts - Exped

Lift front: 50mm (@ approx 50-100kg load)  
Suits vehicles with a steel bullbar or medium front loads

OASU934800E \$880 pr.	OASU934800E-ADJ \$1,080 pr.	
2x OASU394800E (each)	2x OASU394800E-ADJ (each)	

Assembled struts include: struts, coil springs & top mounts.

### ° Assembled Struts - Exped HD

Lift front: 50mm (@ approx 100-150kg load)  
Suits vehicles with a steel bullbar & winch or heavy front loads

OASU934800H \$880 pr.	2x OASU934800H-ADJ \$1,080 pr.	
2x OASU394800H (each)	2x OASU394800H-ADJ (each)	

Assembled struts include: struts, coil springs & top mounts.

## RECOMMENDED OPTIONS & UPGRADES

### Jounce Stop Kit - Front

OASU4210202  
\$55 kit

Parts included:

2x OASU4210102 (jounce stops)  
Rubber, extended progressive rate (60mm / Multi-fit).  
Highly recommended to be installed in all vehicles with bullbars.

Lift heights are approximate and may vary depending on vehicle or product tolerances and load distribution.

# FORD RANGER PX/PX2

9/2011 +



## SUSPENSION KITS - REAR

PERFORMANCE v	ADJ. INTERNAL BYPASS v	
------------------	---------------------------	--

**Trail** Lift rear: 40mm (approx unladen)  
Suits vehicles with light or occasional medium loads

OASU924800T <b>\$1,265 kit</b>	OASU924800T-ADJ <b>\$1,355 kit</b>	
2x OASU0160009L (shocks)	2x OASU0165009L-ADJ (shocks)	

\* kit prices include shock absorbers listed above plus the following parts \*

1x OASU210028K (bush kit)	1x OASU3748001 (c/b spacer kit)	2x OASU2500042 (pins)
4x OASU2388004 (u-bolts)	2x OASU1148005 (leaf springs)	2x OASU2400060 (shackles)

Rear bump stop kit "OASU4248004" highly recommended to reduce risk of component damage at full compression.

**Expedition** Lift rear: 40mm (@ approx 150kg load)  
Suits vehicles with light or occasional medium loads

OASU924800E <b>\$1,265 kit</b>	OASU924800E-ADJ <b>\$1,355 kit</b>	
2x OASU0160009L (shocks)	2x OASU0165009L-ADJ (shocks)	

\* kit prices include shock absorbers listed above plus the following parts \*

1x OASU210028K (bush kit)	1x OASU3748001 (c/b spacer kit)	2x OASU2500042 (pins)
4x OASU2388004 (u-bolts)	2x OASU1148001 (leaf springs)	2x OASU2400060 (shackles)

Rear bump stop kit "OASU4248004" highly recommended to reduce risk of component damage at full compression.

**Expedition HD** Lift rear: 40mm (@ approx 300kg load)  
Suits vehicles with constant medium or occasional heavy loads

OASU924800H <b>\$1,365 kit</b>	OASU924800H-ADJ <b>\$1,455 kit</b>	
2x OASU0160009L (shocks)	2x OASU0165009L-ADJ (shocks)	

\* kit prices include shock absorbers listed above plus the following parts \*

1x OASU210028K (bush kit)	1x OASU3748001 (c/b spacer kit)	2x OASU2500042 (pins)
4x OASU2388002 (u-bolts)	2x OASU1148002 (leaf springs)	2x OASU2400060 (shackles)

Rear bump stop kit "OASU4248004" highly recommended to reduce risk of component damage at full compression.

**Expedition XHD** Lift rear: 40mm (@ approx 500kg load)  
Suits vehicles with constant heavy loads

OASU924800X <b>\$1,445 kit</b>	OASU924800X-ADJ <b>\$1,535 kit</b>	
2x OASU0160009L (shocks)	2x OASU0165009L-ADJ (shocks)	

\* kit prices include shock absorbers listed above plus the following parts \*

1x OASU210028K (bush kit)	1x OASU3748001 (c/b spacer kit)	2x OASU2500042 (pins)
4x OASU2388002 (u-bolts)	2x OASU1148003 (leaf springs)	2x OASU2400060 (shackles)

Rear bump stop kit "OASU4248004" highly recommended to reduce risk of component damage at full compression.

## RECOMMENDED OPTIONS & UPGRADES

<b>Jounce Stop Kit - Rear</b>	Parts included:
OASU4248004 <b>\$85 kit</b>	2x OASU4210104 (jounce stops) Rubber, extended progressive rate (110mm). Recommended to be installed in all vehicles with heavy rear loads.

Lift heights are approximate and may vary depending on vehicle & product tolerances and load distribution.

# FORD RANGER PX/PX2

9/2011 +



PRODUCT	PART NO.	DETAILS
Leaf Springs	OASU1148005	Trail - 40mm lift (approx unladen) 3 primary + 2 secondary
	OASU1148001	Expedition - 40mm lift (@ approx 150kg load) 3 primary + 2 secondary
	OASU1148002	Expedition HD - 40mm lift (@ approx 300kg load) 4 primary + 2 secondary
	OASU1148003	Expedition XHD - 40mm lift (@ approx 500kg load) 5 primary + 2 secondary

Ford Ranger PX-PXII / Mazda BT-50 Leaf Spring Deflection

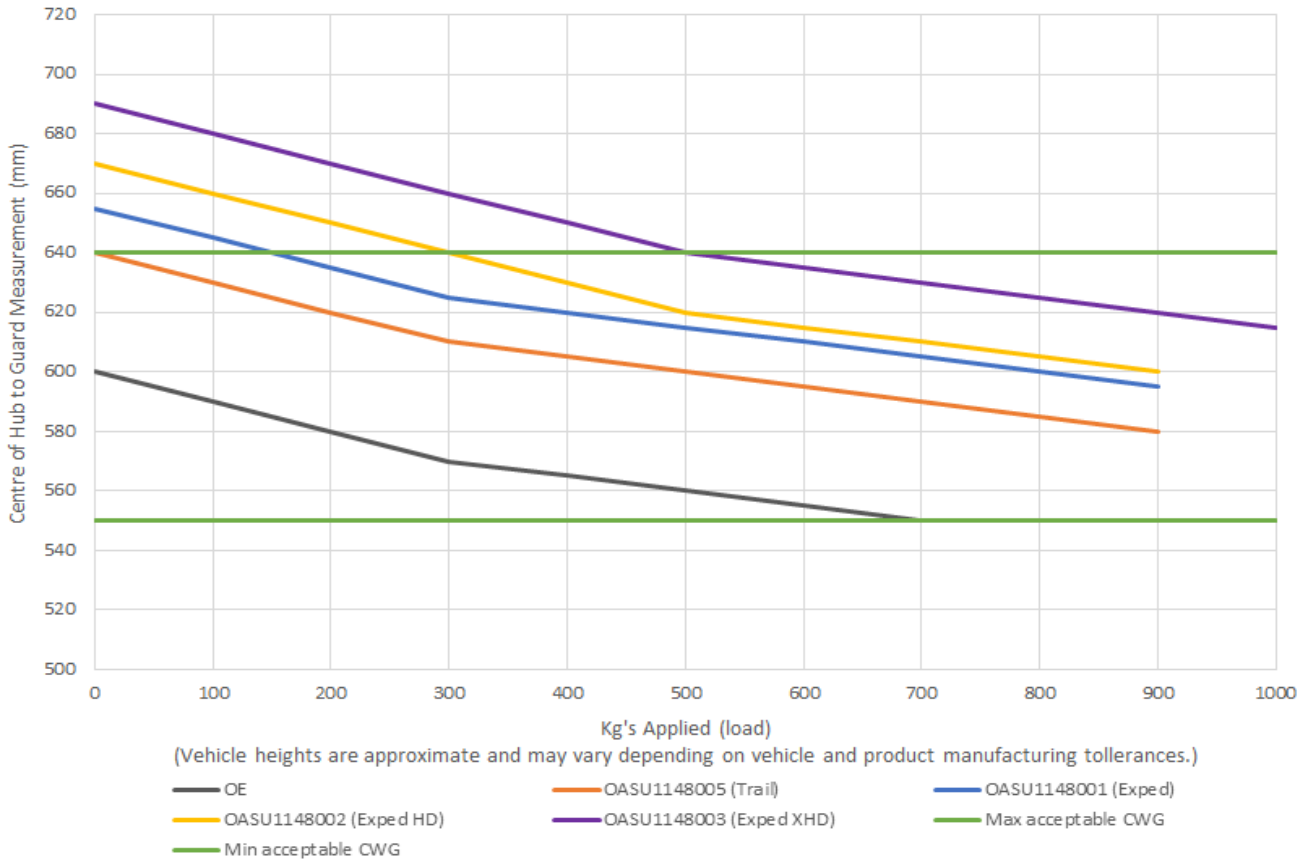

\* CWG (Centre Wheel to Guard) measured from centre of wheel to under-side of guard.

\* Max/Min Acceptable CWG are shown as a recommended guideline only.

\* CWG Heights approximate only, based on a standard dual cab style-side ute with no additional load.

Notes:

**FORD EVEREST**  
2015 +



PRODUCT	PART NO.	QTY	DETAILS
<b>Struts</b> Max CWG: 600	OASU0860005 \$220 ea.	2	<b>Performance</b> - 60mm twin tube. Spacer ring adjustable height spring seat. Complete set of rubber bushes, washers & dust boot included.
	OASU0865005-ADJ \$320 ea.	2	<b>Adjustable Internal Bypass</b> - 65mm twin tube. Threaded variable height spring seat. Complete set of rubber bushes, washers & dust boot included.
<b>Shock Absorbers</b>	OASU0160067 \$175 ea.	2	<b>Performance</b> - 60mm twin tube. Complete set of rubber bushes included. Steel shroud.
<b>Coil Springs</b> (front pair)	OASU1048001 \$260 pr.	1	Trail - 35mm lift (approx unladen, height adj. struts to 50mm) <i>For vehicles with added accessories, use the supplied spacer rings on struts to retain vehicle ride height.</i>
	OASU1048003 \$260 pr.	1	Expedition - 50mm lift (approx with bullbar) <i>For vehicles with added accessories, use the supplied spacer rings on struts to retain vehicle ride height. Suits bullbar &amp; winch.</i>
<b>Coil Springs</b> (rear pair)	OASU1048002 \$260 ea.	1	Trail - 50mm lift (approx unladen)
	OASU1048004 \$260 ea.	1	Expedition - 50mm lift (@approx 150 kg load)
	OASU1048006 \$275 ea.	1	Expedition HD - 50mm lift (@ approx 300kg load)
<b>ACCESSORY ITEMS &amp; CORRECTION COMPONENTS</b>			
<b>Bump Stops</b>	OASU4210102 \$27.50 ea.	2	Front - Rubber, extended progressive rate (60mm / Multi-fit).
<b>Strut Mount</b>	OASU0750001 \$80 ea.	2	Supplied with all required nuts, washers and bushes.

\* Ride heights approximate only, based on standard vehicle with no additional load, unless otherwise stated.

\* A minimum of two thirds of the original suspension travel in each direction is retained for optimal performance and durability.



**FORD EVEREST**

2015 +

**SUSPENSION KITS - FRONT****PERFORMANCE**

v

**ADJ. INTERNAL BYPASS**

v

**Trail**

Lift front: 35mm (approx, height adjustable struts to 50mm)

Suits vehicles with oem bumper or light front loads

OASU914800T \$700 kit	OASU914800T-ADJ \$900 kit	
2x OASU0860005 (struts)	2x OASU0865005-ADJ (struts)	

\* kit prices include struts listed above plus the following parts \*

1x OASU1048001 (coil springs)

Coil spring seat spacers included with struts for height adjustment.

**Expedition & Expedition HD**

Lift front: 50mm (approx, height adjustable struts to 50mm)

Suits vehicles with a steel bullbar, winch or heavy front loads

OASU914800E \$700 kit	OASU914800E-ADJ \$900 kit	
2x OASU0860005 (struts)	2x OASU0865005-ADJ (struts)	

\* kit prices include struts listed above plus the following parts \*

1x OASU1048003 (coil springs)

Coil spring seat spacers included with struts for height adjustment.

**° Assembled Struts - Trail**

Lift front: 50mm (@ approx 0-50 kg load)

Suits vehicles with oem bumper or light front loads

OASU934800T \$880 pr.	OASU934800T-ADJ \$1,080 pr.	
2x OASU394800T (each)	2x OASU394800T-ADJ (each)	

Assembled struts include: struts, coil springs &amp; top mounts.

**° Assembled Struts - Exped**

Lift front: 50mm (@ approx 50-100 kg load)

Suits vehicles with a steel bullbar or medium front loads

OASU934800E \$880 pr.	OASU934800E-ADJ \$1,080 pr.	
2x OASU394800E (each)	2x OASU394800E-ADJ (each)	

Assembled struts include: struts, coil springs &amp; top mounts.

**° Assembled Struts - Exped HD**

Lift front: 50mm (@ approx 100-150 kg load)

Suits vehicles with a steel bullbar &amp; winch or heavy front loads

OASU934800H \$880 pr.	2x OASU934800H-ADJ \$1,080 pr.	
2x OASU394800H (each)	2x OASU394800H-ADJ (each)	

Assembled struts include: struts, coil springs &amp; top mounts.

**RECOMMENDED OPTIONS & UPGRADES****Jounce Stop Kit - Front**OASU4210202  
\$55 kit

Parts included:

2x OASU4210102 (jounce stops)

Rubber, extended progressive rate (60mm / Multi-fit).

Highly recommended to be installed in all vehicles with bullbars.

Lift heights are approximate and may vary depending on vehicle or product tolerances and load distribution.

**FORD EVEREST**

2015 +

**SUSPENSION KITS - REAR**

PERFORMANCE v	ADJ. INTERNAL BYPASS v	
------------------	---------------------------	--

**Trail** Lift rear: 50mm (approx unladen)  
Suits vehicles with light or occasional medium loads

OASU924801T \$610 kit	Not available for this vehicle	
2x OASU0160067 (shocks)		

\* kit prices include shock absorbers listed above plus the following parts \*  
1x OASU1048002 (coil springs)

**Expedition** Lift rear: 50mm (@ approx 150kg load)  
Suits vehicles with constant medium or occasional heavy loads

OASU924801E \$610 kit	Not available for this vehicle	
2x OASU0160067 (shocks)		

\* kit prices include shock absorbers listed above plus the following parts \*  
1x OASU1048004 (coil springs)

**Expedition HD** Lift rear: 50mm (@ approx 300kg load)  
Suits vehicles with constant heavy loads

OASU924801H \$625 kit	Not available for this vehicle	
2x OASU0160067 (shocks)		

\* kit prices include shock absorbers listed above plus the following parts \*  
1x OASU1048006 (coil springs)

Lift heights are approximate and may vary depending on vehicle & product tolerances and load distribution.



# HOLDEN COLORADO RC

First Gen. 9/2008 - 7/2011, (inc. Holden RA Rodeo, Great Wall V200/V240)



PRODUCT	PART NO.	QTY	DETAILS
<b>Shock Absorbers</b> (front)	OASU0160010 \$175 ea.	2	<b>Performance</b> - 60mm twin tube. Complete set of rubber bushes, washers & dust boot incl.
<b>Shock Absorbers</b> (rear)	OASU0160030 \$175 ea.	2	<b>Performance</b> - 60mm twin tube. Complete set of rubber bushes included. Steel shroud.
	OASU0165030-ADJ \$220 ea.	2	<b>Adjustable Internal Bypass</b> - 65mm twin tube. Adjustable internal bypass. Complete set of rubber bushes & synthetic dust boot included.
<b>Torsion Bars</b> (pair)	OASU1211151 \$295 pr.	1	Trail / Expedition <i>Increased rate, 1140mm length, 30mm diameter.</i>
<b>Leaf Springs</b>	OASU1112001 \$235 ea.	2	Trail - 35mm lift (approx unladen) <i>4 primary + 2 secondary</i>
	OASU1112002 \$250 ea.	2	Expedition - 40mm lift (approx unladen) <i>5 primary + 2 secondary</i>
	OASU1112003 \$275 ea.	2	Expedition HD - 40mm lift (@ approx 300kg load) <i>6 primary + 2 secondary</i>
<i>** Refer leaf spring graph following for approximate deflections under load.</i>			
<b>Leaf Spring Bush Kit</b>	OASU210021K \$95 kit	1	12 polyurethane bushes & 2 inner tubes
<b>U-bolts</b>	OASU2388003 \$15 ea.	4	Suits leaf springs: OASU1112001 <i>M14 x 88 ID (RND) x 185 L</i>
	OASU2388004 \$15 ea.	4	Suits leaf springs: OASU1112002 <i>M14 x 88 ID (RND) x 190 L</i>
	OASU2388001 \$15 ea.	4	Suits leaf springs: OASU1112003 <i>M14 x 88 ID (RND) x 210 L</i>
<i>** All u-bolts hardened steel, rolled threads, deep nuts &amp; spring washers.</i>			
<b>Pins</b>	OASU2500042 \$20 ea.	2	Greasable, hardened steel
<b>Shackles</b>	OASU2400053 \$35 ea.	2	Greasable, hardened steel pins

## ACCESSORY ITEMS & CORRECTION COMPONENTS

<b>Bump Stops</b>	OASU4210004 \$165 kit	1	Rear - Rubber, extended progressive rate (2x 110mm).
-------------------	--------------------------	---	--

\* Ride heights approximate only, based on standard dual cab style-side ute with no additional load, unless otherwise stated.

\* Outback Armour recommend that a minimum of two thirds of the original suspension travel in each direction is retained for optimal performance and durability.

## RECOMMENDED RECOVERY GEAR

<b>Snatch Strap</b>	OASS6T9M	1	Dynamic Snatch Strap - 6T/9M (2.00T - 3.00T)
<b>Recovery Kits</b>	OAQUICKSKST	1	Quick Snatch Kit - Small Truck
	OACOMPSKST	1	Comp Snatch Kit - Small Truck
	OAWINCHKIT	1	Winch Utility Kit

\*\* Complete range of Outback Armour recovery gear available at rear of this guide.

Notes:



## HOLDEN COLORADO RC

First Gen. 9/2008 - 7/2011, (inc. Holden RA Rodeo, Great Wall V200/V240)



### SUSPENSION KITS - FRONT

PERFORMANCE v	ADJ. INTERNAL BYPASS v	
------------------	---------------------------	--

#### Trail

Lift front: OEM torsion bar (height adjustable)  
Suits vehicles with oem bumper or light front loads

OASU911300T \$350 kit	Not available for this vehicle	
2x OASU0160010 (shocks)		

#### Expedition & Expedition HD

Lift front: Torsion bar (height adjustable)  
Suits vehicles with a steel bullbar, winch or heavy front loads

OASU911300E \$645 kit	Not available for this vehicle	
2x OASU0160010 (shocks)		

\* kit prices include shock absorbers listed above plus the following parts \*

1 pair OASU1211151 (torsion bars)

# HOLDEN COLORADO RC

First Gen. 9/2008 - 7/2011, (inc. Holden RA Rodeo, Great Wall V200/V240)



## SUSPENSION KITS - REAR

PERFORMANCE v	ADJ. INTERNAL BYPASS v	
------------------	---------------------------	--

**Trail** Lift rear: 35mm (approx unladen)  
Suits vehicles with light or occasional medium loads

OASU921300T <b>\$1,085 kit</b>	OASU921300T-ADJ <b>\$1,175 kit</b>	
2x OASU0160030 (shocks)	2x OASU0165030-ADJ (shocks)	
* kit prices include shock absorbers listed above plus the following parts *		
1x OASU210021K (bush kit)	2x OASU1112001 (leaf springs)	2x OASU2500042 (pins)
4x OASU2388003 (u-bolts)		2x OASU2400053 (shackles)

**Expedition** Lift rear: 40mm (approx unladen)  
Suits vehicles with constant medium or occasional heavy loads

OASU921300E <b>\$1,115 kit</b>	OASU921300E-ADJ <b>\$1,205 kit</b>	
2x OASU0160030 (shocks)	2x OASU0165030-ADJ (shocks)	
* kit prices include shock absorbers listed above plus the following parts *		
1x OASU210021K (bush kit)	2x OASU1112002 (leaf springs)	2x OASU2500042 (pins)
4x OASU2388004 (u-bolts)		2x OASU2400053 (shackles)

**Expedition HD** Lift rear: 40mm (@ approx 300kg load)  
Suits vehicles with constant heavy loads

OASU921300H <b>\$1,165 kit</b>	OASU921300H-ADJ <b>\$1,255 kit</b>	
2x OASU0160030 (shocks)	2x OASU0165030-ADJ (shocks)	
* kit prices include shock absorbers listed above plus the following parts *		
1x OASU210021K (bush kit)	2x OASU1112003 (leaf springs)	2x OASU2500042 (pins)
4x OASU2388001 (u-bolts)		2x OASU2400053 (shackles)

## RECOMMENDED OPTIONS & UPGRADES

<b>Jounce Stop Kit - Rear</b>	Parts included:
OASU4210004 <b>\$165 kit</b>	2x OASU4210104 (jounce stops)      2x OASU4210103 (u-bolt plate)
	Rubber, extended progressive rate (110mm).
	Recommended to be installed in all vehicles with heavy rear loads.

Lift heights are approximate and may vary depending on vehicle & product tolerances and load distribution.

# HOLDEN COLORADO RC

First Gen. 9/2008 - 7/2011, (inc. Holden RA Rodeo, Great Wall V200/V240)



PRODUCT	PART NO.	DETAILS
	OASU1112001	Trail - 35mm lift (approx unladen) 4 primary + 2 secondary
	OASU1112002	Expedition - 40mm lift (@ approx unladen) 5 primary + 2 secondary
	OASU1112003	Expedition HD - 40mm lift (@ approx 300kg load) 6 primary + 2 secondary

Holden Colorado / Isuzu D-Max Pre 2011

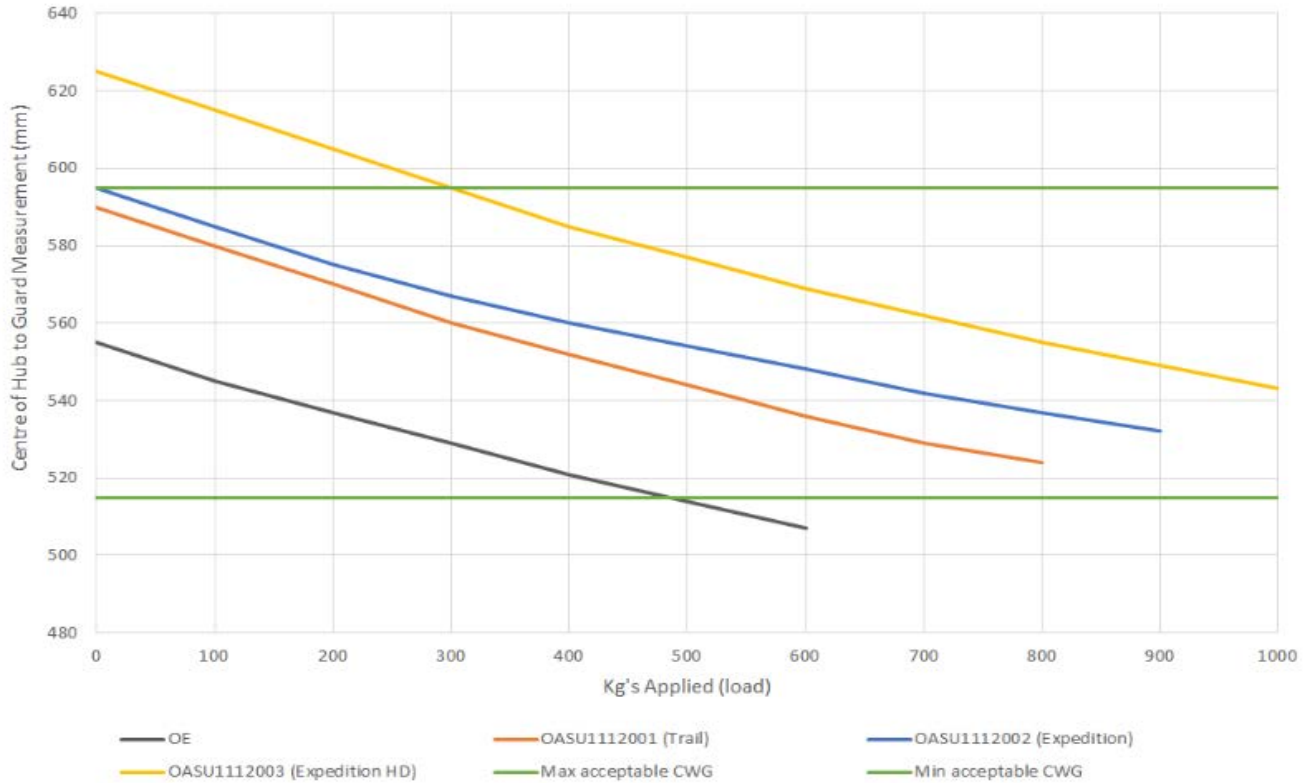

- \* CWG (Centre Wheel to Guard) measured from centre of wheel to under-side of guard.
- \* Max/Min Acceptable CWG are shown as a recommended guideline only.
- \* CWG Heights approximate only, based on a standard dual cab style-side ute with no additional load.

Notes:

**HOLDEN COLORADO RG**

8/2011 +



PRODUCT	PART NO.	QTY	DETAILS
<b>Struts</b> Max CWG: 575	OASU0860007 \$220 ea.	2	<b>Performance</b> - 60mm twin tube. Spacer ring adjustable height spring seat. Complete set of rubber bushes, washers & dust boot included. Strut mounts: refer notes hereunder.
	OASU0865007-ADJ \$320 ea.	2	<b>Adjustable Internal Bypass</b> - 65mm twin tube. Threaded variable height spring seat. Complete set of rubber bushes, washers & dust boot included. Strut mounts: refer notes hereunder.
<b>Shock Absorbers</b>	OASU0160042 \$175 ea.	2	<b>Performance</b> - 60mm twin tube. Complete set of rubber bushes included. Steel shroud.
	OASU0165042-ADJ \$220 ea.	2	<b>Adjustable Internal Bypass</b> - 65mm twin tube. Extended bump stops OASU4210004 must be fitted with this shock absorber.
<b>Coil Springs</b> (pair)	OASU1019001 \$260 pr.	1	Trail - 35mm lift (unladen, height adj. struts to 50mm) <i>For vehicles with added accessories, use the supplied spacer rings on struts to retain vehicle ride height.</i>
	OASU1015001 \$260 pr.	1	Expedition - 50mm lift (approx unladen) <i>For vehicles with added accessories, use the supplied spacer rings on struts to retain vehicle ride height. Suits bullbar &amp; winch.</i>
<b>Leaf Springs</b>	OASU1133001 \$275 ea.	2	Trail - 30mm lift (approx unladen) <i>4 primary + 2 secondary</i>
	OASU1133002 \$320 ea.	2	Expedition - 30mm lift (@ approx 150kg load) <i>5 primary + 2 secondary</i>
	OASU1134002 \$320 ea.	2	Expedition HD - 30mm lift (@ approx 300kg load) <i>5 primary + 2 secondary</i>
	OASU1134003 \$340 ea.	2	Expedition XHD - 30mm lift (@ approx 500kg load) <i>5 primary + 2 secondary</i>
<i>** Refer leaf spring graph following for approximate deflections under load.</i>			
<b>Leaf Spring Bush Kit</b>	OASU210027K \$130 kit	1	12 polyurethane bushes & 2 inner tubes
<b>U-bolts</b>	OASU2362001 \$15 ea.	4	Suits leaf springs: OASU1133001 <i>M14 x 62 ID (SQR) x 185 L</i>
	OASU2362002 \$15 ea.	4	Suits leaf springs: OASU1133002 <i>M14 x 62 ID (SQR) x 195 L</i>
	OASU2362004 \$15 ea.	4	Suits leaf spring: OASU1134002 & OASU1134003 <i>M14 x 62 ID (SQR) x 210 L</i>
<i>** All u-bolts hardened steel, rolled threads, deep nuts &amp; spring washers.</i>			
<b>Pins</b>	OASU2500042 \$20 ea.	2	Greasable, hardened steel
<b>Shackles</b>	OASU2400059 \$35 ea.	2	Greasable, hardened steel pins
<b>ACCESSORY ITEMS &amp; CORRECTION COMPONENTS</b>			
<b>Bump Stops</b>	OASU4210102 \$27.50 ea.	2	Front - Rubber, extended progressive rate (60mm / Multi-fit).
	OASU4210004 \$165 kit	1	Rear - Rubber, extended progressive rate (2x 110mm).
<b>Strut Mount</b>	OASU0719001 \$80 ea.	2	Supplied with all required nuts, washers and bushes.

\* OEM top strut mounts may suit either open or ground flat coil end designs (coil spring isolator stepped or flat design). Replacement top strut mounts with flat isolators may be required to fit aftermarket coil springs. Part: OASU0719001.

\* Ride heights approximate only, based on standard dual cab style-side ute with no additional load, unless otherwise stated.

\* A minimum of two thirds of the original suspension travel in each direction is retained for optimal performance and durability.



**HOLDEN COLORADO RG**

8/2011 +

**SUSPENSION KITS - FRONT****PERFORMANCE**

v

**ADJ. INTERNAL BYPASS**

v

**Trail**

Lift front: 35mm (approx, height adjustable struts to 50mm)

Suits vehicles with oem bumper or light front loads

OASU911900T \$700 kit	OASU911900T-ADJ \$900 kit	
2x OASU0860007 (struts)	2x OASU0865007-ADJ (struts)	

\* kit prices include struts listed above plus the following parts \*

1x OASU1019001 (coil springs)

Coil spring seat spacers included with struts for height adjustment.

**Expedition & Expedition HD**

Lift front: 50mm (approx, height adjustable struts to 50mm)

Suits vehicles with a steel bullbar, winch or heavy front loads

OASU911900E \$700 kit	OASU911900E-ADJ \$900 kit	
2x OASU0860007 (struts)	2x OASU0865007-ADJ (struts)	

\* kit prices include struts listed above plus the following parts \*

1x OASU1015001 (coil springs)

Coil spring seat spacers included with struts for height adjustment.

**° Assembled Struts - Trail**

Lift front: 50mm (@ approx 0-50kg load)

Suits vehicles with oem bumper or light front loads

OASU931900T \$880 pr.	OASU931900T-ADJ \$1,080 pr.	
2x OASU391900T (each)	2x OASU391900T-ADJ (each)	

Assembled struts include: struts, coil springs &amp; top mounts.

**° Assembled Struts - Exped**

Lift front: 50mm (@ approx 50-100kg load)

Suits vehicles with a steel bullbar or medium front loads

OASU931900E \$880 pr.	OASU931900E-ADJ \$1,080 pr.	
2x OASU391900E (each)	2x OASU391900E-ADJ (each)	

Assembled struts include: struts, coil springs &amp; top mounts.

**° Assembled Struts - Exped HD**

Lift front: 50mm (@ approx 100-150kg load)

Suits vehicles with a steel bullbar &amp; winch or heavy front loads

OASU931900H \$880 pr.	OASU931900H-ADJ \$1,080 pr.	
2x OASU391900H (each)	2x OASU391900H-ADJ (each)	

Assembled struts include: struts, coil springs &amp; top mounts.

**RECOMMENDED OPTIONS & UPGRADES****Jounce Stop Kit - Front**OASU4210202  
\$55 kit

Parts included:

2x OASU4210102 (jounce stops)

Rubber, extended progressive rate (60mm / Multi-fit).

Highly recommended to be installed in all vehicles with bullbars.

Lift heights are approximate and may vary depending on vehicle or product tolerances and load distribution.

**HOLDEN COLORADO RG**

8/2011 +

**SUSPENSION KITS - REAR**

PERFORMANCE v	ADJ. INTERNAL BYPASS v	
------------------	---------------------------	--

**Trail**Lift rear: 30mm (approx unladen)  
Suits vehicles with light or occasional medium loads

OASU921900T <b>\$1,200 kit</b>	OASU921900T-ADJ <b>\$1,455</b>	
2x OASU0160042 (shocks)	2x OASU0165042-ADJ (shocks) 1x OASU4210004 (bump stop kit)	

\* kit prices include shock absorbers listed above plus the following parts \*

1x OASU210027K (bush kit)	2x OASU1133001 (leaf springs)	2x OASU2500042 (pins)
4x OASU2362001 (u-bolts)		2x OASU2400059 (shackles)

Rear bump stop kit "OASU4210004" highly recommended to reduce risk of component damage at full compression.

**Expedition**Lift rear: 30mm (@ approx 150kg load)  
Suits vehicles with light or occasional medium loads

OASU921900E <b>\$1,290 kit</b>	OASU921900E-ADJ <b>\$1,380 kit</b>	
2x OASU0160042 (shocks)	2x OASU0165042-ADJ (shocks)	

\* kit prices include shock absorbers listed above plus the following parts \*

1x OASU210027K (bush kit)	2x OASU1133002 (leaf springs)	2x OASU2500042 (pins)
4x OASU2362002 (u-bolts)		2x OASU2400059 (shackles)

Rear bump stop kit "OASU4210004" highly recommended to reduce risk of component damage at full compression.

**Expedition HD**Lift rear: 30mm (@ approx 300kg load)  
Suits vehicles with constant medium or occasional heavy loads

OASU921900H <b>\$1,290 kit</b>	OASU921900H-ADJ <b>\$1,380 kit</b>	
2x OASU0160042 (shocks)	2x OASU0165042-ADJ (shocks)	

\* kit prices include shock absorbers listed above plus the following parts \*

1x OASU210027K (bush kit)	2x OASU1134002 (leaf springs)	2x OASU2500042 (pins)
4x OASU2362004 (u-bolts)		2x OASU2400059 (shackles)

Rear bump stop kit "OASU4210004" highly recommended to reduce risk of component damage at full compression.

**Expedition XHD**Lift rear: 30mm (@ approx 500kg load)  
Suits vehicles with constant heavy loads

OASU921900X <b>\$1,330 kit</b>	OASU921900X-ADJ <b>\$1,420 kit</b>	
2x OASU0160042 (shocks)	2x OASU0165042-ADJ (shocks)	

\* kit prices include shock absorbers listed above plus the following parts \*

1x OASU210027K (bush kit)	2x OASU1134003 (leaf springs)	2x OASU2500042 (pins)
4x OASU2362004 (u-bolts)		2x OASU2400059 (shackles)

Rear bump stop kit "OASU4210004" highly recommended to reduce risk of component damage at full compression.

**RECOMMENDED OPTIONS & UPGRADES**

<b>Jounce Stop Kit - Rear</b>	Parts included:
OASU4210004 <b>\$165 kit</b>	2x OASU4210104 (jounce stops)      2x OASU4210103 (u-bolt plate) Rubber, extended progressive rate (110mm). Recommended to be installed in all vehicles with heavy rear loads.

Lift heights are approximate and may vary depending on vehicle &amp; product tolerances and load distribution.

# HOLDEN COLORADO RG

8/2011 +



PRODUCT	PART NO.	DETAILS
Leaf Springs	OASU1133001	Trail - 30mm lift (approx unladen) 4 primary + 2 secondary
	OASU1133002	Expedition - 30mm lift (@ approx 150kg) 5 primary + 2 secondary
	OASU1134002	Expedition HD - 30mm lift (@ approx 300kg) 5 primary + 2 secondary
	OASU1134003	Expedition XHD - 30mm lift (@ approx 500kg load) 5 primary + 2 secondary

Holden Colorado RG Leaf Spring Deflection

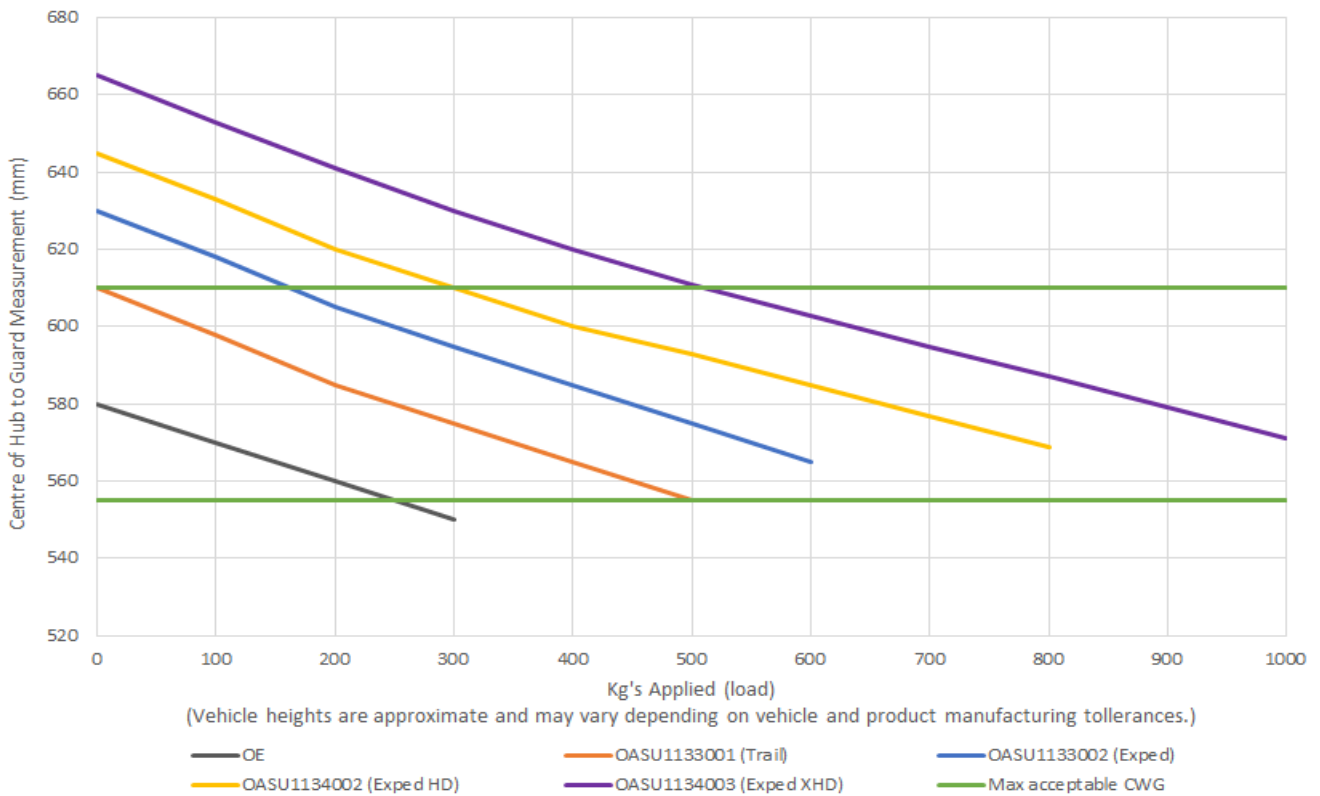

\* CWG (Centre Wheel to Guard) measured from centre of wheel to under-side of guard.

\* Max/Min Acceptable CWG are shown as a recommended guideline only.

\* CWG Heights approximate only, based on a standard dual cab style-side ute with no additional load.

Notes:

# HOLDEN COLORADO 7

2012 - 2017 (& Trailblazer 2017+)



PRODUCT	PART NO.	QTY	DETAILS
<b>Struts</b> Max CWG: 575	OASU0860007 \$220 ea.	2	<b>Performance</b> - 60mm twin tube. Spacer ring adjustable height spring seat. Complete set of rubber bushes, washers & dust boot included. Strut mounts: refer notes hereunder.
	OASU0865007-ADJ \$320 ea.	2	<b>Adjustable Internal Bypass</b> - 65mm twin tube. Threaded variable height spring seat. Complete set of rubber bushes, washers & dust boot included. Strut mounts: refer notes hereunder.
<b>Shock Absorbers</b>	OASU0160056 \$175 ea.	2	<b>Performance</b> - 60mm twin tube. Complete set of rubber bushes included. Steel shroud.
<b>Coil Springs Front</b> (pair)	OASU1019001 \$260 pr.	1	Trail - 35mm lift (approx unladen, height adj. struts to 50mm) <i>Suits vehicles with no front accessories.</i> <i>Springs seat spacers supplied with struts to adjust ride height.</i>
	OASU1015001 \$260 pr.	1	Expedition & Expedition HD - 50mm lift (approx unladen) <i>Suits vehicles with bullbars and medium front loads.</i> <i>Springs seat spacers supplied with struts to adjust ride height.</i>
<b>Coil Springs Rear</b> (pair)	OASU1034002 \$260 ea.	1	Trail - 35mm lift (approx unladen)
	OASU1034004 \$260 ea.	1	Expedition - 35mm lift (@ approx 150kg load)

## ACCESSORY ITEMS & CORRECTION COMPONENTS

<b>Bump Stops</b>	OASU4210102 \$27.50 ea.	2	Front - Rubber, extended progressive rate (60mm / Multi-fit).
<b>Strut Mount</b>	OASU0719001 \$80 ea.	2	Supplied with all required nuts, washers and bushes.

\* OEM top strut mounts may suit either open or ground flat coil end designs (coil spring isolator stepped or flat design).

Replacement top strut mounts with flat isolators may be required to fit aftermarket coil springs. Part: OASU0719001.

\* Ride heights approximate only, based on standard dual cab style-side ute with no additional load, unless otherwise stated.

\* Outback Armour recommend that a minimum of two thirds of the original suspension travel in each direction is retained for optimal performance and durability.

## RECOMMENDED RECOVERY GEAR

<b>Snatch Strap</b>	OASS6T9M	1	Dynamic Snatch Strap - 6T/9M (2.00T - 3.00T)
<b>Recovery Kits</b>	OAQUICKSKST	1	Quick Snatch Kit - Small Truck
	OACOMPSKST	1	Comp Snatch Kit - Small Truck
	OAWINCHKIT	1	Winch Utility Kit

\*\* Complete range of Outback Armour recovery gear available at rear of this guide.

Notes:

**HOLDEN COLORADO 7**

2012 - 2017 (&amp; Trailblazer 2017+)

**SUSPENSION KITS - FRONT****PERFORMANCE**

v

**ADJ. INTERNAL BYPASS**

v

**Trail**

Lift front: 35mm (approx, height adjustable struts to 50mm)

Suits vehicles with oem bumper or light front loads

OASU911900T \$700 kit	OASU911900T-ADJ \$900 kit	
2x OASU0860007 (struts)	2x OASU0865007-ADJ (struts)	

\* kit prices include struts listed above plus the following parts \*

1x OASU1019001 (coil springs)

Coil spring seat spacers included with struts for height adjustment.

**Expedition & Expedition HD**

Lift front: 50mm (approx, height adjustable struts to 50mm)

Suits vehicles with a steel bullbar, winch or heavy front loads

OASU911900E \$700 kit	OASU911900E-ADJ \$900 kit	
2x OASU0860007 (struts)	2x OASU0865007-ADJ (struts)	

\* kit prices include struts listed above plus the following parts \*

1x OASU1015001 (coil springs)

Coil spring seat spacers included with struts for height adjustment.

**° Assembled Struts - Trail**

Lift front: 50mm (@ approx 0-50kg load)

Suits vehicles with oem bumper or light front loads

OASU931900T \$880 pr.	OASU931900T-ADJ \$1,080 pr.	
2x OASU391900T (each)	2x OASU391900T-ADJ (each)	

Assembled struts include: struts, coil springs &amp; top mounts.

**° Assembled Struts - Exped**

Lift front: 50mm (@ approx 50-100kg load)

Suits vehicles with a steel bullbar or medium front loads

OASU931900E \$880 pr.	OASU931900E-ADJ \$1,080 pr.	
2x OASU391900E (each)	2x OASU391900E-ADJ (each)	

Assembled struts include: struts, coil springs &amp; top mounts.

**° Assembled Struts - Exped HD**

Lift front: 50mm (@ approx 100-150kg load)

Suits vehicles with a steel bullbar &amp; winch or heavy front loads

OASU931900H \$880 pr.	OASU931900H-ADJ \$1,080 pr.	
2x OASU391900H (each)	2x OASU391900H-ADJ (each)	

Assembled struts include: struts, coil springs &amp; top mounts.

**RECOMMENDED OPTIONS & UPGRADES****Jounce Stop Kit - Front**OASU4210202  
\$55 kit

Parts included:

2x OASU4210102 (jounce stops)

Rubber, extended progressive rate (60mm / Multi-fit).

Highly recommended to be installed in all vehicles with bullbars.

Lift heights are approximate and may vary depending on vehicle or product tolerances and load distribution.

# HOLDEN COLORADO 7

2012 - 2017 (& Trailblazer 2017+)



## SUSPENSION KITS - REAR

**PERFORMANCE**  
v

**ADJ. INTERNAL BYPASS**  
v

### Trail

Lift rear: 35mm (approx unladen)  
Suits vehicles with light or occasional medium loads

OASU921901T \$610 kit	Not available for this vehicle	
2x OASU0160056 (shocks)		

\* kit prices include shock absorbers listed above plus the following parts \*  
1x OASU1034002 (coil springs)

### Expedition

Lift rear: 35mm (@ approx 150kg load)  
Suits vehicles with constant medium or occasional heavy loads

OASU921901E \$610 kit	Not available for this vehicle	
2x OASU0160056 (shocks)		

\* kit prices include shock absorbers listed above plus the following parts \*  
1x OASU1034004 (coil springs)

Lift heights are approximate and may vary depending on vehicle & product tolerances and load distribution.





# ISUZU D-MAX

7/2008 - 9/2012



PRODUCT	PART NO.	QTY	DETAILS
<b>Shock Absorbers</b> (front)	OASU0160010 \$175 ea.	2	<b>Performance</b> - 60mm twin tube. Complete set of rubber bushes, washers & dust boot incl.
<b>Shock Absorbers</b> (rear)	OASU0160030 \$175 ea.	2	<b>Performance</b> - 60mm twin tube. Complete set of rubber bushes included. Steel shroud.
	OASU0165030-ADJ \$220 ea.	2	<b>Adjustable Internal Bypass</b> - 65mm twin tube. Adjustable internal bypass. Complete set of rubber bushes & synthetic dust boot included.
<b>Torsion Bars</b> (pair)	OASU1211151 \$295 pr.	1	Trail / Expedition <i>Increased rate, 1140mm length, 30mm diameter.</i>
<b>Leaf Springs</b>	OASU1112001 \$235 ea.	2	Trail - 35mm lift (approx unladen) <i>4 primary + 2 secondary</i>
	OASU1112002 \$250 ea.	2	Expedition - 40mm lift (approx unladen) <i>5 primary + 2 secondary</i>
	OASU1112003 \$275 ea.	2	Expedition HD - 40mm lift (@ approx 300kg load) <i>6 primary + 2 secondary</i>
<i>** Refer leaf spring graph following for approximate deflections under load.</i>			
<b>Leaf Spring Bush Kit</b>	OASU210021K \$95 kit	1	12 polyurethane bushes & 2 inner tubes
<b>U-bolts</b>	OASU2388003 \$15 ea.	4	Suits leaf springs: OASU1112001 <i>M14 x 88 ID (RND) x 185 L</i>
	OASU2388004 \$15 ea.	4	Suits leaf springs: OASU1112002 <i>M14 x 88 ID (RND) x 190 L</i>
	OASU2388001 \$15 ea.	4	Suits leaf springs: OASU1112003 <i>M14 x 88 ID (RND) x 210 L</i>
<i>** All u-bolts hardened steel, rolled threads, deep nuts &amp; spring washers.</i>			
<b>Pins</b>	OASU2500042 \$20 ea.	2	Greasable, hardened steel
<b>Shackles</b>	OASU2400053 \$35 ea.	2	Greasable, hardened steel pins

## ACCESSORY ITEMS & CORRECTION COMPONENTS

<b>Bump Stops</b>	OASU4210004 \$165 kit	1	Rear - Rubber, extended progressive rate (2x 110mm).
-------------------	--------------------------	---	--

\* Ride heights approximate only, based on standard dual cab style-side ute with no additional load, unless otherwise stated.

\* Outback Armour recommend that a minimum of two thirds of the original suspension travel in each direction is retained for optimal performance and durability.

## RECOMMENDED RECOVERY GEAR

<b>Snatch Strap</b>	OASS6T9M	1	Dynamic Snatch Strap - 6T/9M (2.00T - 3.00T)
<b>Recovery Kits</b>	OAQUICKSKST	1	Quick Snatch Kit - Small Truck
	OACOMPSKST	1	Comp Snatch Kit - Small Truck
	OAWINCHKIT	1	Winch Utility Kit

*\*\* Complete range of Outback Armour recovery gear available at rear of this guide.*

Notes:

**ISUZU D-MAX**

7/2008 - 9/2012

**SUSPENSION KITS - FRONT**

PERFORMANCE v	ADJ. INTERNAL BYPASS v	
------------------	---------------------------	--

**Trail**

Lift front: OEM torsion bar (height adjustable)  
Suits vehicles with oem bumper or light front loads

OASU911300T \$350 kit	Not available for this vehicle	
2x OASU0160010 (shocks)		

**Expedition & Expedition HD**

Lift front: Torsion bar (height adjustable)  
Suits vehicles with a steel bullbar, winch or heavy front loads

OASU911300E \$645 kit	Not available for this vehicle	
2x OASU0160010 (shocks)		

\* kit prices include shock absorbers listed above plus the following parts \*

1 pair OASU1211151 (torsion bars)

**ISUZU D-MAX**

7/2008 - 9/2012

**SUSPENSION KITS - REAR****PERFORMANCE**

v

**ADJ. INTERNAL BYPASS**

v

**Trail**

Lift rear: 35mm (approx unladen)

Suits vehicles with light or occasional medium loads

OASU921300T <b>\$1,085 kit</b>	OASU921300T-ADJ <b>\$1,175 kit</b>	
2x OASU0160030 (shocks)	2x OASU0165030-ADJ (shocks)	
* kit prices include shock absorbers listed above plus the following parts *		
1x OASU210021K (bush kit)	2x OASU1112001 (leaf springs)	2x OASU2500042 (pins)
4x OASU2388003 (u-bolts)		2x OASU2400053 (shackles)

**Expedition**

Lift rear: 40mm (approx unladen)

Suits vehicles with constant medium or occasional heavy loads

OASU921300E <b>\$1,115 kit</b>	OASU921300T-ADJ <b>\$1,205 kit</b>	
2x OASU0160030 (shocks)	2x OASU0165030-ADJ (shocks)	
* kit prices include shock absorbers listed above plus the following parts *		
1x OASU210021K (bush kit)	2x OASU1112002 (leaf springs)	2x OASU2500042 (pins)
4x OASU2388004 (u-bolts)		2x OASU2400053 (shackles)

**Expedition HD**

Lift rear: 40mm (@ approx 300kg load)

Suits vehicles with constant heavy loads

OASU921300H <b>\$1,165 kit</b>	OASU921300T-ADJ <b>\$1,255 kit</b>	
2x OASU0160030 (shocks)	2x OASU0165030-ADJ (shocks)	
* kit prices include shock absorbers listed above plus the following parts *		
1x OASU210021K (bush kit)	2x OASU1112003 (leaf springs)	2x OASU2500042 (pins)
4x OASU2388001 (u-bolts)		2x OASU2400053 (shackles)

**RECOMMENDED OPTIONS & UPGRADES**

<b>Jounce Stop Kit - Rear</b>	Parts included:
OASU4210004 <b>\$165 kit</b>	2x OASU4210104 (jounce stops)      2x OASU4210103 (u-bolt plate)
	Rubber, extended progressive rate (110mm).
	Recommended to be installed in all vehicles with heavy rear loads.

Lift heights are approximate and may vary depending on vehicle &amp; product tolerances and load distribution.

# ISUZU D-MAX

7/2008 - 9/2012



PRODUCT	PART NO.	DETAILS
	OASU1112001	Trail - 35mm lift (approx unladen) 4 primary + 2 secondary
	OASU1112002	Expedition - 40mm lift (@ approx unladen) 5 primary + 2 secondary
	OASU1112003	Expedition HD - 40mm lift (@ approx 300kg load) 6 primary + 2 secondary

Holden Colorado / Isuzu D-Max Pre 2011

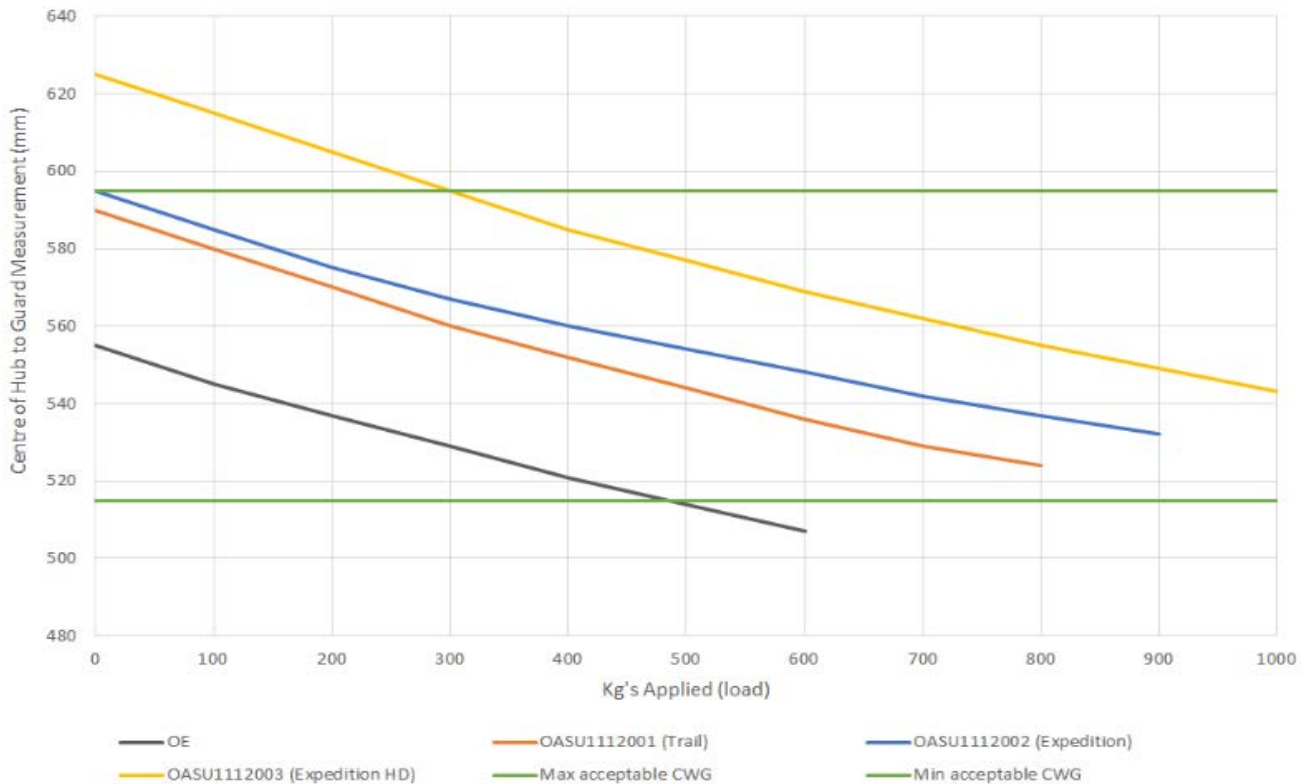

\* CWG (Centre Wheel to Guard) measured from centre of wheel to under-side of guard.

\* Max/Min Acceptable CWG are shown as a recommended guideline only.

\* CWG Heights approximate only, based on a standard dual cab style-side ute with no additional load.

Notes:

PRODUCT	PART NO.	QTY	DETAILS
<b>Struts</b> Max CWG: 575	OASU0860007 \$220 ea.	2	<b>Performance</b> - 60mm twin tube. Spacer ring adjustable height spring seat. Complete set of rubber bushes, washers & dust boot included.
	OASU0865007-ADJ \$320 ea.	2	<b>Adjustable Internal Bypass</b> - 65mm twin tube. Threaded variable height spring seat. Complete set of rubber bushes, washers & dust boot included.
<b>Shock Absorbers</b>	OASU0160042 \$175 ea.	2	<b>Performance</b> - 60mm twin tube. Complete set of rubber bushes included. Steel shroud.
	OASU0165042-ADJ \$220 ea.	2	<b>Adjustable Internal Bypass</b> - 65mm twin tube. Complete set of rubber bushes & dust boot included.
<b>Coil Springs</b> (pair)	OASU1019001 \$260 pr.	1	Trail - 35mm lift (approx unladen, height adj. struts to 50mm) <i>Suits vehicles with no front accessories. Springs seat spacers supplied with struts to adjust ride height.</i>
	OASU1015001 \$260 pr.	1	Expedition - 50mm lift (approx unladen) <i>Suits vehicles with bullbars and medium front loads. Springs seat spacers supplied with struts to adjust ride height.</i>
<b>Leaf Springs</b>	OASU1133001 \$275 ea.	2	Trail - 50mm lift (approx unladen) <i>4 primary + 2 secondary</i>
	OASU1133002 \$320 ea.	2	Expedition - 50mm lift (@ approx 150kg load) <i>5 primary + 2 secondary</i>
	OASU1134002 \$320 ea.	2	Expedition HD- 50mm lift (@ approx 300kg load) <i>5 primary + 2 secondary</i>
	OASU1134003 \$340 ea.	2	Expedition XHD- 50mm lift (@ approx 500kg load) <i>5 primary + 2 secondary</i>
<i>** Refer leaf spring graph following for approximate deflections under load.</i>			
<b>Leaf Spring Bush Kit</b>	OASU210027K \$130 kit	1	12 polyurethane bushes & 2 inner tubes
<b>U-bolts</b>	OASU2362001 \$15 ea.	4	Suits leaf springs: OASU1133001 <i>M14 x 62 ID (SQR) x 185 L</i>
	OASU2362002 \$15 ea.	4	Suits leaf springs: OASU1134001 <i>M14 x 62 ID (SQR) x 195 L</i>
	OASU2362004 \$15 ea.	4	Suits leaf springs: OASU1134002 & OASU1134003 <i>M14 x 62 ID (SQR) x 210 L</i>
<i>** All u-bolts hardened steel, rolled threads, deep nuts &amp; spring washers.</i>			
<b>Pins</b>	OASU2500042 \$20 ea.	2	Greasable, hardened steel
<b>Shackles</b>	OASU2400059 \$35 ea.	2	Greasable, hardened steel pins

**ACCESSORY ITEMS & CORRECTION COMPONENTS**

<b>Bump Stops</b>	OASU4210102 \$27.50 ea.	2	Front - Rubber, extended progressive rate (60mm / Multi-fit).
	OASU4210004 \$165 kit	1	Rear - Rubber, extended progressive rate (2x 110mm).
<b>Strut Mount</b>	OASU0719001 \$80 ea.	2	Supplied with all required nuts, washers and bushes.

\* Ride heights approximate only, based on standard dual cab style-side ute with no additional load, unless otherwise stated.

\* A minimum of two thirds of the original suspension travel in each direction is retained for optimal performance and durability.



**ISUZU D-MAX**

2012 +

**SUSPENSION KITS - FRONT****PERFORMANCE**

v

**ADJ. INTERNAL BYPASS**

v

**Trail**

Lift front: 35mm (approx, height adjustable struts to 50mm)

Suits vehicles with oem bumper or light front loads

OASU911900T \$700 kit	OASU911900T-ADJ \$900 kit	
2x OASU0860007 (struts)	2x OASU0865007-ADJ (struts)	

\* kit prices include struts listed above plus the following parts \*

1x OASU1019001 (coil springs)

Coil spring seat spacers included with struts for height adjustment.

**Expedition & Expedition HD**

Lift front: 50mm (approx, height adjustable struts to 50mm)

Suits vehicles with a steel bullbar, winch or heavy front loads

OASU911900E \$700 kit	OASU911900E-ADJ \$900 kit	
2x OASU0860007 (struts)	2x OASU0865007-ADJ (struts)	

\* kit prices include struts listed above plus the following parts \*

1x OASU1015001 (coil springs)

Coil spring seat spacers included with struts for height adjustment.

**° Assembled Struts - Trail**

Lift front: 50mm (@ approx 0-50kg load)

Suits vehicles with oem bumper or light front loads

OASU931900T \$880 pr.	OASU931900T-ADJ \$1,080 pr.	
2x OASU391900T (each)	2x OASU391900T-ADJ (each)	

Assembled struts include: struts, coil springs &amp; top mounts.

**° Assembled Struts - Exped**

Lift front: 50mm (@ approx 50-100kg load)

Suits vehicles with a steel bullbar or medium front loads

OASU931900E \$880 pr.	OASU931900E-ADJ \$1,080 pr.	
2x OASU391900E (each)	2x OASU391900E-ADJ (each)	

Assembled struts include: struts, coil springs &amp; top mounts.

**° Assembled Struts - Exped HD**

Lift front: 50mm (@ approx 100-150kg load)

Suits vehicles with a steel bullbar &amp; winch or heavy front loads

OASU931900H \$880 pr.	OASU931900H-ADJ \$1,080 pr.	
2x OASU391900H (each)	2x OASU391900H-ADJ (each)	

Assembled struts include: struts, coil springs &amp; top mounts.

**RECOMMENDED OPTIONS & UPGRADES****Jounce Stop Kit - Front**OASU4210202  
\$55 kit

Parts included:

2x OASU4210102 (jounce stops)

Rubber, extended progressive rate (60mm / Multi-fit).

Highly recommended to be installed in all vehicles with bullbars.

Lift heights are approximate and may vary depending on vehicle or product tolerances and load distribution.

**ISUZU D-MAX**

2012 +

**SUSPENSION KITS - REAR****PERFORMANCE**

v

**ADJ. INTERNAL BYPASS**

v

**Trail**Lift rear: 50mm (approx unladen)  
Suits vehicles with light or occasional medium loads

OASU923300T \$1,200 kit	OASU923300T-ADJ \$1,290 kit	
2x OASU0160042 (shocks)	2x OASU0165042-ADJ (shocks)	

\* kit prices include shock absorbers listed above plus the following parts \*

1x OASU210027K (bush kit)	2x OASU1133001 (leaf springs)	2x OASU2500042 (pins)
4x OASU2362001 (u-bolts)		2x OASU2400059 (shackles)

Rear bump stop kit "OASU4210004" highly recommended to reduce risk of component damage at full compression.

**Expedition**Lift rear: 50mm (@ approx 150kg load)  
Suits vehicles with constant medium or occasional heavy loads

OASU923300E \$1,290 kit	OASU923300E-ADJ \$1,380 kit	
2x OASU0160042 (shocks)	2x OASU0165042-ADJ (shocks)	

\* kit prices include shock absorbers listed above plus the following parts \*

1x OASU210027K (bush kit)	2x OASU1133002 (leaf springs)	2x OASU2500042 (pins)
4x OASU2362002 (u-bolts)		2x OASU2400059 (shackles)

Rear bump stop kit "OASU4210004" highly recommended to reduce risk of component damage at full compression.

**Expedition HD**Lift rear: 50mm (@ approx 300kg load)  
Suits vehicles with constant heavy loads

OASU923300H \$1,290 kit	OASU923300H-ADJ \$1,380 kit	
2x OASU0160042 (shocks)	2x OASU0165042-ADJ (shocks)	

\* kit prices include shock absorbers listed above plus the following parts \*

1x OASU210027K (bush kit)	2x OASU1134002 (leaf springs)	2x OASU2500042 (pins)
4x OASU2362004 (u-bolts)		2x OASU2400059 (shackles)

Rear bump stop kit "OASU4210004" highly recommended to reduce risk of component damage at full compression.

**Expedition XHD**Lift rear: 50mm (@ approx 500kg load)  
Suits vehicles with constant heavy loads

OASU923300X \$1,330 kit	OASU923300X-ADJ \$1,420 kit	
2x OASU0160042 (shocks)	2x OASU0165042-ADJ (shocks)	

\* kit prices include shock absorbers listed above plus the following parts \*

1x OASU210027K (bush kit)	2x OASU1134003 (leaf springs)	2x OASU2500042 (pins)
4x OASU2362004 (u-bolts)		2x OASU2400059 (shackles)

Rear bump stop kit "OASU4210004" highly recommended to reduce risk of component damage at full compression.

**RECOMMENDED OPTIONS & UPGRADES**

<b>Jounce Stop Kit - Rear</b>	Parts included:
OASU4210004 \$165 kit	2x OASU4210104 (jounce stops)      2x OASU4210103 (u-bolt plate) Rubber, extended progressive rate (110mm). Recommended to be installed in all vehicles with heavy rear loads.

Lift heights are approximate and may vary depending on vehicle &amp; product tolerances and load distribution.

PRODUCT	PART NO.	DETAILS
Leaf Springs	OASU1133001	Trail - 50mm lift (approx unladen) <i>4 primary + 2 secondary</i>
	OASU1133002	Expedition - 50mm lift (@ approx 150kg load) <i>5 primary + 2 secondary</i>
	OASU1134002	Expedition - 50mm lift (@ approx 300kg load) <i>5 primary + 2 secondary</i>
	OASU1134003	Expedition HD - 50mm lift (@ approx 500kg load) <i>5 primary + 2 secondary</i>

Isuzu D-Max 2012+ Leaf Spring Deflection

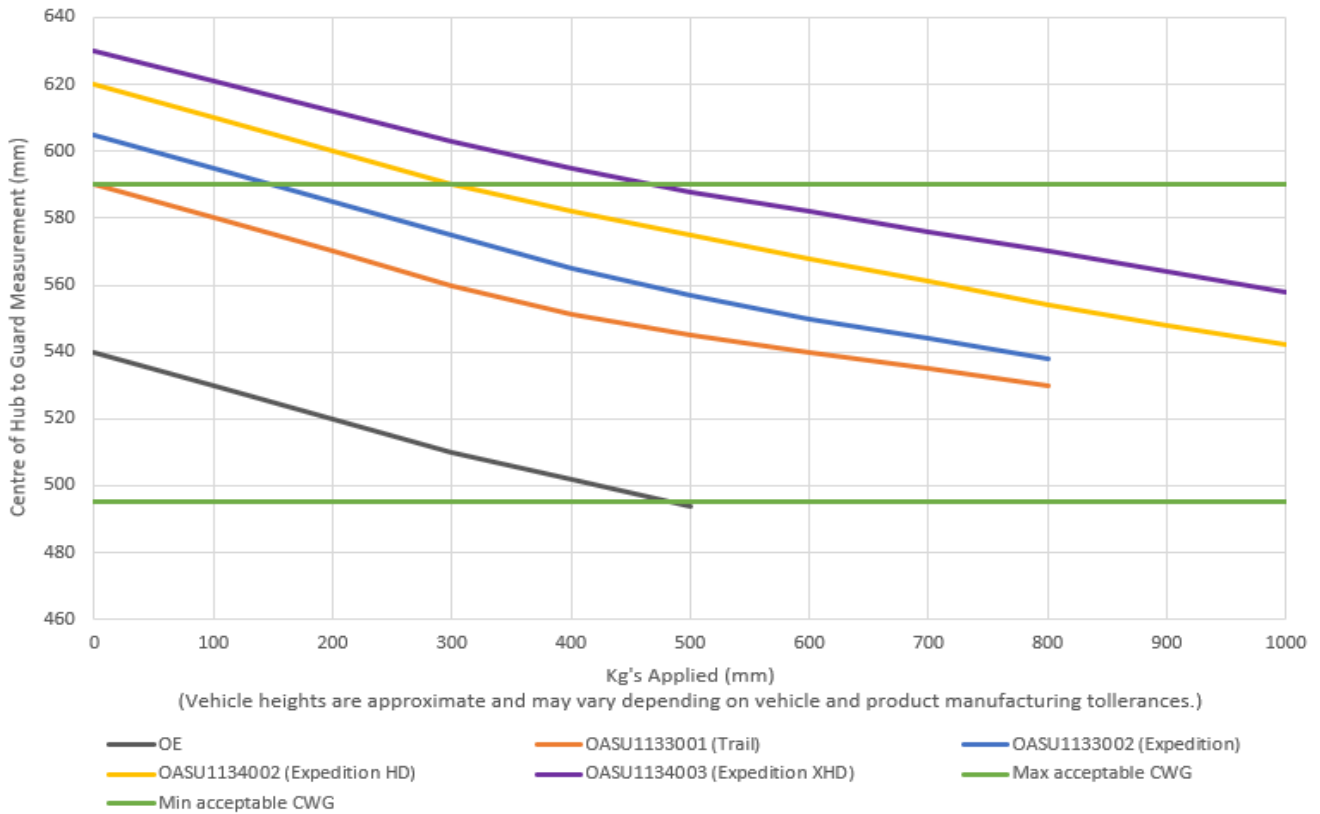

- \* CWG (Centre Wheel to Guard) measured from centre of wheel to under-side of guard.
- \* Max/Min Acceptable CWG are shown as a recommended guideline only.
- \* CWG Heights approximate only, based on a standard dual cab style-side ute with no additional load.

Notes:

**ISUZU MU-X**

9/2013 +



PRODUCT	PART NO.	QTY	DETAILS
<b>Struts</b> Max CWG: 565	OASU0860007 \$220 ea.	2	<b>Performance</b> - 60mm twin tube. Spacer ring adjustable height spring seat. Complete set of rubber bushes, washers & dust boot included.
	OASU0865007-ADJ \$320 ea.	2	<b>Adjustable Internal Bypass</b> - 65mm twin tube. Threaded variable height spring seat. Complete set of rubber bushes, washers & dust boot included.
<b>Shock Absorbers</b>	OASU0160056 \$175 ea.	2	<b>Performance</b> - 60mm twin tube. Complete set of rubber bushes included. Steel shroud.
<b>Coil Springs Front</b> (pair)	OASU1019001 \$260 pr.	1	Trail - 35mm lift (approx unladen, height adj. struts to 50mm) <i>Suits vehicles with no front accessories. Springs seat spacers supplied with struts to adjust ride height.</i>
	OASU1015001 \$260 pr.	1	Expedition & Expedition HD - 50mm lift (approx unladen) <i>Suits vehicles with bullbars and medium front loads. Springs seat spacers supplied with struts to adjust ride height.</i>
<b>Coil Springs Rear</b> (pair)	OASU1033002 \$260 ea.	1	Trail - 35mm lift (approx unladen)
	OASU1033004 \$260 ea.	1	Expedition - 35mm lift (@ approx 150kg load)

**ACCESSORY ITEMS & CORRECTION COMPONENTS**

<b>Bump Stops</b>	OASU4210102 \$27.50 ea.	2	Front - Rubber, extended progressive rate (60mm / Multi-fit).
<b>Strut Mount</b>	OASU0719001 \$80 ea.	2	Supplied with all required nuts, washers and bushes.

\* Ride heights approximate only, based on standard dual cab style-side ute with no additional load, unless otherwise stated.

\* Outback Armour recommend that a minimum of two thirds of the original suspension travel in each direction is retained for optimal performance and durability.

**RECOMMENDED RECOVERY GEAR**

<b>Snatch Strap</b>	OASS6T9M	1	Dynamic Snatch Strap - 6T/9M (2.00T - 3.00T)
<b>Recovery Kits</b>	OAQUICKSKST	1	Quick Snatch Kit - Small Truck
	OACOMPSKST	1	Comp Snatch Kit - Small Truck
	OAWINCHKIT	1	Winch Utility Kit

\*\* Complete range of Outback Armour recovery gear available at rear of this guide.

Notes:

**ISUZU MU-X**

9/2013 +

**SUSPENSION KITS - FRONT****PERFORMANCE**

v

**ADJ. INTERNAL BYPASS**

v

**Trail**

Lift front: 35mm (approx, height adjustable struts to 50mm)

Suits vehicles with oem bumper or light front loads

OASU911900T \$700 kit	OASU911900T-ADJ \$900 kit	
2x OASU0860007 (struts)	2x OASU0865007-ADJ (struts)	

\* kit prices include struts listed above plus the following parts \*

1x OASU1019001 (coil springs)

Coil spring seat spacers included with struts for height adjustment.

**Expedition & Expedition HD**

Lift front: 50mm (approx, height adjustable struts to 50mm)

Suits vehicles with a steel bullbar, winch or heavy front loads

OASU911900E \$700 kit	OASU911900E-ADJ \$900 kit	
2x OASU0860007 (struts)	2x OASU0865007-ADJ (struts)	

\* kit prices include struts listed above plus the following parts \*

1x OASU1015001 (coil springs)

Coil spring seat spacers included with struts for height adjustment.

**° Assembled Struts - Trail**

Lift front: 50mm (@ approx 0-50kg load)

Suits vehicles with oem bumper or light front loads

OASU931900T \$880 pr.	OASU931900T-ADJ \$1,080 pr.	
2x OASU391900T (each)	2x OASU391900T-ADJ (each)	

Assembled struts include: struts, coil springs &amp; top mounts.

**° Assembled Struts - Exped**

Lift front: 50mm (@ approx 50-100kg load)

Suits vehicles with a steel bullbar or medium front loads

OASU931900E \$880 pr.	OASU931900E-ADJ \$1,080 pr.	
2x OASU391900E (each)	2x OASU391900E-ADJ (each)	

Assembled struts include: struts, coil springs &amp; top mounts.

**° Assembled Struts - Exped HD**

Lift front: 50mm (@ approx 100-150kg load)

Suits vehicles with a steel bullbar &amp; winch or heavy front loads

OASU931900H \$880 pr.	OASU931900H-ADJ \$1,080 pr.	
2x OASU391900H (each)	2x OASU391900H-ADJ (each)	

Assembled struts include: struts, coil springs &amp; top mounts.

**RECOMMENDED OPTIONS & UPGRADES****Jounce Stop Kit - Front**OASU4210202  
\$55 kit

Parts included:

2x OASU4210102 (jounce stops)

Rubber, extended progressive rate (60mm / Multi-fit).

Highly recommended to be installed in all vehicles with bullbars.

Lift heights are approximate and may vary depending on vehicle or product tolerances and load distribution.

**ISUZU MU-X**

9/2013 +

**SUSPENSION KITS - REAR**

PERFORMANCE v	ADJ. INTERNAL BYPASS v	
------------------	---------------------------	--

**Trail** Lift rear: 35mm (approx unladen)  
Suits vehicles with light or occasional medium loads

OASU923301T \$610 kit	Not available for this vehicle	
2x OASU0160056 (shocks)		

\* kit prices include shock absorbers listed above plus the following parts \*

1x OASU1033002 (coil springs)

**Expedition** Lift rear: 35mm (@ approx 150kg load)  
Suits vehicles with constant medium or occasional heavy loads

OASU923301E \$610 kit	Not available for this vehicle	
2x OASU0160056 (shocks)		

\* kit prices include shock absorbers listed above plus the following parts \*

1x OASU1033004 (coil springs)

Lift heights are approximate and may vary depending on vehicle & product tolerances and load distribution.





# JEEP GRAND CHEROKEE WK2

2011 +



PRODUCT	PART NO.	QTY	DETAILS
<b>Struts</b> Max CWG: 530	OASU0860009 \$250 ea.	2	<b>Performance</b> - 60mm twin tube. Spacer ring adjustable height spring seat. Heavy duty forged strut fork. * Suits models where sway bar links to control arm only.
<b>Shock Absorbers</b>	OASU0160026 \$175 ea.	2	<b>Performance</b> - 60mm twin tube. <b>Non Nivomat.</b> * Shock does not fit with Nivomat suspension mounts. * Can use oem standard mounts to fit this shock absorber.
	OASU0160068 \$175 ea.	2	<b>Performance</b> - 60mm twin tube. <b>Nivomat.</b> * Shock fits with Nivomat suspension upper shock absorber mounts. * Must replace coil springs to maintain GVM and tow capacity.
<b>Coil Springs</b> (front, pair)	OASU1026003 \$260 pr.	1	Trail/Expedition - 30mm lift (approx unladen, height adj. struts) <i>For vehicles with added accessories, use the supplied spacer rings on struts to retain vehicle ride height.</i>
<b>Coil Springs</b> (rear, pair)	OASU1026004 \$325 pr.	1	Trail - 40mm lift (approx unladen)
	OASU1026006 \$325 pr.	1	Expedition - 40mm lift (@ approx 100kg load) <i>Note: heavier spring rate for towing applications.</i>
<b>Bump Stops</b>	OASU4226001 \$27.50 ea.	2	Front & Rear - Rubber, progressive rate (replaces OEM foam)

\* Ride heights approximates only, with no additional load, unless otherwise stated.

\* Outback Armour recommend that a minimum of two thirds of the original suspension travel in each direction is retained for optimal performance and durability.

## RECOMMENDED RECOVERY GEAR

<b>Snatch Strap</b>	OASS8T9M	1	Dynamic Snatch Strap - 8T/9M (2.66T - 4.00T)
<b>Recovery Kits</b>	OAQUICKSKLT	1	Quick Snatch Kit - Light Truck
	OACOMPSKLT	1	Comp Snatch Kit - Light Truck
	OAWINCHKIT	1	Winch Utility Kit

\*\* Complete range of Outback Armour recovery gear available at rear of this guide.

Notes:

# JEEP GRAND CHEROKEE WK2

2011 +



## SUSPENSION KITS - FRONT

PERFORMANCE v	ADJ. INTERNAL BYPASS v	
------------------	---------------------------	--

### Trail & Expedition

Lift front: 30mm (approx, height adjustable struts to 45mm)

OASU912600T \$760 kit	Not available for this vehicle	
2x OASU0860009 (struts)		

\* kit prices include struts listed above plus the following parts \*

1x OASU1026003 (coil springs)

\* Only suits models where sway bar links to control arm (not strut leg).

Lift heights are approximate and may vary depending on vehicle or product tolerances and load distribution.

**SUSPENSION KITS - REAR**

PERFORMANCE v	ADJ. INTERNAL BYPASS v	
------------------	---------------------------	--

**Trail - Non Nivomat** Lift rear: 40mm (approx unladen)  
Suits vehicles with light or occasional medium loads

OASU922600T <b>\$675 kit</b>	Not available for this vehicle	
2x OASU0160026 (shocks)		

\* kit prices include shock absorbers listed above plus the following parts \*

1x OASU1026004 (coil springs)

\* Shock does not fit with Nivomat suspension mounts. Can use oem standard mounts to fit this shock absorber.

**Expedition - Non Nivomat** Lift rear: 40mm (@ approx 100kg load, heavier spring rate for towing)  
Suits vehicles with constant medium or occasional heavy loads

OASU922600E <b>\$675 kit</b>	Not available for this vehicle	
2x OASU0160026 (shocks)		

\* kit prices include shock absorbers listed above plus the following parts \*

1x OASU1026006 (coil springs)

\* Shock does not fit with Nivomat suspension mounts. Can use oem standard mounts to fit this shock absorber.

**Trail - Nivomat** Lift rear: 40mm (approx unladen)  
Suits vehicles with light or occasional medium loads

OASU922601T <b>\$675 kit</b>	Not available for this vehicle	
2x OASU0160068 (shocks)		

\* kit prices include shock absorbers listed above plus the following parts \*

1x OASU1026004 (coil springs)

\* Shock fits with Nivomat suspension upper shock absorber mounts.

\* Must replace coil springs to maintain GVM and tow capacity.

**Expedition - Nivomat** Lift rear: 40mm (@ approx 100kg load, heavier spring rate for towing)  
Suits vehicles with constant medium or occasional heavy loads

OASU922601E <b>\$675 kit</b>	Not available for this vehicle	
2x OASU0160068 (shocks)		

\* kit prices include shock absorbers listed above plus the following parts \*

1x OASU1026006 (coil springs)

\* Shock fits with Nivomat suspension upper shock absorber mounts.

\* Must replace coil springs to maintain GVM and tow capacity.

Lift heights are approximate and may vary depending on vehicle & product tolerances and load distribution.



# JEEP WRANGLER TJ

1996 - 2006



PRODUCT	PART NO.	QTY	DETAILS
<b>Shock Absorbers</b> (front)	OASU0154013 \$175 ea.	2	<b>Performance</b> - 54mm twin tube. Complete set of rubber bushes & billet bar pins included. Steel shroud.
<b>Shock Absorbers</b> (rear)	OASU0154009 \$175 ea.	2	<b>Performance</b> - 54mm twin tube. Complete set of billet bar pins included. Steel shroud.
<b>Coil Springs</b> (front, pair)	OASU1023001 \$260 pr.	1	Trail - 50mm lift (approx unladen)
<b>Coil Springs</b> (rear, pair)	OASU1023002 \$260 pr.	1	Trail - 50mm lift (approx unladen)

## ACCESSORY ITEMS & CORRECTION COMPONENTS

<b>Coil Spring Spacers</b>	OASU2115201 \$35 ea.	2	Front - 15mm, polyurethane
	OASU2130202 \$45 ea.	2	Front - 30mm, polyurethane
	OASU2110203 \$45 ea.	2	Rear - 10mm, polyurethane
	OASU2130204 \$105 ea.	2	Rear - 30mm, polyurethane

\* Ride heights approximates only, with no additional load, unless otherwise stated.

\* Outback Armour recommend that a minimum of two thirds of the original suspension travel in each direction is retained for optimal performance and durability.

## RECOMMENDED RECOVERY GEAR

<b>Snatch Strap</b>	OASS6T9M	1	Dynamic Snatch Strap - 6T/9M (2.00T - 3.00T)
<b>Recovery Kits</b>	OAQUICKSKST	1	Quick Snatch Kit - Small Truck
	OACOMPSKST	1	Comp Snatch Kit - Small Truck
	OAWINCHKIT	1	Winch Utility Kit

\*\* Complete range of Outback Armour recovery gear available at rear of this guide.

Notes:



# JEEP WRANGLER TJ

1996 - 2006



## SUSPENSION KITS - FRONT

PERFORMANCE v	ADJ. INTERNAL BYPASS v	
------------------	---------------------------	--

Lift front: 50mm (approx unladen)

Suits vehicles with oem bumper or light front loads

### Trail

OASU912300T \$610 kit	Not available for this vehicle	
2x OASU0154013 (shocks)		

\* kit prices include shock absorbers listed above plus the following parts \*

1 pair OASU1023001 (coil springs)

## SUSPENSION KITS - REAR

PERFORMANCE v	ADJ. INTERNAL BYPASS v	
------------------	---------------------------	--

Lift rear: 50mm (approx unladen)

Suits vehicles with light or occasional medium loads

### Trail

OASU922300T \$610 kit	Not available for this vehicle	
2x OASU0154009 (shocks)		

\* kit prices include shock absorbers listed above plus the following parts \*

1 pair OASU1023002 (coil springs)

Lift heights are approximate and may vary depending on vehicle or product tolerances and load distribution.

**JEEP WRANGLER JK SWB**

2007 - 2018



PRODUCT	PART NO.	QTY	DETAILS
<b>Shock Absorbers</b> (front)	TBA	2	New designs pending.
<b>Shock Absorbers</b> (rear)	TBA	2	New designs pending.
<b>Steering Damper</b>	OASU0954006 \$150 ea.	1	51mm twin tube foam cell construction. Complete set of bushes included. Steel shroud.
<b>Coil Springs</b> (front, pair)	OASU1024001 \$260 pr.	1	Trail - 50mm lift (approx unladen)
<b>Coil Springs</b> (rear, pair)	OASU1024002 \$260 pr.	1	Trail - 50mm lift (approx unladen)

**ACCESSORY ITEMS & CORRECTION COMPONENTS**

<b>Coil Spring Spacers</b>	OASU2115201 \$35 ea.	2	Front - 15mm, polyurethane
	OASU2130202 \$45 ea.	2	Front - 30mm, polyurethane

\* Ride heights approximates only, with no additional load, unless otherwise stated.

\* Outback Armour recommend that a minimum of two thirds of the original suspension travel in each direction is retained for optimal performance and durability.

**RECOMMENDED RECOVERY GEAR**

<b>Snatch Strap</b>	OASS6T9M	1	Dynamic Snatch Strap - 6T/9M (2.00T - 3.00T)
<b>Recovery Kits</b>	OAQUICKSKST	1	Quick Snatch Kit - Small Truck
	OACOMPSKST	1	Comp Snatch Kit - Small Truck
	OAWINCHKIT	1	Winch Utility Kit

\*\* Complete range of Outback Armour recovery gear available at rear of this guide.

Notes:

**JEEP WRANGLER JK SWB**

2007 - 2018

**SUSPENSION KITS - FRONT**

<b>PERFORMANCE</b> v	<b>ADJ. INTERNAL BYPASS</b> v	
-------------------------	----------------------------------	--

**Trail Kit A** Lift front: 50mm (approx unladen)  
Suits vehicles with oem bumper or light front loads

Not available for this vehicle	Not available for this vehicle	
-----------------------------------	-----------------------------------	--

\* kit prices include shock absorbers listed above plus the following parts \*

1 pair OASU1024001 (coil springs)

**Trail Kit B** Lift front: 50mm (approx unladen)  
Suits vehicles with oem bumper or light front loads

Not available for this vehicle	Not available for this vehicle	
-----------------------------------	-----------------------------------	--

\* kit prices include shock absorbers listed above plus the following parts \*

1 pair OASU1024001 (coil springs)    1x OASU0954006 (steering damper)  
Includes: foam cell steering damper

**SUSPENSION KITS - REAR**

<b>PERFORMANCE</b> v	<b>ADJ. INTERNAL BYPASS</b> v	
-------------------------	----------------------------------	--

**Trail** Lift rear: 50mm (approx unladen)  
Suits vehicles with light or occasional medium loads

Not available for this vehicle	Not available for this vehicle	
-----------------------------------	-----------------------------------	--

\* kit prices include struts listed above plus the following parts \*

1 pair OASU1024002 (coil springs)

Lift heights are approximate and may vary depending on vehicle or product tolerances and load distribution.

**JEEP WRANGLER JK LWB**

2007 +



PRODUCT	PART NO.	QTY	DETAILS
<b>Shock Absorbers</b> (front)	TBA	2	New designs pending.
<b>Shock Absorbers</b> (rear)	TBA	2	New designs pending.
<b>Steering Damper</b>	OASU0954006 \$150 ea.	1	51mm twin tube foam cell construction. Complete set of bushes included. Steel shroud.
<b>Coil Springs</b> (front, pair)	OASU1025001 \$260 ea.	1	Trail - 50mm lift (approx unladen)
<b>Coil Springs</b> (rear, pair)	OASU1025002 \$260 ea.	1	Trail - 50mm lift (approx unladen)

**ACCESSORY ITEMS & CORRECTION COMPONENTS**

<b>Coil Spring Spacers</b>	OASU2115201 \$35 ea.	2	Front - 15mm, polyurethane
	OASU2130202 \$45 ea.	2	Front - 30mm, polyurethane

\* Ride heights approximates only, with no additional load, unless otherwise stated.

\* Outback Armour recommend that a minimum of two thirds of the original suspension travel in each direction is retained for optimal performance and durability.

**RECOMMENDED RECOVERY GEAR**

<b>Snatch Strap</b>	OASS6T9M	1	Dynamic Snatch Strap - 6T/9M (2.00T - 3.00T)
<b>Recovery Kits</b>	OAQUICKSKST	1	Quick Snatch Kit - Small Truck
	OACOMPSKST	1	Comp Snatch Kit - Small Truck
	OAWINCHKIT	1	Winch Utility Kit

\*\* Complete range of Outback Armour recovery gear available at rear of this guide.

Notes:

**JEEP WRANGLER JK LWB**

2007 - 2018

**SUSPENSION KITS - FRONT**

PERFORMANCE v	ADJ. INTERNAL BYPASS v	
------------------	---------------------------	--

**Trail Kit A** Lift front: 50mm (approx unladen)  
Suits vehicles with oem bumper or light front loads

Not available for this vehicle	Not available for this vehicle	
-----------------------------------	-----------------------------------	--

\* kit prices include shock absorbers listed above plus the following parts \*

1 pair OASU1025001 (coil springs)

**Trail Kit B** Lift front: 50mm (approx unladen)  
Suits vehicles with oem bumper or light front loads

Not available for this vehicle	Not available for this vehicle	
-----------------------------------	-----------------------------------	--

\* kit prices include shock absorbers listed above plus the following parts \*

1 pair OASU1025001 (coil springs)    1x OASU0954006 (steering damper)  
Includes: foam cell steering damper

**SUSPENSION KITS - REAR**

PERFORMANCE v	ADJ. INTERNAL BYPASS v	
------------------	---------------------------	--

**Trail** Lift rear: 50mm (approx unladen)  
Suits vehicles with light or occasional medium loads

OASU922500T \$610 kit	Not available for this vehicle	
2x OASU0154010 (shocks)		

\* kit prices include struts listed above plus the following parts \*

1 pair OASU1025002 (coil springs)

Lift heights are approximate and may vary depending on vehicle or product tolerances and load distribution.

**MAZDA BT-50**

10/2006 - 9/2011



PRODUCT	PART NO.	QTY	DETAILS
<b>Shock Absorbers</b> (front)	OASU0160008 \$175 ea.	2	<b>Performance</b> - 60mm twin tube. Complete set of rubber bushes, washers & dust boot included.
<b>Shock Absorbers</b> (rear)	OASU0160009 \$175 ea.	2	<b>Performance</b> - 60mm twin tube. Complete set of rubber bushes included. Steel shroud.
<b>Torsion Bars</b> (pair)	OASU1211150 \$295 pr.	1	Trail / Expedition <i>Increased rate, 1025mm length, 27mm diameter.</i>
<b>Leaf Springs</b>	OASU1149001 \$250 ea.	2	Trail - 35mm lift (approx unladen) <i>4 primary + 2 secondary</i>
	OASU1149002 \$275 ea.	2	Expedition - 35mm lift (@ approx 250kg load) <i>5 primary + 2 secondary</i>
<i>** Refer leaf spring graph following for approximate deflections under load.</i>			
<b>Leaf Spring Bush Kit</b>	OASU210020K \$135 kit	1	12 polyurethane bushes & 2 inner tubes
<b>U-bolts</b>	OASU2388003 \$15 ea.	4	Suits leaf springs: OASU1149001 <i>M14 x 88 ID (RND) x 185 L</i>
	OASU2388001 \$15 ea.	4	Suits leaf springs: OASU1149002 <i>M14 x 88 ID (RND) x 210 L</i>
<i>** All u-bolts hardened steel, rolled threads, deep nuts &amp; spring washers.</i>			
<b>Pins</b>	OASU2500042 \$20 ea.	2	Greasable, hardened steel
<b>Shackles</b>	OASU2400054 \$35 ea.	2	Greasable, hardened steel pins

**ACCESSORY ITEMS & CORRECTION COMPONENTS**

<b>Bump Stops</b>	OASU4248004 \$85 kit	1	Rear - Rubber, extended progressive rate (2x 110mm).
-------------------	-------------------------	---	--

\* Ride heights approximate only, based on standard dual cab style-side ute with no additional load, unless otherwise stated.

\* Outback Armour recommend that a minimum of two thirds of the original suspension travel in each direction is retained for optimal performance and durability.

**RECOMMENDED RECOVERY GEAR**

<b>Snatch Strap</b>	OASS6T9M	1	Dynamic Snatch Strap - 6T/9M (2.00T - 3.00T)
<b>Recovery Kits</b>	OAQUICKSKST	1	Quick Snatch Kit - Small Truck
	OACOMPSKST	1	Comp Snatch Kit - Small Truck
	OAWINCHKIT	1	Winch Utility Kit

\*\* Complete range of Outback Armour recovery gear available at rear of this guide.

Notes:

**SUSPENSION KITS - FRONT**

PERFORMANCE v	ADJ. INTERNAL BYPASS v	
------------------	---------------------------	--

**Trail** Lift front: OEM torsion bar (height adjustable)  
Suits vehicles with oem bumper or light front loads

OASU914900T \$350 kit	Not available for this vehicle	
2x OASU0160008 (shocks)		

**Expedition** Lift front: Torsion bar (height adjustable)  
Suits vehicles with a steel bullbar, winch or heavy front loads

OASU914900E \$645 kit	Not available for this vehicle	
2x OASU0160008 (shocks)		

\* kit prices include shock absorbers listed above plus the following parts \*

1 pair OASU1211150 (torsion bars)



**SUSPENSION KITS - REAR**

<b>PERFORMANCE</b> v	<b>ADJ. INTERNAL BYPASS</b> v	
-------------------------	----------------------------------	--

**Trail** Lift rear: 35mm (approx unladen)  
Suits vehicles with light or occasional medium loads

OASU924900T <b>\$1,155 kit</b>	Not available for this vehicle	
2x OASU0160009 (shocks)		

\* kit prices include shock absorbers listed above plus the following parts \*

4x OASU2388003 (u-bolts) 1x OASU210020K (bush kit)	2x OASU1149001 (leaf springs)	2x OASU2500042 (pins) 2x OASU2400054 (shackles)
---	-------------------------------	--

**Expedition** Lift rear: 35mm (@ approx 250kg load)  
Suits vehicles with constant medium or occasional heavy loads

OASU924900E <b>\$1,205 kit</b>	Not available for this vehicle	
2x OASU0160009 (shocks)		

\* kit prices include shock absorbers listed above plus the following parts \*

4x OASU2388001 (u-bolts) 1x OASU210020K (bush kit)	2x OASU1149002 (leaf springs)	2x OASU2500042 (pins) 2x OASU2400054 (shackles)
---	-------------------------------	--

**RECOMMENDED OPTIONS & UPGRADES**

<b>Jounce Stop Kit - Rear</b>	Parts included:
OASU4248004 <b>\$85 kit</b>	2x OASU4210104 (jounce stops) Rubber, extended progressive rate (110mm). Recommended to be installed in all vehicles with heavy rear loads.

Lift heights are approximate and may vary depending on vehicle & product tolerances and load distribution.

**Ford Ranger PJ-PK / Mazda BT-50 Leaf Spring Deflection**

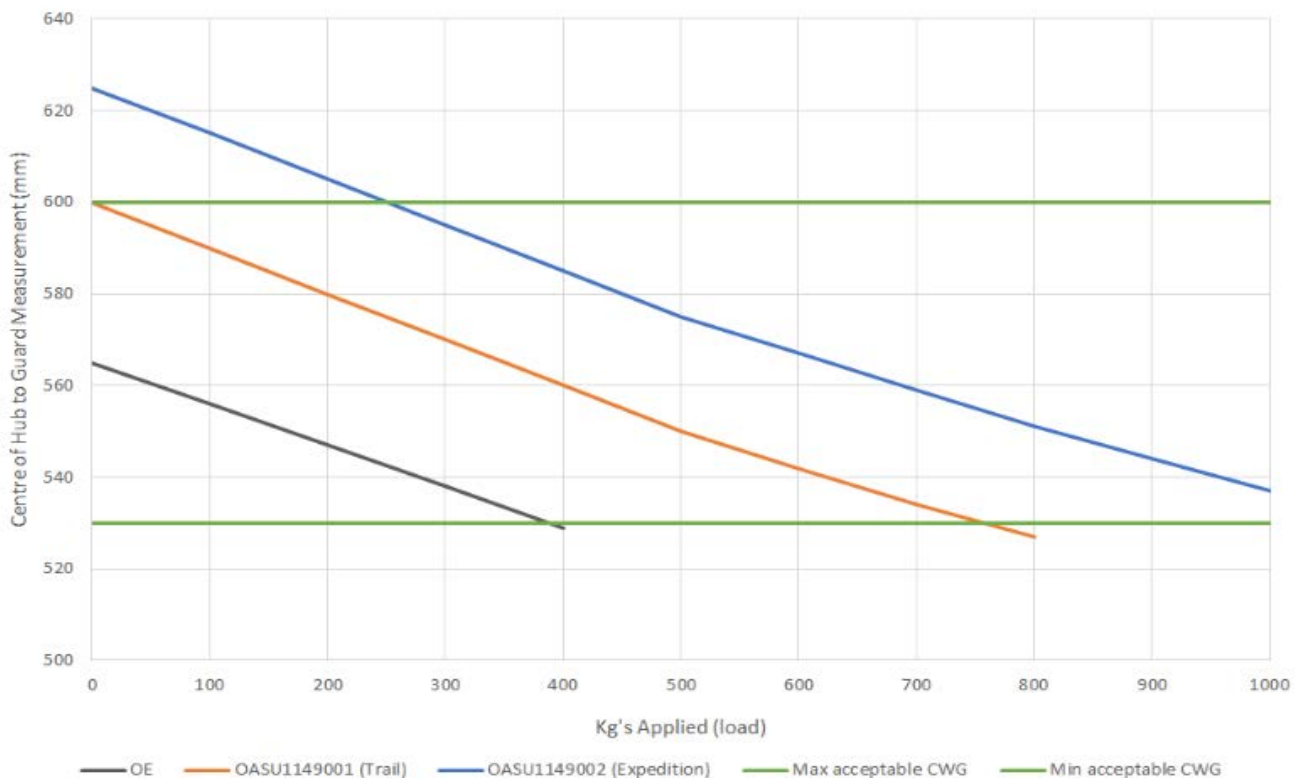



**MAZDA BT-50**

10/2011 +



PRODUCT	PART NO.	QTY	DETAILS
<b>Struts</b> Max CWG: 600	OASU0860005 \$220 ea.	2	<b>Performance</b> - 60mm twin tube. Spacer ring adjustable height spring seat. Complete set of rubber bushes, washers & dust boot included.
	OASU0865005-ADJ \$320 ea.	2	<b>Adjustable Internal Bypass</b> - 65mm twin tube. Threaded variable height spring seat. Complete set of rubber bushes, washers & dust boot included.
<b>Shock Absorbers</b>	OASU0160009L \$175 ea.	2	<b>Performance</b> - 60mm twin tube. Complete set of rubber bushes included. Steel shroud.
	OASU0165009L-ADJ \$220 ea.	2	<b>Adjustable Internal Bypass</b> - 65mm twin tube. Complete set of rubber bushes & dust boot included.
<b>Coil Springs</b> (pair)	OASU1048001 \$260 pr.	1	Trail - 35mm lift (approx unladen, height adj. struts to 50mm) <i>For vehicles with added accessories, use the supplied spacer rings on struts to retain vehicle ride height.</i>
	OASU1048003 \$260 pr.	1	Expedition - 50mm lift (approx unladen) <i>For vehicles with added accessories, use the supplied spacer rings on struts to retain vehicle ride height. Suits bullbar &amp; winch.</i>
<b>Leaf Springs</b>	OASU1148005 \$250 ea.	2	Trail - 40mm lift (approx unladen) <i>3 primary + 2 secondary</i>
	OASU1148001 \$250 ea.	2	Expedition - 40mm lift (@ approx 150kg load) <i>3 primary + 2 secondary</i>
	OASU1148002 \$300 ea.	2	Expedition HD - 40mm lift (@ approx 300kg load) <i>4 primary + 2 secondary</i>
	OASU1148003 \$340 ea.	2	Expedition XHD - 40mm lift (@ approx 500kg load) <i>5 primary + 2 secondary</i>
<i>** Refer leaf spring graph following for approximate deflections under load.</i>			
<b>Leaf Spring Bush Kit</b>	OASU210028K \$200 kit	1	12 polyurethane bushes & 2 inner tubes
<b>U-bolts</b>	OASU2388004 \$15 ea.	4	Suits leaf springs: OASU1148001 & OASU1148005 <i>M14 x 88 ID (RND) x 190 L</i>
	OASU2388002 \$15 ea.	4	Suits leaf springs: OASU1148002 & OASU1148003 <i>M14 x 88 ID (RND) x 215 L</i>
<i>** All u-bolts hardened steel, rolled threads, deep nuts &amp; spring washers.</i>			
<b>Pins</b>	OASU2500042 \$20 ea.	2	Greasable, hardened steel
<b>Shackles</b>	OASU2400060 \$35 ea.	2	Greasable, hardened steel pins
<b>ACCESSORY ITEMS &amp; CORRECTION COMPONENTS</b>			
<b>Centre Bearing Spacer Kit</b>	OASU3748001 \$45 kit	1	Supplied with all required washers and spacers. Recommended to improve tailshaft angle and reduce vibrations.
<b>Bump Stops</b>	OASU4210102 \$27.50 ea.	2	Front - Rubber, extended progressive rate (60mm / Multi-fit).
	OASU4248004 \$85 kit	1	Rear - Rubber, extended progressive rate (2x 110mm).
<b>Strut Mount</b>	OASU0750001 \$80 ea.	2	Supplied with all required nuts, washers and bushes.

\* Ride heights approximate only, based on standard dual cab style-side ute with no additional load, unless otherwise stated.

\* A minimum of two thirds of the original suspension travel in each direction is retained for optimal performance and durability.

**MAZDA BT-50**

10/2011 +

**SUSPENSION KITS - FRONT****PERFORMANCE**

v

**ADJ. INTERNAL BYPASS**

v

**Trail**

Lift front: 35mm (approx, height adjustable struts to 50mm)

Suits vehicles with oem bumper or light front loads

OASU914800T \$700 kit	OASU914800T-ADJ \$900 kit	
2x OASU0860005 (struts)	2x OASU0865005-ADJ (struts)	

\* kit prices include struts listed above plus the following parts \*

1x OASU1048001 (coil springs)

Coil spring seat spacers included with struts for height adjustment.

**Expedition & Expedition HD**

Lift front: 50mm (approx, height adjustable struts to 50mm)

Suits vehicles with a steel bullbar, winch or heavy front loads

OASU914800E \$700 kit	OASU914800E-ADJ \$900 kit	
2x OASU0860005 (struts)	2x OASU0865005-ADJ (struts)	

\* kit prices include struts listed above plus the following parts \*

1x OASU1048003 (coil springs)

Coil spring seat spacers included with struts for height adjustment.

**° Assembled Struts - Trail**

Lift front: 50mm (@ approx 0-50kg load)

Suits vehicles with oem bumper or light front accessories

OASU934800T \$880 pr.	OASU934800T-ADJ \$1,080 pr.	
2x OASU394800T (each)	2x OASU394800T-ADJ (each)	

Assembled struts include: struts, coil springs &amp; top mounts.

**° Assembled Struts - Exped**

Lift front: 50mm (@ approx 50-100kg load)

Suits vehicles with a steel bullbar or medium front loads

OASU934800E \$880 pr.	OASU934800E-ADJ \$1,080 pr.	
2x OASU394800E (each)	2x OASU394800E-ADJ (each)	

Assembled struts include: struts, coil springs &amp; top mounts.

**° Assembled Struts - Exped HD**

Lift front: 50mm (@ approx 100-150kg load)

Suits vehicles with a steel bullbar &amp; winch or heavy front loads

OASU934800H \$880 pr.	2x OASU934800H-ADJ \$1,080 pr.	
2x OASU394800H (each)	2x OASU394800H-ADJ (each)	

Assembled struts include: struts, coil springs &amp; top mounts.

**RECOMMENDED OPTIONS & UPGRADES****Jounce Stop Kit - Front**

OASU4210202

\$55 kit

Parts included:

2x OASU4210102 (jounce stops)

Rubber, extended progressive rate (60mm / Multi-fit).

Highly recommended to be installed in all vehicles with bullbars.

Lift heights are approximate and may vary depending on vehicle or product tolerances and load distribution.

**MAZDA BT-50**

10/2011 +

**SUSPENSION KITS - REAR****PERFORMANCE**

v

**ADJ. INTERNAL BYPASS**

v

Lift rear: 40mm (approx unladen)

Suits vehicles with light or occasional medium loads

**Trail**

OASU924800T \$1,265 kit	OASU924800T-ADJ \$1,355 kit	
2x OASU0160009L (shocks)	2x OASU0165009L-ADJ (shocks)	

\* kit prices include shock absorbers listed above plus the following parts \*

1x OASU210028K (bush kit)	1x OASU3748001 (c/b spacer kit)	2x OASU2500042 (pins)
4x OASU2388004 (u-bolts)	2x OASU1148005 (leaf springs)	2x OASU2400060 (shackles)

Rear bump stop kit "OASU4248004" highly recommended to reduce risk of component damage at full compression.

Lift rear: 40mm (@ approx 150kg load)

Suits vehicles with light or occasional medium loads

**Expedition**

OASU924800E \$1,265 kit	OASU924800E-ADJ \$1,355 kit	
2x OASU0160009L (shocks)	2x OASU0165009L-ADJ (shocks)	

\* kit prices include shock absorbers listed above plus the following parts \*

1x OASU210028K (bush kit)	1x OASU3748001 (c/b spacer kit)	2x OASU2500042 (pins)
4x OASU2388004 (u-bolts)	2x OASU1148001 (leaf springs)	2x OASU2400060 (shackles)

Rear bump stop kit "OASU4248004" highly recommended to reduce risk of component damage at full compression.

Lift rear: 40mm (@ approx 300kg load)

Suits vehicles with constant medium or occasional heavy loads

**Expedition HD**

OASU924800H \$1,365 kit	OASU924800H-ADJ \$1,455 kit	
2x OASU0160009L (shocks)	2x OASU0165009L-ADJ (shocks)	

\* kit prices include shock absorbers listed above plus the following parts \*

1x OASU210028K (bush kit)	1x OASU3748001 (c/b spacer kit)	2x OASU2500042 (pins)
4x OASU2388002 (u-bolts)	2x OASU1148002 (leaf springs)	2x OASU2400060 (shackles)

Rear bump stop kit "OASU4248004" highly recommended to reduce risk of component damage at full compression.

Lift rear: 40mm (@ approx 500kg load)

Suits vehicles with constant heavy loads

**Expedition XHD**

OASU924800X \$1,445 kit	OASU924800X-ADJ \$1,535 kit	
2x OASU0160009L (shocks)	2x OASU0165009L-ADJ (shocks)	

\* kit prices include shock absorbers listed above plus the following parts \*

1x OASU210028K (bush kit)	1x OASU3748001 (c/b spacer kit)	2x OASU2500042 (pins)
4x OASU2388002 (u-bolts)	2x OASU1148003 (leaf springs)	2x OASU2400060 (shackles)

Rear bump stop kit "OASU4248004" highly recommended to reduce risk of component damage at full compression.

**RECOMMENDED OPTIONS & UPGRADES**

<b>Jounce Stop Kit - Rear</b>	Parts included:
OASU4248004 \$85 kit	2x OASU4210104 (jounce stops) Rubber, extended progressive rate (110mm). Recommended to be installed in all vehicles with heavy rear loads.

Lift heights are approximate and may vary depending on vehicle &amp; product tolerances and load distribution.

**MAZDA BT-50**

10/2011 +



PRODUCT	PART NO.	DETAILS
Leaf Springs	OASU1148005	Trail - 40mm lift (approx unladen) <i>3 primary + 2 secondary</i>
	OASU1148001	Expedition - 40mm lift (@ approx 150kg load) <i>3 primary + 2 secondary</i>
	OASU1148002	Expedition HD - 40mm lift (@ approx 300kg load) <i>4 primary + 2 secondary</i>
	OASU1148003	Expedition XHD - 40mm lift (@ approx 500kg load) <i>5 primary + 2 secondary</i>

Ford Ranger PX-PXII / Mazda BT-50 Leaf Spring Deflection

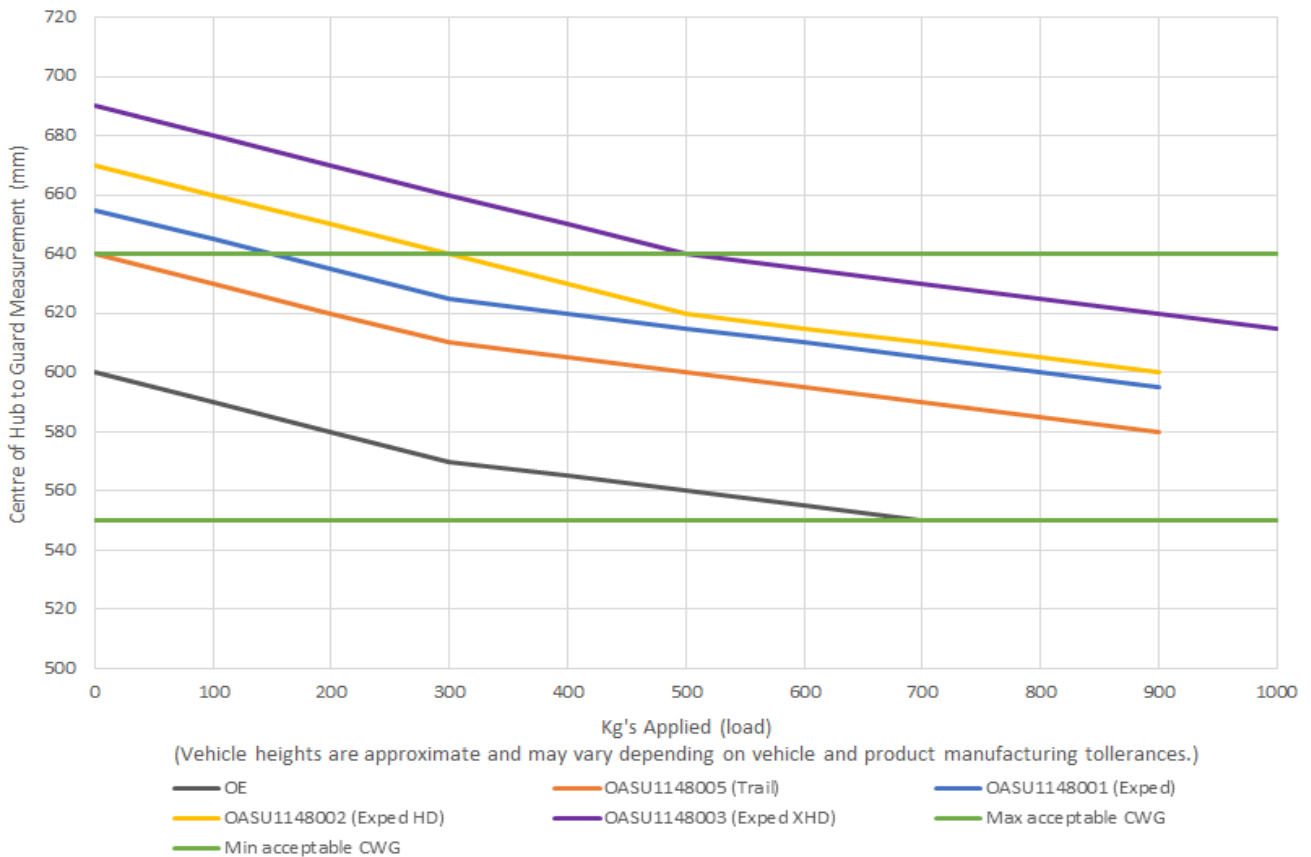

- \* CWG (Centre Wheel to Guard) measured from centre of wheel to under-side of guard.
- \* Max/Min Acceptable CWG are shown as a recommended guideline only.
- \* CWG Heights approximate only, based on a standard dual cab style-side ute with no additional load.

Notes:

# MERCEDES BENZ X-CLASS

2018 + (4WD Models)



PRODUCT	PART NO.	QTY	DETAILS
<b>Struts</b> Max CWG: 585	OASU0860088 \$220 ea.	2	<b>Performance</b> - 60mm twin tube. Spacer ring adjustable height spring seat. Complete set of rubber bushes, washers & dust boot included.
	OASU0865088-ADJ \$320 ea.	2	<b>Adjustable Internal Bypass</b> - 65mm twin tube. Threaded variable height spring seat. Complete set of rubber bushes, washers & dust boot included.
<b>Shock Absorbers</b>	OASU0160088 \$175 ea.	2	<b>Performance</b> - 60mm twin tube. Complete set of rubber bushes included. Steel shroud.
	OASU0160088-ADJ \$220 ea.	2	<b>Adjustable Internal Bypass</b> - 60mm twin tube. Complete set of rubber bushes & dust boot included.
<b>Coil Springs</b> (pair)	OASU1088001 \$260 ea.	1	Trail - 35mm lift (approx unladen, adj. struts to 40mm) <i>With 10mm spring seat spacer installed. Use the supplied spacer rings on struts for vehicles with added accessories.</i>
	OASU1088003 \$260 ea.	1	Exped / HD - 35mm lift (@ approx 100kg load, adj. struts) <i>With 15mm spring seat spacer installed. Heavier spring rate than OASU1088001. Suits vehicles with heavy bullbar &amp; winch combinations.</i>
<b>Coil Springs</b> (rear pair)	OASU1088002 \$260 pr.	1	Trail - 35mm lift (approx unladen)
	OASU1088004 \$325 pr.	1	Expedition - 35mm lift (@ approx 150kg load)
	OASU1088006 \$350 pr.	1	Expedition HD - 35mm lift (@ approx 300kg load)
<i>** Refer coil spring graph following for approximate deflections under load.</i>			

## ACCESSORY ITEMS & CORRECTION COMPONENTS

<b>Bump Stops</b>	OASU4230004 \$95 kit.	1	Rear - Rubber, extended progressive rate (2x 110mm).
<b>Headlight Adjustment Bracket</b>	OASU3730002 \$30 ea.	1	Bracket required to adjust headlight angle on lifted vehicles with HID headlights.
<b>Sway Bar Relocation Kit</b>	OASU3730004 \$30 ea.	1	Relocates the sway bar mounting point to original position. Must have on all lifted vehicles.
<b>Strut Mount</b>	OASU0740001 \$80 ea.	2	Supplied with all required nuts, washers and bushes.

\* Ride heights approximate only, based on standard dual cab style-side ute with no additional load, unless otherwise stated.

\* Outback Armour recommend that a minimum of two thirds of the original suspension travel in each direction is retained for optimal performance and durability.

## RECOMMENDED RECOVERY GEAR

<b>Snatch Strap</b>	OASS6T9M	1	Dynamic Snatch Strap - 6T/9M (2.00T - 3.00T)
<b>Recovery Kits</b>	OAQUICKSKST	1	Quick Snatch Kit - Small Truck
	OACOMPSKST	1	Comp Snatch Kit - Small Truck
	OAWINCHKIT	1	Winch Utility Kit

\*\* Complete range of Outback Armour recovery gear available at rear of this guide.

Notes:



# MERCEDES BENZ X-CLASS

2018 + (4WD Models)



## SUSPENSION KITS - FRONT

**PERFORMANCE**

v

**ADJ. INTERNAL BYPASS**

v

### Trail

Lift front: 35mm (approx, height adjustable struts to 40mm)

Suits vehicles with oem bumper or bullbar

OASU918800T \$700 kit	OASU918800T-ADJ \$900 kit	
2x OASU0860088 (struts)	2x OASU0865088-ADJ (struts)	

\* kit prices include struts listed above plus the following parts \*

1x OASU1088001 (coil springs)

With 10mm spring seat spacer installed. Coil spring seat spacers included with struts for height adjustment.

### Expedition

Lift front: 35mm (@ approx 100kg load, height adjustable struts to 40mm)

Suits vehicles with bullbar & winch.

OASU918800H \$700 kit	OASU918800H-ADJ \$900 kit	
2x OASU0860088 (struts)	2x OASU0865088-ADJ (struts)	

\* kit prices include struts listed above plus the following parts \*

1x OASU1088003 (coil springs)

With 15mm spring seat spacer installed. Coil spring seat spacers included with struts for height adjustment.

### ° Assembled Struts - Trail

Lift front: 35mm (@ approx 0-50kg load)

Suits vehicles with oem bumper or light front loads

OASU938800T \$880 pr.	OASU938800T-ADJ \$1,080 pr.	
2x OASU398800T (each)	2x OASU398800T-ADJ (each)	

Assembled struts include: struts, coil springs & top mounts.

### ° Assembled Struts - Exped

Lift front: 35mm (@ approx 50-100kg load)

Suits vehicles with a steel bullbar or medium front loads

OASU938800E \$880 pr.	OASU938800E-ADJ \$1,080 pr.	
2x OASU398800E (each)	2x OASU398800E-ADJ (each)	

Assembled struts include: struts, coil springs & top mounts.

### ° Assembled Struts - Exped HD

Lift front: 35mm (@ approx 100-150kg load)

Suits vehicles with a steel bullbar & winch or heavy front loads

OASU938800H \$880 pr.	OASU938800H-ADJ \$1,080 pr.	
2x OASU398800H (each)	2x OASU398800H-ADJ (each)	

Assembled struts include: struts, coil springs & top mounts.

Lift heights are approximate and may vary depending on vehicle or product tolerances and load distribution.

# MERCEDES BENZ X-CLASS

2018 + (4WD Models)



## SUSPENSION KITS - REAR

PERFORMANCE v	ADJ. INTERNAL BYPASS v	
------------------	---------------------------	--

### Trail

Lift rear: 35mm (approx unladen)

Suits vehicles with light or occasional medium loads

OASU928800T <b>\$670 kit</b>	OASU928800T-ADJ <b>\$760 kit</b>	
2x OASU0160088 (shocks)	2x OASU0160088-ADJ (shocks)	

\* kit prices include shock absorbers listed above plus the following parts \*

1x OASU3730002 (HID adjust.)      1 pair OASU1088002 (coil springs)      1x OASU3730004 (sway bar reloc.)

Rear bump stop kit "OASU4230004" highly recommended to reduce risk of component damage at full compression.  
HID headlight adjustment bracket and sway bar relocation kits included.

### Expedition

Lift rear: 35mm (@ approx 150kg load)

Suits vehicles with constant medium or occasional heavy loads

OASU928800E <b>\$735 kit</b>	OASU928800E-ADJ <b>\$825 kit</b>	
2x OASU0160088 (shocks)	2x OASU0160088-ADJ (shocks)	

\* kit prices include shock absorbers listed above plus the following parts \*

1x OASU3730002 (HID adjust.)      1 pair OASU1088004 (coil springs)      1x OASU3730004 (sway bar reloc.)

Rear bump stop kit "OASU4230004" highly recommended to reduce risk of component damage at full compression.  
HID headlight adjustment bracket and sway bar relocation kits included.

### Expedition HD

Lift rear: 35mm (@ approx 300kg load)

Suits vehicles with constant heavy loads

OASU928800H <b>\$760 kit</b>	OASU928800H-ADJ <b>\$825 kit</b>	
2x OASU0160088 (shocks)	2x OASU0160088-ADJ (shocks)	

\* kit prices include shock absorbers listed above plus the following parts \*

1x OASU3730002 (HID adjust.)      1 pair OASU1088006 (coil springs)      1x OASU3730004 (sway bar reloc.)

Rear bump stop kit "OASU4230004" highly recommended to reduce risk of component damage at full compression.  
HID headlight adjustment bracket and sway bar relocation kits included.

## RECOMMENDED OPTIONS & UPGRADES

<b>Jounce Stop Kit - Rear</b>  OASU4230004 <b>\$110 kit</b>	Parts included: 2x OASU4210104 (jounce stops)             2x OASU4210105 (stud kit) Rubber, extended progressive rate (110mm). Recommended to be installed in all vehicles with heavy rear loads.
--	--

Lift heights are approximate and may vary depending on vehicle & product tolerances and load distribution.

# MERCEDES BENZ X-CLASS

2018 + (4WD Models)



PRODUCT	PART NO.	DETAILS
Coil Springs	OASU1088002	Trail - 35mm lift (approx unladen) <i>progressive rate coil</i>
	OASU1088004	Expedition - 35mm lift (@ approx 150kg) <i>progressive rate coil</i>
	OASU1088006	Expedition HD - 35mm lift (@ approx 300kg load) <i>progressive rate coil</i>

Mercedes Benz X-Class Coil Spring Deflection

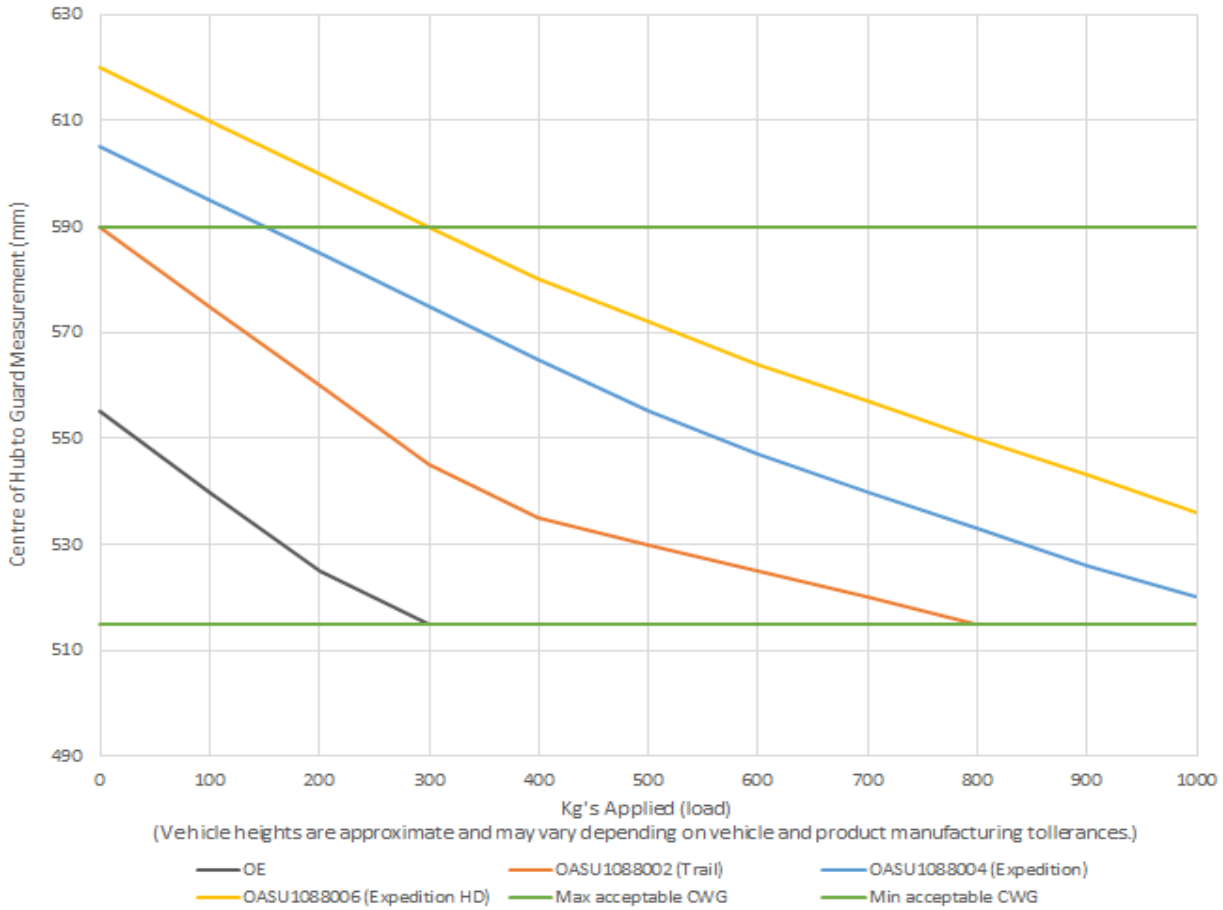

\* CWG (Centre Wheel to Guard) measured from centre of wheel to under-side of guard.

\* Max/Min Acceptable CWG are shown as a recommended guideline only.

\* CWG Heights approximate only, based on a standard dual cab style-side ute with no additional load.

Notes:

PRODUCT	PART NO.	QTY	DETAILS
<b>Struts</b> Max CWG: 570 (F) Max CWG: 595 (NF)	OASU0854010 \$220 ea.	2	<b>Performance</b> - 54mm twin tube. Spacer ring adjustable height spring seat. Complete set of rubber bushes, washers & dust boot included.
	OASU0850010-ADJ \$250 ea.	2	<b>Adjustable Internal Bypass</b> - 50mm twin tube. Threaded variable height spring seat. Complete set of rubber bushes, washers & dust boot included.
<b>Shock Absorbers</b>	OASU0154001 \$175 ea.	2	<b>Performance</b> - 54mm twin tube. Complete set of rubber bushes & dust boot included.
	OASU0150001-ADJ \$200 ea.	2	<b>Adjustable Internal Bypass</b> - 50mm twin tube. Complete set of rubber bushes & dust boot included.
<b>Coil Springs</b> (pair)	OASU1047001 \$260 pr.	1	Trail/Exped - 35mm lift (approx unladen, adj. struts to 50mm) <i>For vehicles with added accessories, use the supplied spacer rings on struts to retain vehicle ride height.</i>
<b>Leaf Springs</b>	OASU1147001 \$250 ea.	2	Trail - 40mm lift (approx unladen) <i>4 primary + 2 secondary</i>
	OASU1147002 \$270 ea.	2	Expedition - 40mm lift (@ approx 250kg load) <i>4 primary + 2 secondary</i>
	OASU1147003 \$290 ea.	2	Expedition - 40mm lift (@ approx 500kg load) <i>4 primary + 2 secondary</i>
<i>** Refer leaf spring graph following for approximate deflections under load.</i>			
<b>Leaf Spring Bush Kit</b>	OASU210022K \$135 kit	1	12 polyurethane bushes & 2 inner tubes
<b>U-bolts</b>	OASU2372001 \$15 ea.	4	Suits leaf springs: OASU1147001, OASU1147002 & OASU1147003 <i>M12 x 72 ID (SQR) x 175 L</i>
	<i>** All u-bolts hardened steel, rolled threads, deep nuts &amp; spring washers.</i>		
<b>Pins</b>	OASU2500042 \$20 ea.	2	Greasable, hardened steel
<b>Shackles</b>	OASU2400055 \$35 ea.	2	Greasable, hardened steel pins

**ACCESSORY ITEMS & CORRECTION COMPONENTS**

<b>Bump Stops</b>	OASU4247001 \$88 ea.	1	Shortened upper bump stops. Allows additional control arm droop for suspension travel.
	OASU4210004 \$165 kit	1	Rear - Rubber, extended progressive rate (110mm).
<b>Strut Mount</b>	OASU0747004 \$80 ea.	2	Supplied with all required nuts, washers and bushes.
<b>Tailshaft Spacer</b>	OASU3747001 \$140 ea.	1	13.25mm spacer. Suits 2 piece tailshafts only.

\* Ride heights approximate only, based on standard dual cab style-side ute with OE overfender flares and no additional load, unless otherwise stated.

\* Outback Armour recommend that a minimum of two thirds of the original suspension travel in each direction is retained for optimal performance and durability.

\* When raising Triton models with a 2 piece tailshaft, a tailshaft spacer should be installed between the diff flange and tailshaft flange to re-centralise and reduce the thrust load of the centre bearing. This may not reduce any vibration issues.

\* Leaf Spring Wedges may assist in reducing tailshaft vibration which is an issue common to this vehicle when raised.

\* *If tailshaft vibrations persist, modifying the two-piece assembly to a single piece tailshaft is an effective solution.*

**SUSPENSION KITS - FRONT**

<b>PERFORMANCE</b> v	<b>ADJ. INTERNAL BYPASS</b> v	
-------------------------	----------------------------------	--

Lift front: 35mm (approx, height adjustable struts to 50mm)  
Suits vehicles with oem bumper, bullbar or winch

**Trail & Expedition**

OASU914700T <b>\$700 kit</b>	OASU914700T-ADJ <b>\$760 kit</b>	
2x OASU0854010 (struts)	2x OASU0850010-ADJ (struts)	

\* kit prices include struts listed above plus the following parts \*

1x OASU1047001 (coil springs)

Coil spring seat spacers included with struts for height adjustment.  
Bump Stop Upper kit highly recommended for improved suspension travel.

Lift front: 50mm (@ approx 0-50kg load)

Suits vehicles with oem bumper or light front loads

**° Assembled Struts - Trail**

OASU934700T <b>\$880 pr.</b>	OASU934700T-ADJ <b>\$940 pr.</b>	
2x OASU394700T (each)	2x OASU394700T-ADJ (each)	

Assembled struts include: struts, coil springs & top mounts.  
Bump Stop Upper kit highly recommended for improved suspension travel.

Lift front: 50mm (@ approx 50-100kg load)

Suits vehicles with a steel bullbar or medium front loads

**° Assembled Struts - Exped**

OASU934700E <b>\$880 pr.</b>	OASU934700E-ADJ <b>\$940 pr.</b>	
2x OASU394700E (each)	2x OASU394700E-ADJ (each)	

Assembled struts include: struts, coil springs & top mounts.  
Bump Stop Upper kit highly recommended for improved suspension travel.

Lift front: 50mm (@ approx 100-150kg load)

Suits vehicles with a steel bullbar & winch or heavy front loads

**° Assembled Struts - Exped HD**

OASU934700H <b>\$880 pr.</b>	OASU934700H-ADJ <b>\$940 pr.</b>	
2x OASU394700H (each)	2x OASU394700H-ADJ (each)	

Assembled struts include: struts, coil springs & top mounts.  
Bump Stop Upper kit highly recommended for improved suspension travel.

**RECOMMENDED OPTIONS & UPGRADES**

<p><b>Jounce Stop Kit - Front</b></p> <p>OASU4247001 <b>\$88 kit</b></p>	<p>Parts included:</p> <p>2x polyurethane bump stops</p> <p>Shortened upper bump stops. Allows additional control arm droop for suspension travel.</p>
--	--

Lift heights are approximate and may vary depending on vehicle or product tolerances and load distribution.

**SUSPENSION KITS - REAR**

PERFORMANCE v	ADJ. INTERNAL BYPASS v	
------------------	---------------------------	--

**Trail** Lift rear: 40mm (approx unladen)  
Suits vehicles with light or occasional medium loads

OASU924700T <b>\$1,155 kit</b>	OASU924700T-ADJ <b>\$1,205 kit</b>	
2x OASU0154001 (shocks)	2x OASU0150001-ADJ (shocks)	

\* kit prices include shock absorbers listed above plus the following parts \*

- |                           |                               |                           |
|---------------------------|-------------------------------|---------------------------|
| 1x OASU210022K (bush kit) | 2x OASU1147001 (leaf springs) | 2x OASU2500042 (pins)     |
| 4x OASU2372001 (u-bolts)  |                               | 2x OASU2400055 (shackles) |

Rear bump stop kit "OASU4210004" highly recommended to reduce risk of component damage at full compression.

**Expedition** Lift rear: 40mm (@ approx 250kg load)  
Suits vehicles with constant medium or occasional heavy loads

OASU924700E <b>\$1,195 kit</b>	OASU924700E-ADJ <b>\$1,245 kit</b>	
2x OASU0154001 (shocks)	2x OASU0150001-ADJ (shocks)	

\* kit prices include shock absorbers listed above plus the following parts \*

- |                           |                               |                           |
|---------------------------|-------------------------------|---------------------------|
| 1x OASU210022K (bush kit) | 2x OASU1147002 (leaf springs) | 2x OASU2500042 (pins)     |
| 4x OASU2372001 (u-bolts)  |                               | 2x OASU2400055 (shackles) |

Rear bump stop kit "OASU4210004" highly recommended to reduce risk of component damage at full compression.

**Expedition HD** Lift rear : 40mm (@ approx 500kg load)  
Suits vehicles with constant heavy loads

OASU924700H <b>\$1,235 kit</b>	OASU924700H-ADJ <b>\$1,285 kit</b>	
2x OASU0154001 (shocks)	2x OASU0150001-ADJ (shocks)	

\* kit prices include shock absorbers listed above plus the following parts \*

- |                           |                               |                           |
|---------------------------|-------------------------------|---------------------------|
| 1x OASU210022K (bush kit) | 2x OASU1147003 (leaf springs) | 2x OASU2500042 (pins)     |
| 4x OASU2372001 (u-bolts)  |                               | 2x OASU2400055 (shackles) |

Rear bump stop kit "OASU4210004" highly recommended to reduce risk of component damage at full compression.

**RECOMMENDED OPTIONS & UPGRADES**

<b>Jounce Stop Kit - Rear</b>  OASU4210004 <b>\$165 kit</b>	Parts included: 2x OASU4210104 (jounce stops)      2x OASU4210103 (u-bolt plate) Rubber, extended progressive rate (110mm). Recommended to be installed in all vehicles with heavy rear loads.
--	---

Lift heights are approximate and may vary depending on vehicle & product tolerances and load distribution.

PRODUCT	PART NO.	DETAILS
Leaf Springs	OASU1147001	Lift: 40mm rear (approx unladen) 4 primary + 2 secondary
	OASU1147002	Lift: 40mm rear (@ approx 250kg load) 4 primary + 2 secondary
	OASU1147003	Lift: 40mm rear (@ approx 500kg load) 4 primary + 2 secondary

Mitsubishi Triton ML/MN Leaf Spring Deflection (Factory flared models)

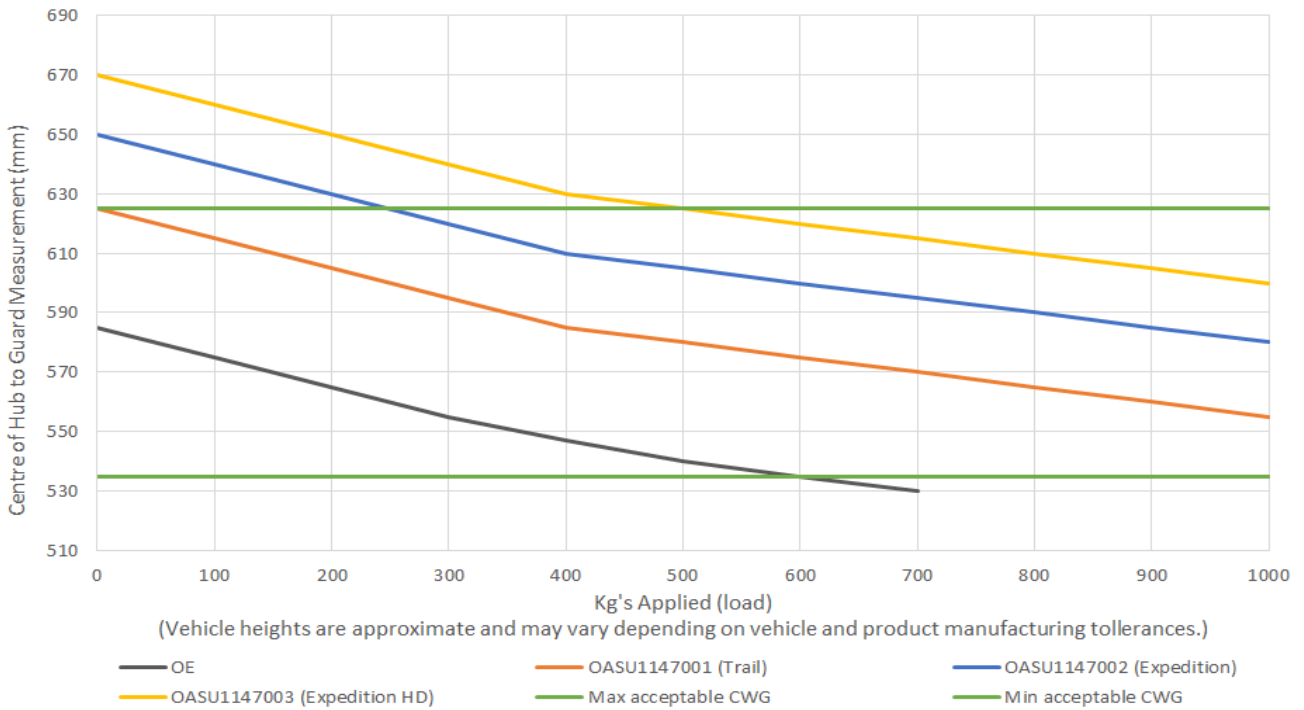

\* CWG (Centre Wheel to Guard) measured from centre of wheel to under-side of guard.

\* Max/Min Acceptable CWG are shown as a recommended guideline only.

\* CWG Heights approximate only, based on a standard dual cab style-side ute with no additional load.

Notes:



**MITSUBISHI TRITON MQ**

2015 +



PRODUCT	PART NO.	QTY	DETAILS
<b>Struts</b> Max CWG: 570 (F) Max CWG: 595 (NF)	OASU0854010 \$220 ea.	2	<b>Performance</b> - 54mm twin tube. Spacer ring adjustable height spring seat. Complete set of rubber bushes, washers & dust boot included.
	OASU0850010-ADJ \$250 ea.	2	<b>Adjustable Internal Bypass</b> - 50mm twin tube. Threaded variable height spring seat. Complete set of rubber bushes, washers & dust boot included.
<b>Shock Absorbers</b>	OASU0160025 \$175 ea.	2	<b>Performance</b> - 60mm twin tube. Complete set of rubber bushes & dust boot included.
	OASU0165025-ADJ \$220 ea.	2	<b>Adjustable Internal Bypass</b> - 65mm twin tube. Adjustable internal bypass. Complete set of rubber bushes included. Synthetic dust boot.
<b>Coil Springs</b> (pair)	OASU1047001 \$260 pr.	1	Trail/Exped - 30mm lift (approx unladen, adj. struts to 40mm) <i>For vehicles with added accessories, use the supplied spacer rings on struts to retain vehicle ride height.</i>
<b>Leaf Springs</b>	OASU1157001 \$250 ea.	2	Trail - 40mm lift (approx unladen) <i>4 primary + 2 secondary</i>
	OASU1157002 \$275 ea.	2	Expedition - 40mm lift (@ approx 200kg load) <i>5 primary + 2 secondary</i>
	OASU1157003 \$295 ea.	2	Expedition HD - 40mm lift (@ approx 400kg load) <i>5 primary + 2 secondary</i>
<i>** Refer leaf spring graph following for approximate deflections under load.</i>			
<b>Leaf Spring Bush Kit</b>	OASU210033K \$145 kit	1	12 polyurethane bushes & 2 inner tubes
<b>U-bolts</b>	OASU2362001 \$15 ea.	4	Suits leaf springs: OASU1157001, OASU1157002 & OASU1157003 <i>M14 x 62 ID (SQR) x 185 L</i>
	<i>** All u-bolts hardened steel, rolled threads, deep nuts &amp; spring washers.</i>		
<b>Pins</b>	OASU2500042 \$20 ea.	2	Greasable, hardened steel
<b>Shackles</b>	OASU2400063 \$35 ea.	2	Greasable, hardened steel pins

**ACCESSORY ITEMS & CORRECTION COMPONENTS**

<b>Bump Stops</b>	OASU4247001 \$88 ea.	1	Shortened upper bump stops. Allows additional control arm droop for suspension travel.
	OASU4210004 \$165 kit	1	Rear - Rubber, extended progressive rate (2x 110mm).
<b>Strut Mount</b>	OASU0747004 \$80 ea.	2	Supplied with all required nuts, washers and bushes.
<b>Tailshaft Spacer</b>	OASU3747001 \$140 ea.	1	13.25mm spacer. Suits 2 piece tailshafts only.

\* Ride heights approximate only, based on standard dual cab style-side ute with OE overfender flares and no additional load, unless otherwise stated.

\* Outback Armour recommend that a minimum of two thirds of the original suspension travel in each direction is retained for optimal performance and durability.

\* When raising Triton models with a 2 piece tailshaft, a tailshaft spacer should be installed between the diff flange and tailshaft flange to re-centralise and reduce the thrust load of the centre bearing. This may not reduce any vibration issues.

\* Leaf Spring Wedges may assist in reducing tailshaft vibration which is an issue common to this vehicle when raised.

\* If tailshaft vibrations persist, modifying the two-piece assembly to a single piece tailshaft is an effective solution.

**SUSPENSION KITS - FRONT**

<b>PERFORMANCE</b> v	<b>ADJ. INTERNAL BYPASS</b> v	
-------------------------	----------------------------------	--

Lift front: 30mm (approx, height adjustable struts to 40mm)  
Suits vehicles with oem bumper, bullbar or winch

**Trail & Expedition**

OASU915700T \$700 kit	OASU915700T-ADJ \$760 kit	
2x OASU0854010 (struts)	2x OASU0850010-ADJ (struts)	

\* kit prices include struts listed above plus the following parts \*

1x OASU1047001 (coil springs)

Coil spring seat spacers included with struts for height adjustment.  
Bump Stop Upper kit highly recommended for improved suspension travel.

Lift front: 40mm (@ approx 0-50kg load)

Suits vehicles with oem bumper or light front loads

**° Assembled Struts - Trail**

OASU935700T \$880 pr.	OASU935700T-ADJ \$940 pr.	
2x OASU395700T (each)	2x OASU395700T-ADJ (each)	

Assembled struts include: struts, coil springs & top mounts.  
Bump Stop Upper kit highly recommended for improved suspension travel.

Lift front: 40mm (@ approx 50-100kg load)

Suits vehicles with a steel bullbar or medium front loads

**° Assembled Struts - Exped**

OASU935700E \$880 pr.	OASU935700E-ADJ \$940 pr.	
2x OASU395700E (each)	2x OASU395700E-ADJ (each)	

Assembled struts include: struts, coil springs & top mounts.  
Bump Stop Upper kit highly recommended for improved suspension travel.

Lift front: 40mm (@ approx 100-150kg load)

Suits vehicles with a steel bullbar & winch or heavy front loads

**° Assembled Struts - Exped HD**

OASU935700H \$880 pr.	OASU935700H-ADJ \$940 pr.	
2x OASU395700H (each)	2x OASU395700H-ADJ (each)	

Assembled struts include: struts, coil springs & top mounts.  
Bump Stop Upper kit highly recommended for improved suspension travel.

**RECOMMENDED OPTIONS & UPGRADES**

<p><b>Jounce Stop Kit - Front</b></p> <p>OASU4247001 \$88 kit</p>	<p>Parts included:</p> <p>2x polyurethane bump stops)</p> <p>Shortened upper bump stops. Allows additional control arm droop for suspension travel.</p>
---	---

Lift heights are approximate and may vary depending on vehicle or product tolerances and load distribution.

**SUSPENSION KITS - REAR**

PERFORMANCE v	ADJ. INTERNAL BYPASS v	
------------------	---------------------------	--

**Trail** Lift rear: 40mm (approx unladen)  
Suits vehicles with light or occasional medium loads

OASU925700T <b>\$1,165 kit</b>	OASU925700T-ADJ <b>\$1,255 kit</b>	
2x OASU0160025 (shocks)	2x OASU0165025-ADJ (shocks)	

\* kit prices include shock absorbers listed above plus the following parts \*

- |                           |                               |                           |
|---------------------------|-------------------------------|---------------------------|
| 1x OASU210033K (bush kit) | 2x OASU1157001 (leaf springs) | 2x OASU2500042 (pins)     |
| 4x OASU2362001 (u-bolts)  |                               | 2x OASU2400063 (shackles) |

Rear bump stop kit "OASU4210004" highly recommended to reduce risk of component damage at full compression.

**Expedition** Lift rear: 40mm (@ approx 200kg load)  
Suits vehicles with constant medium or occasional heavy loads

OASU925700E <b>\$1,215 kit</b>	OASU925700E-ADJ <b>\$1,305 kit</b>	
2x OASU0160025 (shocks)	2x OASU0165025-ADJ (shocks)	

\* kit prices include shock absorbers listed above plus the following parts \*

- |                           |                               |                           |
|---------------------------|-------------------------------|---------------------------|
| 1x OASU210033K (bush kit) | 2x OASU1157002 (leaf springs) | 2x OASU2500042 (pins)     |
| 4x OASU2362001 (u-bolts)  |                               | 2x OASU2400063 (shackles) |

Rear bump stop kit "OASU4210004" highly recommended to reduce risk of component damage at full compression.

**Expedition HD** Lift rear: 40mm (@ approx 400kg load)  
Suits vehicles with constant heavy loads

OASU925700H <b>\$1,345 kit</b>	OASU925700H-ADJ <b>\$1,435 kit</b>	
2x OASU0160025 (shocks)	2x OASU0165025-ADJ (shocks)	

\* kit prices include shock absorbers listed above plus the following parts \*

- |                           |                               |                           |
|---------------------------|-------------------------------|---------------------------|
| 1x OASU210033K (bush kit) | 2x OASU1157003 (leaf springs) | 2x OASU2500042 (pins)     |
| 4x OASU2362001 (u-bolts)  |                               | 2x OASU2400063 (shackles) |

Rear bump stop kit "OASU4210004" highly recommended to reduce risk of component damage at full compression.

**RECOMMENDED OPTIONS & UPGRADES**

<b>Jounce Stop Kit - Rear</b>	Parts included:	
OASU4210004 <b>\$165 kit</b>	2x OASU4210104 (jounce stops)	2x OASU4210103 (u-bolt plate)
	Rubber, extended progressive rate (110mm).	
	Recommended to be installed in all vehicles with heavy rear loads.	

Lift heights are approximate and may vary depending on vehicle & product tolerances and load distribution.

# MITSUBISHI TRITON MQ

2015 +



PRODUCT	PART NO.	DETAILS
Leaf Springs	OASU1157001	Lift: 40mm rear (approx unladen) 4 primary + 2 secondary
	OASU1157002	Lift: 40mm rear (@ approx 200kg load) 4 primary + 2 secondary
	OASU1157003	Lift: 40mm rear (@ approx 400kg load) 5 primary + 2 secondary

Mitsubishi Triton MQ Leaf Spring Deflection

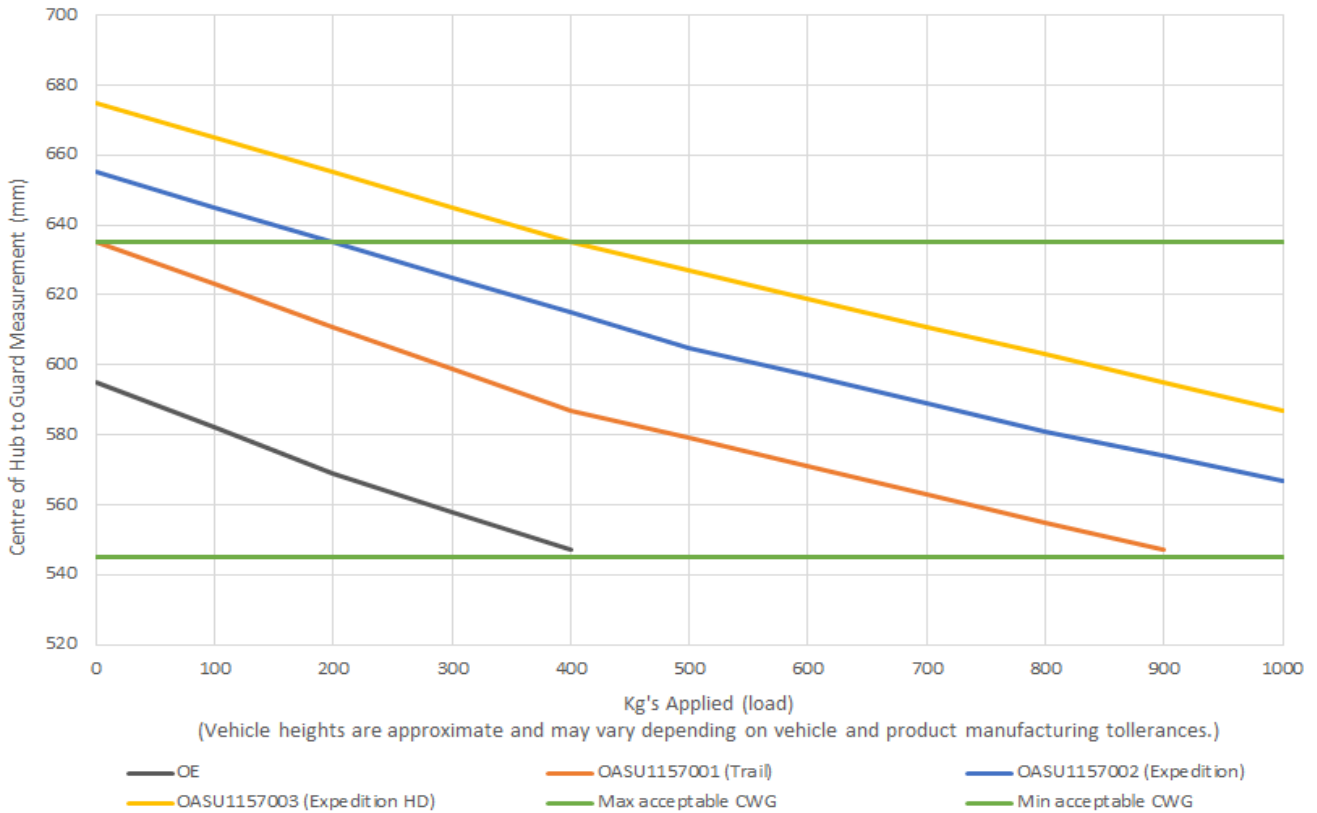

\* CWG (Centre Wheel to Guard) measured from centre of wheel to under-side of guard.

\* Max/Min Acceptable CWG are shown as a recommended guideline only.

\* CWG Heights approximate only, based on a standard dual cab style-side ute with no additional load.

Notes:

# MITSUBISHI CHALLENGER PB/PC

2008 - 2016



PRODUCT	PART NO.	QTY	DETAILS
<b>Struts</b> Max CWG: 570 (F) Max CWG: 595 (NF)	OASU0854010 \$220 ea.	2	<b>Performance</b> - 54mm twin tube. Spacer ring adjustable height spring seat. Complete set of rubber bushes, washers & dust boot included.
	OASU0850010-ADJ \$250 ea.	2	<b>Adjustable Internal Bypass</b> - 50mm twin tube. Threaded variable height spring seat. Complete set of rubber bushes, washers & dust boot included.
<b>Shock Absorbers</b>	OASU0154018 \$175 ea.	2	<b>Performance</b> - 54mm twin tube. Complete set of rubber bushes & dust boot included.
<b>Coil Springs</b> (front pair)	OASU1047001 \$260 pr.	1	Trail/Exped - 35mm lift (approx unladen, adj. struts to 50mm) <i>For vehicles with added accessories, use the supplied spacer rings on struts to retain vehicle ride height.</i>
<b>Coil Springs</b> (rear pair)	OASU1047002 \$260 pr.	1	Trail - 35mm lift (approx unladen)
	OASU1047004 \$260 pr.	1	Expedition - 35mm lift (@ approx 100kg load)

## ACCESSORY ITEMS & CORRECTION COMPONENTS

<b>Bump Stops</b>	OASU4247001 \$88 ea.	1	Shortened upper bump stops. Allows additional control arm droop for suspension travel.
<b>Strut Mount</b>	OASU0747004 \$80 ea.	2	Supplied with all required nuts, washers and bushes.

\* Ride heights approximate only, based on standard dual cab style-side ute with no additional load, unless otherwise stated.

\* Outback Armour recommend that a minimum of two thirds of the original suspension travel in each direction is retained for optimal performance and durability.

## RECOMMENDED RECOVERY GEAR

<b>Snatch Strap</b>	OASS6T9M	1	Dynamic Snatch Strap - 6T/9M (2.00T - 3.00T)
<b>Recovery Kits</b>	OAQUICKSKST	1	Quick Snatch Kit - Small Truck
	OACOMPSKST	1	Comp Snatch Kit - Small Truck
	OAWINCHKIT	1	Winch Utility Kit

\*\* Complete range of Outback Armour recovery gear available at rear of this guide.

# MITSUBISHI CHALLENGER PB/PC

2008 - 2016



## SUSPENSION KITS - FRONT

PERFORMANCE v	ADJ. INTERNAL BYPASS v	
------------------	---------------------------	--

Lift front: 35mm (approx, height adjustable struts to 50mm)  
Suits vehicles with oem bumper, bullbar or winch

### Trail & Expedition

OASU914700T \$700 kit	OASU914700T-ADJ \$760 kit	
2x OASU0854010 (struts)	2x OASU0850010-ADJ (struts)	

\* kit prices include struts listed above plus the following parts \*

1x OASU1047001 (coil springs)

Coil spring seat spacers included with struts for height adjustment.  
Bump Stop Upper kit highly recommended for improved suspension travel.

Lift front: 50mm (@ approx 0-50kg load)

Suits vehicles with oem bumper or light front loads

### ° Assembled Struts - Trail

OASU934700T \$880 pr.	OASU934700T-ADJ \$940 pr.	
2x OASU394700T (each)	2x OASU394700T-ADJ (each)	

Assembled struts include: struts, coil springs & top mounts.  
Bump Stop Upper kit highly recommended for improved suspension travel.

Lift front: 50mm (@ approx 50-100kg load)

Suits vehicles with a steel bullbar or medium front loads

### ° Assembled Struts - Exped

OASU934700E \$880 pr.	OASU934700E-ADJ \$940 pr.	
2x OASU394700E (each)	2x OASU394700E-ADJ (each)	

Assembled struts include: struts, coil springs & top mounts.  
Bump Stop Upper kit highly recommended for improved suspension travel.

Lift front: 50mm (@ approx 100-150kg load)

Suits vehicles with a steel bullbar & winch or heavy front loads

### ° Assembled Struts - Exped HD

OASU934700H \$880 pr.	OASU934700H-ADJ \$940 pr.	
2x OASU394700H (each)	2x OASU394700H-ADJ (each)	

Assembled struts include: struts, coil springs & top mounts.  
Bump Stop Upper kit highly recommended for improved suspension travel.

Lift heights are approximate and may vary depending on vehicle or product tolerances and load distribution.

**MITSUBISHI CHALLENGER PB/PC**

2008 - 2016

**SUSPENSION KITS - REAR**

PERFORMANCE v	ADJ. INTERNAL BYPASS v	
------------------	---------------------------	--

**Trail** Lift rear: 35mm (approx unladen)  
Suits vehicles with light or occasional medium loads

OASU924701T \$610 kit	Not available for this vehicle	
2x OASU0154018 (shocks)		

\* kit prices include shock absorbers listed above plus the following parts \*

1x OASU1047002 (coil springs)

**Expedition** Lift rear: 35mm (@ approx 100kg load)  
Suits vehicles with constant medium or occasional heavy loads

OASU924701E \$610 kit	Not available for this vehicle	
2x OASU0154018 (shocks)		

\* kit prices include shock absorbers listed above plus the following parts \*

1x OASU1047004 (coil springs)

Lift heights are approximate and may vary depending on vehicle & product tolerances and load distribution.





## MITSUBISHI PAJERO NM-NX (PETROL)

1999 - 2016



PRODUCT	PART NO.	QTY	DETAILS
<b>Struts</b> Max CWG: 540	OASU0854005 \$220 ea.	2	<b>Performance</b> - 54mm twin tube. Spacer ring adjustable height spring seat. Complete set of rubber bushes, washers & dust boot included.
<b>Shock Absorbers</b>	OASU0154006 \$175 ea.	2	<b>Performance</b> - 54mm twin tube. Complete set of rubber bushes & dust boot included.
<b>Coil Springs</b> (front pair)	OASU1098001 \$260 pr.	1	Trail - 35mm lift (unladen, height adj. struts to 50mm) <i>Suits petrol models. For vehicles with added accessories, use the supplied spacer rings on struts to retain vehicle ride height.</i>
<b>Coil Springs</b> (rear pair)	OASU1098002 \$275 pr.	1	Trail - 50mm lift (approx unladen)
	OASU1098004 \$290 pr.	1	Expedition - 50mm lift (@ approx 150kg load)

### ACCESSORY ITEMS & CORRECTION COMPONENTS

<b>Strut Mount</b>	OASU0798001 \$80 ea.	2	Supplied with all required nuts, washers and bushes.
--------------------	-------------------------	---	--

\* Ride heights approximate only, based on standard dual cab style-side ute with no additional load, unless otherwise stated.

\* Outback Armour recommend that a minimum of two thirds of the original suspension travel in each direction is retained for optimal performance and durability.

### RECOMMENDED RECOVERY GEAR

<b>Snatch Strap</b>	OASS6T9M	1	Dynamic Snatch Strap - 6T/9M (2.00T - 3.00T)
<b>Recovery Kits</b>	OAQUICKSKST	1	Quick Snatch Kit - Small Truck
	OACOMPSKST	1	Comp Snatch Kit - Small Truck
	OAWINCHKIT	1	Winch Utility Kit

\*\* Complete range of Outback Armour recovery gear available at rear of this guide.

**MITSUBISHI PAJERO NM-NX (PETROL)**

1999 - 2016

**SUSPENSION KITS - FRONT (PETROL)**

PERFORMANCE v	ADJ. INTERNAL BYPASS v	
------------------	---------------------------	--

Lift front: 35mm (approx, height adjustable struts to 50mm)  
Suits vehicles with oem bumper, bullbar or winch

**Trail (Petrol)**

OASU919800T \$700 kit	Not available for this vehicle	
2x OASU0854005 (struts)		

\* kit prices include struts listed above plus the following parts \*

1x OASU1098001 (coil springs)

Coil spring seat spacers included with struts for height adjustment.

Lift front: 35mm (@ approx 0-50kg load)

**° Assembled Struts - Trail**

Suits vehicles with oem bumper or light front loads

OASU939800T \$880 pr.	Not available for this vehicle	
2x OASU399800T (each)		

Assembled struts include: struts, coil springs & top mounts.

Lift front: 35mm (@ approx 50-100kg load)

**° Assembled Struts - Exped**

Suits vehicles with a steel bullbar or medium front loads

OASU939800E \$880 pr.	Not available for this vehicle	
2x OASU39800E (each)		

Assembled struts include: struts, coil springs & top mounts.

Lift front: 35mm (@ approx 100-150kg load)

**° Assembled Struts - Exped HD**

Suits vehicles with a steel bullbar & winch or heavy front loads

OASU939800H \$880 pr.	Not available for this vehicle	
2x OASU39800H (each)		

Assembled struts include: struts, coil springs & top mounts.

Lift heights are approximate and may vary depending on vehicle or product tolerances and load distribution.

**MITSUBISHI PAJERO NM-NX (PETROL)**

1999 - 2016

**SUSPENSION KITS - REAR****PERFORMANCE**

v

**ADJ. INTERNAL BYPASS**

v

Lift rear: 50mm (approx unladen)

Suits vehicles with light or occasional medium loads

**Trail**

OASU929800T

\$625 kit

Not available for  
this vehicle

2x OASU0154006 (shocks)

\* kit prices include shock absorbers listed above plus the following parts \*

1x OASU1098002 (coil springs)

Lift rear: 50mm (@ approx 150kg load)

Suits vehicles with constant medium or occasional heavy loads

**Expedition**

OASU929800E

\$640 kit

Not available for  
this vehicle

2x OASU0154006 (shocks)

\* kit prices include shock absorbers listed above plus the following parts \*

1x OASU1098004 (coil springs)

Lift heights are approximate and may vary depending on vehicle &amp; product tolerances and load distribution.



# MITSUBISHI PAJERO NM-NX (DIESEL)

1999 - 2016



PRODUCT	PART NO.	QTY	DETAILS
<b>Struts</b> Max CWG: 540	OASU0854005 \$220 ea.	2	<b>Performance</b> - 54mm twin tube. Spacer ring adjustable height spring seat. Complete set of rubber bushes, washers & dust boot included.
<b>Shock Absorbers</b>	OASU0154006 \$175 ea.	2	<b>Performance</b> - 54mm twin tube. Complete set of rubber bushes & dust boot included.
<b>Coil Springs</b> (front pair)	OASU1098003 \$260 pr.	1	Trail - 35mm lift (unladen, height adj. struts to 50mm) <b>Suits diesel models.</b> For vehicles with added accessories, use the supplied spacer rings on struts to retain vehicle ride height.
<b>Coil Springs</b> (rear pair)	OASU1098002 \$275 pr.	1	Trail - 50mm lift (approx unladen)
	OASU1098004 \$290 pr.	1	Expedition - 50mm lift (@ approx 150kg load)

## ACCESSORY ITEMS & CORRECTION COMPONENTS

<b>Strut Mount</b>	OASU0798001 \$80 ea.	2	Supplied with all required nuts, washers and bushes.
--------------------	-------------------------	---	--

\* Ride heights approximate only, based on standard dual cab style-side ute with no additional load, unless otherwise stated.

\* Outback Armour recommend that a minimum of two thirds of the original suspension travel in each direction is retained for optimal performance and durability.

## RECOMMENDED RECOVERY GEAR

<b>Snatch Strap</b>	OASS6T9M	1	Dynamic Snatch Strap - 6T/9M (2.00T - 3.00T)
<b>Recovery Kits</b>	OAQUICKSKST	1	Quick Snatch Kit - Small Truck
	OACOMPSKST	1	Comp Snatch Kit - Small Truck
	OAWINCHKIT	1	Winch Utility Kit

\*\* Complete range of Outback Armour recovery gear available at rear of this guide.

# MITSUBISHI PAJERO NM-NX (DIESEL)

1999 - 2016



## SUSPENSION KITS - FRONT (DIESEL)

PERFORMANCE v	ADJ. INTERNAL BYPASS v	
------------------	---------------------------	--

Lift front: 35mm (approx, height adjustable struts to 50mm)  
Suits vehicles with oem bumper or bullbar

### Trail (Diesel)

OASU919801T \$700 kit	Not available for this vehicle	
2x OASU0854005 (struts)		

\* kit prices include struts listed above plus the following parts \*

1x OASU1098003 (coil springs)

Coil spring seat spacers included with struts for height adjustment.

Lift front: 35mm (@ approx 0-50kg load)

### ° Assembled Struts - Trail

Suits vehicles with oem bumper or light front loads

OASU939801T \$880 pr.	Not available for this vehicle	
2x OASU39801T (each)		

Assembled struts include: struts, coil springs & top mounts.

Lift front: 35mm (@ approx 50-100kg load)

### ° Assembled Struts - Exped

Suits vehicles with a steel bullbar or medium front loads

OASU939801E \$880 pr.	Not available for this vehicle	
2x OASU39801E (each)		

Assembled struts include: struts, coil springs & top mounts.

Lift front: 35mm (@ approx 100-150kg load)

### ° Assembled Struts - Exped HD

Suits vehicles with a steel bullbar & winch or very heavy front loads

OASU939801H \$880 pr.	Not available for this vehicle	
2x OASU39801H (each)		

Assembled struts include: struts, coil springs & top mounts.

Lift heights are approximate and may vary depending on vehicle or product tolerances and load distribution.

**MITSUBISHI PAJERO NM-NX (DIESEL)**

1999 - 2016

**SUSPENSION KITS - REAR****PERFORMANCE**

v

**ADJ. INTERNAL BYPASS**

v

Lift rear: 50mm (approx unladen)

Suits vehicles with light or occasional medium loads

**Trail**

OASU929800T

\$625 kit

Not available for  
this vehicle

2x OASU0154006 (shocks)

\* kit prices include shock absorbers listed above plus the following parts \*

1x OASU1098002 (coil springs)

Lift rear: 50mm (@ approx 150kg load)

Suits vehicles with constant medium or occasional heavy loads

**Expedition**

OASU929800E

\$640 kit

Not available for  
this vehicle

2x OASU0154006 (shocks)

\* kit prices include shock absorbers listed above plus the following parts \*

1x OASU1098004 (coil springs)

Lift heights are approximate and may vary depending on vehicle &amp; product tolerances and load distribution.





# MITSUBISHI PAJERO SPORT

2015 +



PRODUCT	PART NO.	QTY	DETAILS
<b>Struts</b> Max CWG: 555	OASU0854010 \$220 ea.	2	<b>Performance</b> - 54mm twin tube. Spacer ring adjustable height spring seat. Complete set of rubber bushes, washers & dust boot included.
	OASU0850010-ADJ \$250 ea.	2	<b>Adjustable Internal Bypass</b> - 50mm twin tube. Threaded variable height spring seat. Complete set of rubber bushes, washers & dust boot included.
<b>Shock Absorbers</b>	OASU0154018 \$175 ea.	2	<b>Performance</b> - 54mm twin tube. Complete set of rubber bushes & dust boot included.
<b>Coil Springs</b> (front pair)	OASU1047001 \$260 pr.	1	Trail/Exped - 35mm lift (approx unladen, adj. struts to 50mm) <i>For vehicles with added accessories, use the supplied spacer rings on struts to retain vehicle ride height.</i>
<b>Coil Springs</b> (rear pair)	OASU1047002 \$260 pr.	1	Trail - 35mm lift (approx unladen)
	OASU1047004 \$260 pr.	1	Expedition - 35mm lift (@ approx 100kg load)

## ACCESSORY ITEMS & CORRECTION COMPONENTS

<b>Bump Stops</b>	OASU4247001 \$88 ea.	1	Shortened upper bump stops. Allows additional control arm droop for suspension travel.
<b>Strut Mount</b>	OASU0747004 \$80 ea.	2	Supplied with all required nuts, washers and bushes.

\* Ride heights approximate only, based on standard dual cab style-side ute with no additional load, unless otherwise stated.

\* Outback Armour recommend that a minimum of two thirds of the original suspension travel in each direction is retained for optimal performance and durability.

## RECOMMENDED RECOVERY GEAR

<b>Snatch Strap</b>	OASS6T9M	1	Dynamic Snatch Strap - 6T/9M (2.00T - 3.00T)
<b>Recovery Kits</b>	OAQUICKSKST	1	Quick Snatch Kit - Small Truck
	OACOMPSKST	1	Comp Snatch Kit - Small Truck
	OAWINCHKIT	1	Winch Utility Kit

\*\* Complete range of Outback Armour recovery gear available at rear of this guide.

# MITSUBISHI PAJERO SPORT

2015 +



## SUSPENSION KITS - FRONT

PERFORMANCE v	ADJ. INTERNAL BYPASS v	
------------------	---------------------------	--

Lift front: 35mm (approx, height adjustable struts to 50mm)  
Suits vehicles with oem bumper, bullbar or winch

### Trail & Expedition

OASU915700T \$700 kit	OASU915700T-ADJ \$760 kit	
2x OASU0854010 (struts)	2x OASU0850010-ADJ (struts)	

\* kit prices include struts listed above plus the following parts \*

1x OASU1047001 (coil springs)

Coil spring seat spacers included with struts for height adjustment.  
Bump Stop Upper kit highly recommended for improved suspension travel.

Lift front: 50mm (@ approx 0-50kg load)

Suits vehicles with oem bumper or light front loads

### ° Assembled Struts - Trail

OASU935700T \$880 pr.	OASU935700T-ADJ \$940 pr.	
2x OASU395700T (each)	2x OASU395700T-ADJ (each)	

Assembled struts include: struts, coil springs & top mounts.  
Bump Stop Upper kit highly recommended for improved suspension travel.

Lift front: 50mm (@ approx 50-100kg load)

Suits vehicles with a steel bullbar or medium front loads

### ° Assembled Struts - Exped

OASU935700E \$880 pr.	OASU935700E-ADJ \$940 pr.	
2x OASU395700E (each)	2x OASU395700E-ADJ (each)	

Assembled struts include: struts, coil springs & top mounts.  
Bump Stop Upper kit highly recommended for improved suspension travel.

Lift front: 50mm (@ approx 100-150kg load)

Suits vehicles with a steel bullbar & winch or heavy front loads

### ° Assembled Struts - Exped HD

OASU935700H \$880 pr.	OASU935700H-ADJ \$940 pr.	
2x OASU395700H (each)	2x OASU395700H-ADJ (each)	

Assembled struts include: struts, coil springs & top mounts.  
Bump Stop Upper kit highly recommended for improved suspension travel.

Lift heights are approximate and may vary depending on vehicle or product tolerances and load distribution.

**MITSUBISHI PAJERO SPORT**

2015 +

**SUSPENSION KITS - REAR**

PERFORMANCE v	ADJ. INTERNAL BYPASS v	
------------------	---------------------------	--

**Trail** Lift rear: 35mm (approx unladen)  
Suits vehicles with light or occasional medium loads

OASU924701T \$610 kit	Not available for this vehicle	
2x OASU0154018 (shocks)		

\* kit prices include shock absorbers listed above plus the following parts \*  
1x OASU1047002 (coil springs)

**Expedition** Lift rear: 35mm (@ approx 100kg load)  
Suits vehicles with constant medium or occasional heavy loads

OASU924701E \$610 kit	Not available for this vehicle	
2x OASU0154018 (shocks)		

\* kit prices include shock absorbers listed above plus the following parts \*  
1x OASU1047004 (coil springs)

Lift heights are approximate and may vary depending on vehicle & product tolerances and load distribution.



# NISSAN NAVARA D22

1997 +



PRODUCT	PART NO.	QTY	DETAILS
<b>Shock Absorbers</b> (front) Max CWG: 525	OASU0154017 \$175 ea.	2	<b>Performance</b> - 54mm twin tube. Upper control arms must be modified or upgraded to provide adequate clearance with this shock absorber.
<b>Shock Absorbers</b> (rear)	OASU0154001 \$175 ea.	2	<b>Performance</b> - 54mm twin tube. Complete set of rubber bushes included. Steel shroud.
	OASU0150001-ADJ \$200 ea.	2	<b>Adjustable Internal Bypass</b> - 50mm twin tube. Complete set of rubber bushes & dust boot included.
<b>Torsion Bars</b> (pair)	OASU1211156 \$295 pr.	1	Trail / Expedition Increased rate, 892mm length, 27mm diameter.
<b>Leaf Springs</b>	OASU1122001 \$220 ea.	2	Trail - 40mm lift (approx unladen) 3 primary + 2 secondary
	OASU1122002 \$240 ea.	2	Expedition - 40mm lift (@ approx 200kg load) 4 primary + 2 secondary
<i>** Refer leaf spring graph following for approximate deflections under load.</i>			
<b>Leaf Spring Bush Kit</b>	OASU210029K \$110 kit	1	12 polyurethane bushes & 2 inner tubes
<b>U-bolts</b>	OASU2362003 \$15 ea.	4	Suits leaf springs: OASU1122001 & OASU1122002 M12 x 63 ID (SQR) x 185 L
	<i>** All u-bolts hardened steel, rolled threads, deep nuts &amp; spring washers.</i>		
<b>Pins</b>	OASU2500044 \$25 ea.	2	Greasable, hardened steel
<b>Shackles</b>	OASU2400061 \$35 ea.	2	Greasable, hardened steel pins

\* Ride heights approximate only, based on standard dual cab style-side ute with no additional load, unless otherwise stated.

\* Outback Armour recommend that a minimum of two thirds of the original suspension travel in each direction is retained for optimal performance and durability.

## RECOMMENDED RECOVERY GEAR

<b>Snatch Strap</b>	OASS6T9M	1	Dynamic Snatch Strap - 6T/9M (2.00T - 3.00T)
<b>Recovery Kits</b>	OAQUICKSKST	1	Quick Snatch Kit - Small Truck
	OACOMPSKST	1	Comp Snatch Kit - Small Truck
	OAWINCHKIT	1	Winch Utility Kit

*\*\* Complete range of Outback Armour recovery gear available at rear of this guide.*

Notes:

**NISSAN NAVARA D22**

1997 +

**SUSPENSION KITS - FRONT**

PERFORMANCE v	ADJ. INTERNAL BYPASS v	
------------------	---------------------------	--

**Trail**

Lift front: OEM torsion bar (height adjustable)  
'Suits vehicles with oem bumper or light front loads

OASU912200T \$350 kit	Not available for this vehicle	
2x OASU0154017 (shocks)		

Upper control arms must be modified or upgraded to provide adequate clearance between the control arm and the shock absorber body. Check for clearance before and after wheel alignment.

**Expedition & Expedition HD**

Lift front: Torsion bar (height adjustable)  
Suits vehicles with a steel bullbar, winch or heavy front loads

OASU912200E \$645 kit	Not available for this vehicle	
2x OASU0154017 (shocks)		

\* kit prices include shock absorbers listed above plus the following parts \*

1 pair OASU1211156 (torsion bars)

Upper control arms must be modified or upgraded to provide adequate clearance between the control arm and the shock absorber body. Check for clearance before and after wheel alignment.

Lift heights are approximate and may vary depending on vehicle or product tolerances and load distribution.

**NISSAN NAVARA D22**

1997 +

**SUSPENSION KITS - REAR****PERFORMANCE**  
v**ADJ. INTERNAL BYPASS**  
v**Trail**Lift rear: 40mm (approx unladen)  
Suits vehicles with light or occasional medium loads

OASU922200T <b>\$1,080 kit</b>	OASU922200T-ADJ <b>\$1,130 kit</b>	
2x OASU0154001 (shocks)	2x OASU0150001-ADJ (shocks)	
* kit prices include shock absorbers listed above plus the following parts *		
1x OASU210029K (bush kit) 4x OASU2362003 (u-bolts)	2x OASU1122001 (leaf springs)	2x OASU2500044 (pins) 2x OASU2400061 (shackles)

**Expedition**Lift rear: 40mm (@ approx 200kg load)  
Suits vehicles with constant medium or occasional heavy loads

OASU922200E <b>\$1,120 kit</b>	OASU922200E-ADJ <b>\$1,170 kit</b>	
2x OASU0154001 (shocks)	2x OASU0150001-ADJ (shocks)	
* kit prices include shock absorbers listed above plus the following parts *		
1x OASU210029K (bush kit) 4x OASU2362003 (u-bolts)	2x OASU1122002 (leaf springs)	2x OASU2500044 (pins) 2x OASU2400061 (shackles)

Lift heights are approximate and may vary depending on vehicle &amp; product tolerances and load distribution.



# NISSAN NAVARA D22

1997 +



PRODUCT	PART NO.	DETAILS
Leaf Springs	OASU1122001	Trail - 40mm lift (approx unladen) 3 primary + 2 secondary
	OASU1122002	Expedition - 40mm lift (@ approx 200kg) 4 primary + 2 secondary

Nissan Navara D22 Leaf Spring Deflection

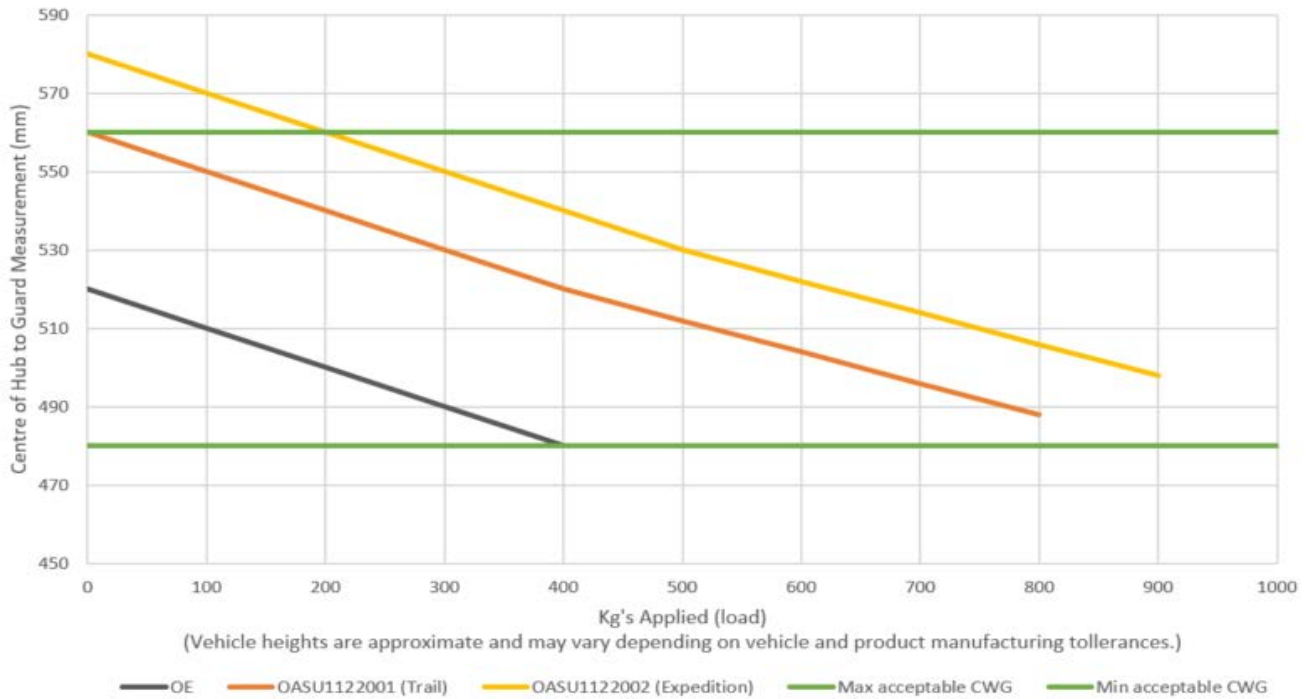

\* CWG (Centre Wheel to Guard) measured from centre of wheel to under-side of guard.

\* Max/Min Acceptable CWG are shown as a recommended guideline only.

\* CWG Heights approximate only, based on a standard dual cab style-side ute with no additional load.

Notes:

# NISSAN NAVARA D40 (4CYL & V6 PETROL)

2005 - 2016



PRODUCT	PART NO.	QTY	DETAILS
<b>Struts</b> Max CWG: 560	OASU0860006 \$220 ea.	2	<b>Performance</b> - 60mm twin tube. Spacer ring adjustable height spring seat. Complete set of rubber bushes, washers & dust boot included.
	OASU0865006-ADJ \$320 ea.	2	<b>Adjustable Internal Bypass</b> - 65mm twin tube. Threaded variable height spring seat. Complete set of rubber bushes, washers & dust boot included.
<b>Shock Absorbers</b>	OASU0160041 \$175 ea.	2	<b>Performance</b> - 60mm twin tube. Complete set of rubber bushes included. Steel shroud.
	OASU0165041-ADJ \$220 ea.	2	<b>Adjustable Internal Bypass</b> - 65mm twin tube. Complete set of rubber bushes & dust boot included.
<b>Coil Springs</b> (pair)	OASU1040001 \$260 ea.	1	Trail/Exped - 40mm lift (approx unladen, adj. struts to 50mm) <i>For vehicles with added accessories, use the supplied spacer rings on struts to retain vehicle ride height.</i>
	OASU1030001 \$260 ea.	1	Exped HD - 40mm lift (@ approx 100kg load, adj. struts) <i>Suits vehicles with heavy bullbar &amp; winch combinations. Heavier spring rate than OASU1040001.</i>
<b>Leaf Springs</b>	OASU1140001 \$250 ea.	2	Trail - 40mm lift (approx unladen) <i>4 primary + 2 secondary</i>
	OASU1140005 \$275 ea.	2	Expedition - 40mm lift (@ approx 150kg load) <i>4 primary + 3 secondary</i>
	OASU1140002 \$300 ea.	2	Expedition HD - 40mm lift (@ approx 300kg load) <i>5 primary + 2 secondary</i>
	OASU1140003 \$340 ea.	2	Expedition XHD - 40mm lift (@ approx 600kg load) <i>6 primary + 2 secondary</i>
<i>** Refer leaf spring graph following for approximate deflections under load.</i>			
<b>Leaf Spring Bush Kit</b>	OASU210023K \$120 kit	1	12 polyurethane bushes & 2 inner tubes
<b>U-bolts</b>	OASU2362001 \$15 ea.	4	Suits leaf springs: OASU1140001, OASU1140002 & OASU1140005 <i>M14 x 62 ID (SQR) x 185 L</i>
	OASU2362002 \$15 ea.	4	Suits leaf springs: OASU1140003 <i>M14 x 62 ID (SQR) x 195 L</i>
<b>Pins</b>	OASU2500042 \$20 ea.	2	Greasable, hardened steel
<b>Shackles</b>	OASU2400052 \$35 ea.	2	Greasable, hardened steel pins

## ACCESSORY ITEMS & CORRECTION COMPONENTS

<b>Bump Stops</b>	OASU4210004 \$165 kit	1	Rear - Rubber, extended progressive rate (2x 110mm).
<b>Strut Mount</b>	OASU0740001 \$80 ea.	2	Supplied with all required nuts, washers and bushes.

\* Ride heights approximate only, based on standard dual cab style-side ute with no additional load, unless otherwise stated.

\* Outback Armour recommend that a minimum of two thirds of the original suspension travel in each direction is retained for optimal performance and durability.

**NISSAN NAVARA D40 (4CYL & V6 PETROL)**

2005 - 2015

**SUSPENSION KITS - FRONT****PERFORMANCE**

v

**ADJ. INTERNAL BYPASS**

v

Lift front: 40mm (approx, height adjustable struts to 50mm)

Suits vehicles with oem bumper, bullbar or winch

**Trail & Expedition**

OASU914000T

\$700 kit

OASU914000T-ADJ

\$900 kit

2x OASU0860006 (struts)

2x OASU0865006-ADJ (struts)

\* kit prices include struts listed above plus the following parts \*

1x OASU1040001 (coil springs)

Coil spring seat spacers included with struts for height adjustment.

Lift front: 40mm (@ approx 100kg load, height adjustable struts to 50mm)

Suits vehicles with heavy bullbar, winch and front loads

**Expedition HD**

OASU914000H

\$700 kit

OASU914000H-ADJ

\$900 kit

2x OASU0860006 (struts)

2x OASU0865006-ADJ (struts)

\* kit prices include struts listed above plus the following parts \*

1x OASU1030001 (coil springs)

Coil spring seat spacers included with struts for height adjustment.

Lift front: 50mm (@ approx 0-50kg load)

Suits vehicles with oem bumper or light front loads

**° Assembled Struts - Trail**

OASU934000T

\$880 pr.

OASU934000T-ADJ

\$1,080 pr.

2x OASU394000T (each)

2x OASU394000T-ADJ (each)

Assembled struts include: struts, coil springs &amp; top mounts.

Lift front: 50mm (@ approx 50-100kg load)

Suits vehicles with a steel bullbar or medium front loads

**° Assembled Struts - Exped**

OASU934000E

\$880 pr.

OASU934000E-ADJ

\$1,080 pr.

2x OASU394000E (each)

2x OASU394000E-ADJ (each)

Assembled struts include: struts, coil springs &amp; top mounts.

Lift front: 50mm (@ approx 100-150kg load)

Suits vehicles with a steel bullbar &amp; winch or heavy front loads

**° Assembled Struts - Exped HD**

OASU934000H

\$880 pr.

OASU934000H-ADJ

\$1,080 pr.

2x OASU394000H (each)

2x OASU394000H-ADJ (each)

Assembled struts include: struts, coil springs &amp; top mounts.

Lift heights are approximate and may vary depending on vehicle or product tolerances and load distribution.

# NISSAN NAVARA D40 (4CYL & V6 PETROL)

2005 - 2015



## SUSPENSION KITS - REAR

PERFORMANCE v	ADJ. INTERNAL BYPASS v	
------------------	---------------------------	--

### Trail

Lift rear: 40mm (approx unladen)  
Suits vehicles with light or occasional medium loads

OASU924000T <b>\$1,140 kit</b>	OASU924000T-ADJ <b>\$1,230 kit</b>	
2x OASU0160041 (shocks)	2x OASU0165041-ADJ (shocks)	

\* kit prices include shock absorbers listed above plus the following parts \*

1x OASU210023K (bush kit)	2x OASU1140001 (leaf springs)	2x OASU2500042 (pins)
4x OASU2362001 (u-bolts)		2x OASU2400052 (shackles)

Rear bump stop kit "OASU4210004" highly recommended to reduce risk of component damage at full compression.

### Expedition

Lift rear: 40mm (@ approx 150kg load)  
Suits vehicles with constant medium or occasional heavy loads

OASU924000E <b>\$1,190 kit</b>	OASU924000E-ADJ <b>\$1,280 kit</b>	
2x OASU0160041 (shocks)	2x OASU0165041-ADJ (shocks)	

\* kit prices include shock absorbers listed above plus the following parts \*

1x OASU210023K (bush kit)	2x OASU1140005 (leaf springs)	2x OASU2500042 (pins)
4x OASU2362001 (u-bolts)		2x OASU2400052 (shackles)

Rear bump stop kit "OASU4210004" highly recommended to reduce risk of component damage at full compression.

### Expedition HD

Lift rear: 40mm (@ approx 300kg load)  
Suits vehicles with constant heavy loads

OASU924000H <b>\$1,240 kit</b>	OASU924000H-ADJ <b>\$1,330 kit</b>	
2x OASU0160041 (shocks)	2x OASU0165041-ADJ (shocks)	

\* kit prices include shock absorbers listed above plus the following parts \*

1x OASU210023K (bush kit)	2x OASU1140002 (leaf springs)	2x OASU2500042 (pins)
4x OASU2362001 (u-bolts)		2x OASU2400052 (shackles)

Rear bump stop kit "OASU4210004" highly recommended to reduce risk of component damage at full compression.

### Expedition XHD

Lift rear: 40mm (@ approx 600kg load)  
Suits vehicles with constant heavy loads

OASU924000X <b>\$1,320 kit</b>	OASU924000X-ADJ <b>\$1,410 kit</b>	
2x OASU0160041 (shocks)	2x OASU0165041-ADJ (shocks)	

\* kit prices include shock absorbers listed above plus the following parts \*

1x OASU210023K (bush kit)	2x OASU1140003 (leaf springs)	2x OASU2500042 (pins)
4x OASU2362002 (u-bolts)		2x OASU2400052 (shackles)

Rear bump stop kit "OASU4210004" highly recommended to reduce risk of component damage at full compression.

## RECOMMENDED OPTIONS & UPGRADES

<b>Jounce Stop Kit - Rear</b>	Parts included:	
OASU4210004 <b>\$165 kit</b>	2x OASU4210104 (jounce stops)	2x OASU4210103 (u-bolt plate)
	Rubber, extended progressive rate (110mm).	
	Recommended to be installed in all vehicles with heavy rear loads.	

Lift heights are approximate and may vary depending on vehicle & product tolerances and load distribution.

# NISSAN NAVARA D40 (4CYL & V6 PETROL)

2005 - 2015



PRODUCT	PART NO.	DETAILS
Leaf Springs	OASU1140001	Trail - 35mm lift (approx unladen) 4 primary + 2 secondary
	OASU1140005	Expedition - 40mm lift (@ approx 150kg) 4 primary + 3 secondary
	OASU1140002	Expedition - 40mm lift (@ approx 300kg) 5 primary + 2 secondary
	OASU1140003	Expedition HD - 40mm lift (@ approx 600kg load) 6 primary + 2 secondary

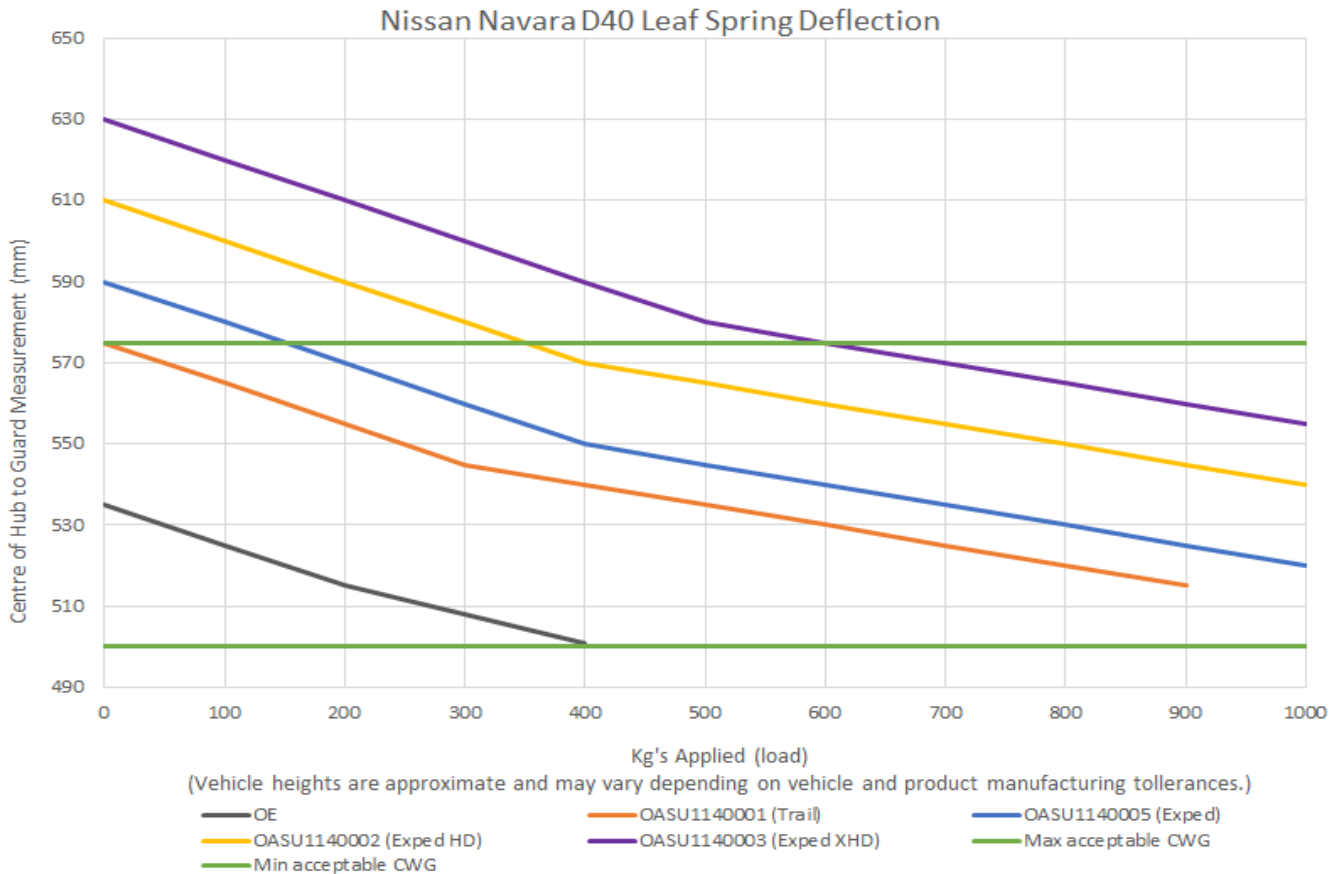

\* CWG (Centre Wheel to Guard) measured from centre of wheel to under-side of guard.

\* Max/Min Acceptable CWG are shown as a recommended guideline only.

\* CWG Heights approximate only, based on a standard dual cab style-side ute with no additional load.

Notes:

# NISSAN NAVARA D40 (V6 DIESEL)

2005 - 2016



PRODUCT	PART NO.	QTY	DETAILS
<b>Struts</b> Max CWG: 560	OASU0860006 \$220 ea.	2	<b>Performance</b> - 60mm twin tube. Spacer ring adjustable height spring seat. Complete set of rubber bushes, washers & dust boot included.
	OASU0865006-ADJ \$320 ea.	2	<b>Adjustable Internal Bypass</b> - 65mm twin tube. Threaded variable height spring seat. Complete set of rubber bushes, washers & dust boot included.
<b>Shock Absorbers</b>	OASU0160041 \$175 ea.	2	<b>Performance</b> - 60mm twin tube. Complete set of rubber bushes included. Steel shroud.
	OASU0165041-ADJ \$220 ea.	2	<b>Adjustable Internal Bypass</b> - 65mm twin tube. Complete set of rubber bushes & dust boot included.
<b>Coil Springs</b> (pair)	OASU1030001 \$260 ea.	1	Trail (V6D) - 40mm lift (approx unladen, adj. struts to 50mm) <i>These coils must be used on all V6 diesel engines. Spring seat spacers supplied with struts to adjust ride height.</i>
<b>Leaf Springs</b>	OASU1140001 \$250 ea.	2	Trail - 40mm lift (approx unladen) <i>4 primary + 2 secondary</i>
	OASU1140005 \$275 ea.	2	Expedition - 40mm lift (@ approx 150kg load) <i>4 primary + 3 secondary</i>
	OASU1140002 \$300 ea.	2	Expedition HD - 40mm lift (@ approx 300kg load) <i>5 primary + 2 secondary</i>
	OASU1140003 \$340 ea.	2	Expedition XHD - 40mm lift (@ approx 600kg load) <i>6 primary + 2 secondary</i>
<i>** Refer leaf spring graph following for approximate deflections under load.</i>			
<b>Leaf Spring Bush Kit</b>	OASU210023K \$120 kit	1	12 polyurethane bushes & 2 inner tubes
<b>U-bolts</b>	OASU2362001 \$15 ea.	4	Suits leaf springs: OASU1140001, OASU1140002 & OASU1140005 <i>M14 x 62 ID (SQR) x 185 L</i>
	OASU2362002 \$15 ea.	4	Suits leaf springs: OASU1140003 <i>M14 x 62 ID (SQR) x 195 L</i>
<b>Pins</b>	OASU2500042 \$20 ea.	2	Greasable, hardened steel
<b>Shackles</b>	OASU2400052 \$35 ea.	2	Greasable, hardened steel pins

## ACCESSORY ITEMS & CORRECTION COMPONENTS

<b>Bump Stops</b>	OASU4210004 \$165 kit	1	Rear - Rubber, extended progressive rate (2x 110mm).
<b>Strut Mount</b>	OASU0740001 \$70 ea.	2	Supplied with all required nuts, washers and bushes.

\* Ride heights approximate only, based on standard dual cab style-side ute with no additional load, unless otherwise stated.

\* Outback Armour recommend that a minimum of two thirds of the original suspension travel in each direction is retained for optimal performance and durability.

# NISSAN NAVARA D40 (V6 DIESEL)

2005 - 2015



## SUSPENSION KITS - FRONT

PERFORMANCE v	ADJ. INTERNAL BYPASS v	
------------------	---------------------------	--

Lift front: 40mm (approx, height adjustable struts to 50mm)  
Suits vehicles with oem bumper, bullbar or winch

### Trail & Expedition

OASU914001T \$700 kit	OASU914001T-ADJ \$900 kit	
2x OASU0860006 (struts)	2x OASU0865006-ADJ (struts)	

\* kit prices include struts listed above plus the following parts \*

1x OASU1030001 (coil springs)

Coil spring seat spacers included with struts for height adjustment.

Lift front: 50mm (@ approx 0-50kg load)

Suits vehicles with oem bumper or light front loads

### ° Assembled Struts - Trail

OASU934001T \$880 pr.	OASU934001T-ADJ \$1,080 pr.	
2x OASU394001T (each)	2x OASU394001T-ADJ (each)	

Assembled struts include: struts, coil springs & top mounts.

Lift front: 50mm (@ approx 50-100kg load)

Suits vehicles with a steel bullbar or medium front loads

### ° Assembled Struts - Exped

OASU934001E \$880 pr.	OASU934001E-ADJ \$1,080 pr.	
2x OASU394001E (each)	2x OASU394001E-ADJ (each)	

Assembled struts include: struts, coil springs & top mounts.

Lift front: 50mm (@ approx 100-150kg load)

Suits vehicles with a steel bullbar & winch or heavy front loads

### ° Assembled Struts - Exped HD

OASU934001H \$880 pr.	OASU934001H-ADJ \$1,080 pr.	
2x OASU394001H (each)	2x OASU394001H-ADJ (each)	

Assembled struts include: struts, coil springs & top mounts.

Lift heights are approximate and may vary depending on vehicle or product tolerances and load distribution.



# NISSAN NAVARA D40 (V6 DIESEL)

2005 - 2015



## SUSPENSION KITS - REAR

PERFORMANCE v	ADJ. INTERNAL BYPASS v	
------------------	---------------------------	--

### Trail Lift rear: 40mm (approx unladen) Suits vehicles with light or occasional medium loads

OASU924000T <b>\$1,140 kit</b>	OASU924000T-ADJ <b>\$1,230 kit</b>	
2x OASU0160041 (shocks)	2x OASU0165041-ADJ (shocks)	

\* kit prices include shock absorbers listed above plus the following parts \*

1x OASU210023K (bush kit)	2x OASU1140001 (leaf springs)	2x OASU2500042 (pins)
4x OASU2362001 (u-bolts)		2x OASU2400052 (shackles)

Rear bump stop kit "OASU4210004" highly recommended to reduce risk of component damage at full compression.

### Expedition Lift rear: 40mm (@ approx 150kg load) Suits vehicles with constant medium or occasional heavy loads

OASU924000E <b>\$1,190 kit</b>	OASU924000E-ADJ <b>\$1,280 kit</b>	
2x OASU0160041 (shocks)	2x OASU0165041-ADJ (shocks)	

\* kit prices include shock absorbers listed above plus the following parts \*

1x OASU210023K (bush kit)	2x OASU1140005 (leaf springs)	2x OASU2500042 (pins)
4x OASU2362001 (u-bolts)		2x OASU2400052 (shackles)

Rear bump stop kit "OASU4210004" highly recommended to reduce risk of component damage at full compression.

### Expedition HD Lift rear: 40mm (@ approx 300kg load) Suits vehicles with constant heavy loads

OASU924000H <b>\$1,240 kit</b>	OASU924000H-ADJ <b>\$1,330 kit</b>	
2x OASU0160041 (shocks)	2x OASU0165041-ADJ (shocks)	

\* kit prices include shock absorbers listed above plus the following parts \*

1x OASU210023K (bush kit)	2x OASU1140002 (leaf springs)	2x OASU2500042 (pins)
4x OASU2362001 (u-bolts)		2x OASU2400052 (shackles)

Rear bump stop kit "OASU4210004" highly recommended to reduce risk of component damage at full compression.

### Expedition XHD Lift rear: 40mm (@ approx 600kg load) Suits vehicles with constant heavy loads

OASU924000X <b>\$1,320 kit</b>	OASU924000X-ADJ <b>\$1,410 kit</b>	
2x OASU0160041 (shocks)	2x OASU0165041-ADJ (shocks)	

\* kit prices include shock absorbers listed above plus the following parts \*

1x OASU210023K (bush kit)	2x OASU1140003 (leaf springs)	2x OASU2500042 (pins)
4x OASU2362002 (u-bolts)		2x OASU2400052 (shackles)

Rear bump stop kit "OASU4210004" highly recommended to reduce risk of component damage at full compression.

## RECOMMENDED OPTIONS & UPGRADES

<b>Jounce Stop Kit - Rear</b>	Parts included:
OASU4210004 <b>\$165 kit</b>	2x OASU4210104 (jounce stops)      2x OASU4210103 (u-bolt plate) Rubber, extended progressive rate (110mm). Recommended to be installed in all vehicles with heavy rear loads.

Lift heights are approximate and may vary depending on vehicle & product tolerances and load distribution.



# NISSAN NAVARA D40 (V6 DIESEL)

2005 - 2015



PRODUCT	PART NO.	DETAILS
Leaf Springs	OASU1140001	Trail - 35mm lift (approx unladen) 4 primary + 2 secondary
	OASU1140005	Expedition - 40mm lift (@ approx 150kg) 4 primary + 3 secondary
	OASU1140002	Expedition - 40mm lift (@ approx 300kg) 5 primary + 2 secondary
	OASU1140003	Expedition HD - 40mm lift (@ approx 600kg load) 6 primary + 2 secondary

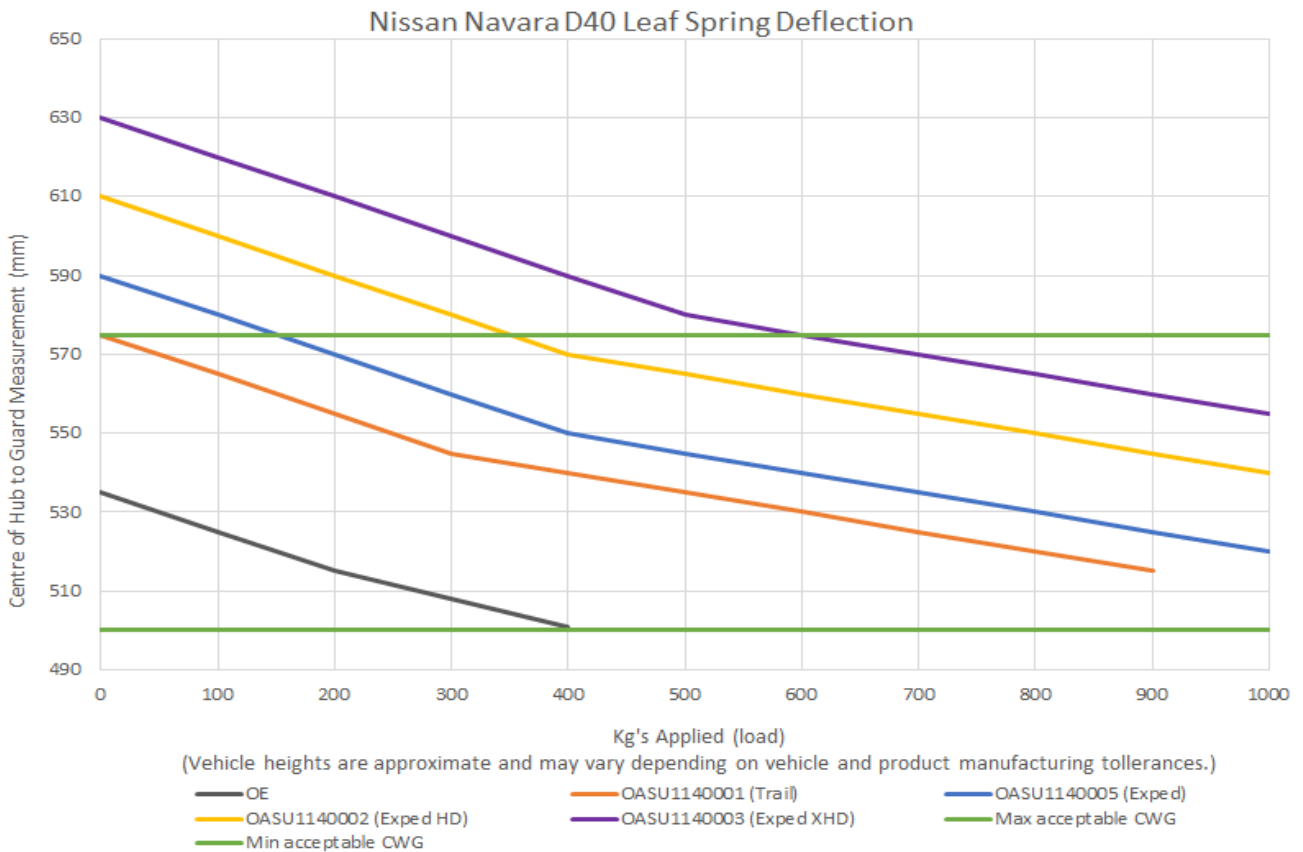

\* CWG (Centre Wheel to Guard) measured from centre of wheel to under-side of guard.

\* Max/Min Acceptable CWG are shown as a recommended guideline only.

\* CWG Heights approximate only, based on a standard dual cab style-side ute with no additional load.

Notes:

# NISSAN NAVARA NP300 (COIL REAR)

2015 +



PRODUCT	PART NO.	QTY	DETAILS
<b>Struts</b> Max CWG: 575	OASU0860006 \$220 ea.	2	<b>Performance</b> - 60mm twin tube. Spacer ring adjustable height spring seat. Complete set of rubber bushes, washers & dust boot included.
	OASU0865006-ADJ \$320 ea.	2	<b>Adjustable Internal Bypass</b> - 65mm twin tube. Threaded variable height spring seat. Complete set of rubber bushes, washers & dust boot included.
<b>Shock Absorbers</b>	OASU0160021 \$175 ea.	2	<b>Performance</b> - 60mm twin tube. Complete set of rubber bushes included. Steel shroud.
	OASU0160021-ADJ \$220 ea.	2	<b>Adjustable Internal Bypass</b> - 60mm twin tube. Complete set of rubber bushes & dust boot included.
<b>Coil Springs</b> (pair)	OASU1040001 \$260 ea.	1	Trail/Exped - 35mm lift (approx unladen, adj. struts to 50mm) <i>For vehicles with added accessories, use the supplied spacer rings on struts to retain vehicle ride height.</i>
	OASU1030001 \$260 ea.	1	Exped HD - 35mm lift (@ approx 100kg load, adj. struts) <i>Suits vehicles with heavy bullbar &amp; winch combinations. Heavier spring rate than OASU1040001.</i>
<b>Coil Springs</b> (rear pair)	OASU1030002 \$260 pr.	1	Trail - 35mm lift (approx unladen)
	OASU1030004 \$260 pr.	1	Expedition - 35mm lift (@ approx 150kg load)
	OASU1030006 \$325 pr.	1	Expedition HD - 35mm lift (@ approx 300kg load)
<i>** Refer coil spring graph following for approximate deflections under load.</i>			

## ACCESSORY ITEMS & CORRECTION COMPONENTS

<b>Bump Stops</b>	OASU4230004 \$95 kit.	1	Rear - Rubber, extended progressive rate (2x 110mm).
<b>Headlight Adjustment Bracket</b>	OASU3730002 \$30 ea.	1	Bracket required to adjust headlight angle on lifted vehicles with HID headlights.
<b>Sway Bar Relocation Kit</b>	OASU3730004 \$30 ea.	1	Relocates the sway bar mounting point to original position. Must have on all lifted vehicles.
<b>Strut Mount</b>	OASU0740001 \$80 ea.	2	Supplied with all required nuts, washers and bushes.

\* Ride heights approximate only, based on standard dual cab style-side ute with no additional load, unless otherwise stated.

\* Outback Armour recommend that a minimum of two thirds of the original suspension travel in each direction is retained for optimal performance and durability.

## RECOMMENDED RECOVERY GEAR

<b>Snatch Strap</b>	OASS6T9M	1	Dynamic Snatch Strap - 6T/9M (2.00T - 3.00T)
<b>Recovery Kits</b>	OAQUICKSKST	1	Quick Snatch Kit - Small Truck
	OACOMPSKST	1	Comp Snatch Kit - Small Truck
	OAWINCHKIT	1	Winch Utility Kit

\*\* Complete range of Outback Armour recovery gear available at rear of this guide.

Notes:

# NISSAN NAVARA NP300 (COIL REAR)

2015 +



## SUSPENSION KITS - FRONT

PERFORMANCE

v

ADJ. INTERNAL BYPASS

v

Lift front: 35mm (approx, height adjustable struts to 50mm)

Suits vehicles with oem bumper, bullbar or winch

### Trail & Expedition

OASU913000T \$700 kit	OASU913000T-ADJ \$900 kit	
2x OASU0860006 (struts)	2x OASU0865006-ADJ (struts)	

\* kit prices include struts listed above plus the following parts \*

1x OASU1040001 (coil springs)

Coil spring seat spacers included with struts for height adjustment.

Lift front: 35mm (@ approx 100kg load, height adjustable struts to 50mm)

Suits vehicles with heavy bullbar, winch and front loads

### Expedition HD

OASU913000H \$700 kit	OASU913000H-ADJ \$900 kit	
2x OASU0860006 (struts)	2x OASU0865006-ADJ (struts)	

\* kit prices include struts listed above plus the following parts \*

1x OASU1030001 (coil springs)

Coil spring seat spacers included with struts for height adjustment.

Lift front: 50mm (@ approx 0-50kg load)

Suits vehicles with oem bumper or light front loads

### ° Assembled Struts - Trail

OASU933000T \$880 pr.	OASU933000T-ADJ \$1,080 pr.	
2x OASU393000T (each)	2x OASU393000T-ADJ (each)	

Assembled struts include: struts, coil springs & top mounts.

Lift front: 50mm (@ approx 50-100kg load)

Suits vehicles with a steel bullbar or medium front loads

### ° Assembled Struts - Exped

OASU933000E \$880 pr.	OASU933000E-ADJ \$1,080 pr.	
2x OASU393000E (each)	2x OASU393000E-ADJ (each)	

Assembled struts include: struts, coil springs & top mounts.

Lift front: 50mm (@ approx 100-150kg load)

Suits vehicles with a steel bullbar & winch or heavy front loads

### ° Assembled Struts - Exped HD

OASU933000H \$880 pr.	OASU933000H-ADJ \$1,080 pr.	
2x OASU393000H (each)	2x OASU393000H-ADJ (each)	

Assembled struts include: struts, coil springs & top mounts.

Lift heights are approximate and may vary depending on vehicle or product tolerances and load distribution.

# NISSAN NAVARA NP300 (COIL REAR)

2015 +



## SUSPENSION KITS - REAR

PERFORMANCE v	ADJ. INTERNAL BYPASS v	
------------------	---------------------------	--

**Trail** Lift rear: 35mm (approx unladen)  
Suits vehicles with light or occasional medium loads

OASU923000T <b>\$670 kit</b>	OASU923000T-ADJ <b>\$760 kit</b>	
2x OASU0160021 (shocks)	2x OASU0160021-ADJ (shocks)	

\* kit prices include shock absorbers listed above plus the following parts \*

1x OASU3730002 (HID adjust.)      1 pair OASU1030002 (coil springs)      1x OASU3730004 (sway bar reloc.)  
Rear bump stop kit "OASU4230004" highly recommended to reduce risk of component damage at full compression.  
HID headlight adjustment bracket and sway bar relocation kits included.

**Expedition** Lift rear: 35mm (@ approx 150kg load)  
Suits vehicles with constant medium or occasional heavy loads

OASU923000E <b>\$670 kit</b>	OASU923000E-ADJ <b>\$760 kit</b>	
2x OASU0160021 (shocks)	2x OASU0160021-ADJ (shocks)	

\* kit prices include shock absorbers listed above plus the following parts \*

1x OASU3730002 (HID adjust.)      1 pair OASU1030004 (coil springs)      1x OASU3730004 (sway bar reloc.)  
Rear bump stop kit "OASU4230004" highly recommended to reduce risk of component damage at full compression.  
HID headlight adjustment bracket and sway bar relocation kits included.

**Expedition HD** Lift rear: 35mm (@ approx 300kg load)  
Suits vehicles with constant heavy loads

OASU923000H <b>\$735 kit</b>	OASU923000H-ADJ <b>\$825 kit</b>	
2x OASU0160021 (shocks)	2x OASU0160021-ADJ (shocks)	

\* kit prices include shock absorbers listed above plus the following parts \*

1x OASU3730002 (HID adjust.)      1 pair OASU1030006 (coil springs)      1x OASU3730004 (sway bar reloc.)  
Rear bump stop kit "OASU4230004" highly recommended to reduce risk of component damage at full compression.  
HID headlight adjustment bracket and sway bar relocation kits included.

### RECOMMENDED OPTIONS & UPGRADES

<b>Jounce Stop Kit - Rear</b>	Parts included:	
OASU4230004 <b>\$110 kit</b>	2x OASU4210104 (jounce stops)	2x OASU4210105 (stud kit)
	Rubber, extended progressive rate (110mm).	
	Recommended to be installed in all vehicles with heavy rear loads.	

Lift heights are approximate and may vary depending on vehicle & product tolerances and load distribution.

# NISSAN NAVARA NP300 (COIL REAR)

2015 +



PRODUCT	PART NO.	DETAILS
Coil Springs	OASU1030002	Trail - 35mm lift (approx unladen) <i>progressive rate coil</i>
	OASU1030004	Expedition - 35mm lift (@ approx 150kg) <i>progressive rate coil</i>
	OASU1030006	Expedition HD - 35mm lift (@ approx 300kg load) <i>progressive rate coil</i>

Nissan Navara NP300 Coil Spring Deflection

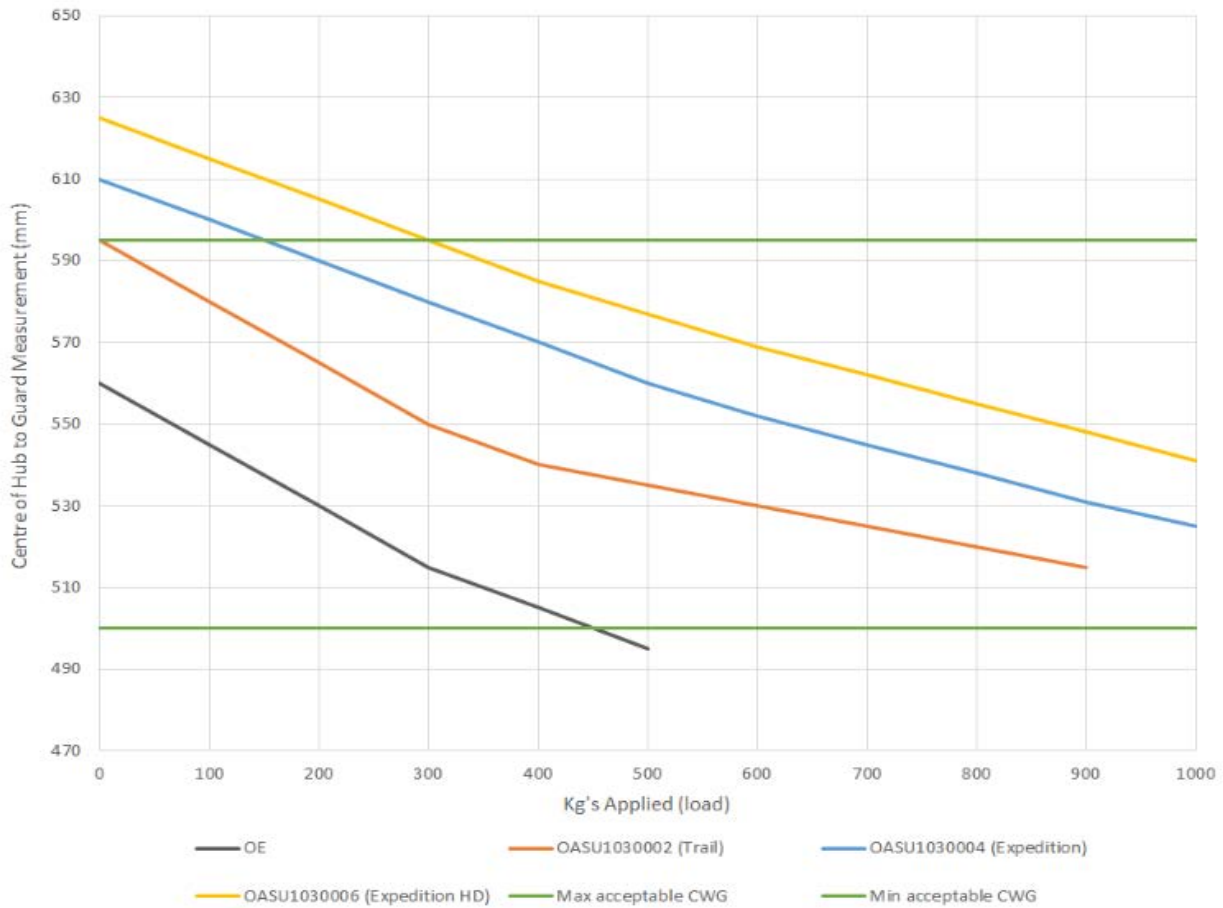

\* CWG (Centre Wheel to Guard) measured from centre of wheel to under-side of guard.

\* Max/Min Acceptable CWG are shown as a recommended guideline only.

\* CWG Heights approximate only, based on a standard dual cab style-side ute with no additional load.

Notes:

# NISSAN NAVARA NP300 (LEAF REAR)

2015 +



PRODUCT	PART NO.	QTY	DETAILS
<b>Struts</b> Max CWG: 575	OASU0860006 \$220 ea.	2	<b>Performance</b> - 60mm twin tube. Spacer ring adjustable height spring seat. Complete set of rubber bushes, washers & dust boot included.
	OASU0865006-ADJ \$320 ea.	2	<b>Adjustable Internal Bypass</b> - 65mm twin tube. Threaded variable height spring seat. Complete set of rubber bushes, washers & dust boot included.
<b>Shock Absorbers</b>	OASU0160019 \$175 ea.	2	<b>Performance</b> - 60mm twin tube. Complete set of rubber bushes & dust boot included.
<b>Coil Springs</b> (pair)	OASU1040001 \$260 ea.	1	Trail/Exped - 40mm lift (approx unladen, adj. struts to 50mm) <i>For vehicles with added accessories, use the supplied spacer rings on struts to retain vehicle ride height.</i>
	OASU1030001 \$260 ea.	1	Exped HD - 40mm lift (@ approx 100kg load, adj. struts) <i>Suits vehicles with heavy bullbar &amp; winch combinations. Heavier spring rate than OASU1040001.</i>
<b>Leaf Springs</b>	OASU1123001 \$285 ea.	2	Trail - 35mm lift (approx unladen) <i>4 primary + 2 secondary</i>
	OASU1123002 \$335 ea.	2	Expedition - 35mm lift (@ approx 150kg load) <i>5 primary + 2 secondary</i>
	OASU1123003 \$360 ea.	2	Expedition HD - 35mm lift (@ approx 300kg load) <i>5 primary + 3 secondary</i>
<i>** Refer leaf spring graph following for approximate deflections under load.</i>			
<b>Leaf Spring Bush Kit</b>	OASU210032K \$120 kit	1	12 polyurethane bushes & 2 inner tubes
<b>U-bolts</b>	OASU2384007 \$15 ea.	4	Suits leaf springs: OASU1123001 & OASU1123002 <i>M14 x 84 ID (RND) x 195 L</i>
	OASU2384001 \$15 ea.	4	Suits leaf springs: OASU1123003 <i>M14 x 84 ID (RND) x 215 L</i>
<b>Pins</b>	OASU2500042 \$20 ea.	2	Greasable, hardened steel
<b>Shackles</b>	OASU2400065 \$35 ea.	2	Greasable, hardened steel pins

## ACCESSORY ITEMS & CORRECTION COMPONENTS

<b>Headlight Adjustment Bracket</b>	OASU3730002 \$30 ea.	1	Bracket required to adjust headlight angle on lifted vehicles with HID headlights. (All STX models and some ST models).
<b>Strut Mount</b>	OASU0740001 \$80 ea.	2	Supplied with all required nuts, washers and bushes.

\* Ride heights approximate only, based on standard dual cab style-side ute with no additional load, unless otherwise stated.

\* Outback Armour recommend that a minimum of two thirds of the original suspension travel in each direction is retained for optimal performance and durability.

## RECOMMENDED RECOVERY GEAR

<b>Snatch Strap</b>	OASS6T9M	1	Dynamic Snatch Strap - 6T/9M (2.00T - 3.00T)
<b>Recovery Kits</b>	OAQUICKSKST	1	Quick Snatch Kit - Small Truck
	OACOMPSKST	1	Comp Snatch Kit - Small Truck
	OAWINCHKIT	1	Winch Utility Kit

\*\* Complete range of Outback Armour recovery gear available at rear of this guide.

# NISSAN NAVARA NP300 (LEAF REAR)

2015 +



## SUSPENSION KITS - FRONT

**PERFORMANCE**

v

**ADJ. INTERNAL BYPASS**

v

Lift front: 40mm (approx, height adjustable struts to 50mm)

Suits vehicles with oem bumper, bullbar or winch

### Trail & Expedition

OASU913000T

\$700 kit

OASU913000T-ADJ

\$900 kit

2x OASU0860006 (struts)

2x OASU0865006-ADJ (struts)

\* kit prices include struts listed above plus the following parts \*

1x OASU1040001 (coil springs)

Coil spring seat spacers included with struts for height adjustment.

Lift front: 40mm (@ approx 100kg load, height adjustable struts to 50mm)

Suits vehicles with heavy bullbar, winch and front loads

### Expedition HD

OASU913000H

\$700 kit

OASU913000H-ADJ

\$900 kit

2x OASU0860006 (struts)

2x OASU0865006-ADJ (struts)

\* kit prices include struts listed above plus the following parts \*

1x OASU1030001 (coil springs)

Coil spring seat spacers included with struts for height adjustment.

Lift front: 50mm (@ approx 0-50kg load)

Suits vehicles with oem bumper or light front loads

### ° Assembled Struts - Trail

OASU933000T

\$880 pr.

OASU933000T-ADJ

\$1,080 pr.

2x OASU393000T (each)

2x OASU393000T-ADJ (each)

Assembled struts include: struts, coil springs & top mounts.

Lift front: 50mm (@ approx 50-100kg load)

Suits vehicles with a steel bullbar or medium front loads

### ° Assembled Struts - Exped

OASU933000E

\$880 pr.

OASU933000E-ADJ

\$1,080 pr.

2x OASU393000E (each)

2x OASU393000E-ADJ (each)

Assembled struts include: struts, coil springs & top mounts.

Lift front: 50mm (@ approx 100-150kg load)

Suits vehicles with a steel bullbar & winch or heavy front loads

### ° Assembled Struts - Exped HD

OASU933000H

\$880 pr.

OASU933000H-ADJ

\$1,080 pr.

2x OASU393000H (each)

2x OASU393000H-ADJ (each)

Assembled struts include: struts, coil springs & top mounts.

Lift heights are approximate and may vary depending on vehicle or product tolerances and load distribution.



# NISSAN NAVARA NP300 (LEAF REAR)

2015 +



## SUSPENSION KITS - REAR

PERFORMANCE v	ADJ. INTERNAL BYPASS v	
------------------	---------------------------	--

**Trail** Lift rear: 35mm (approx unladen)  
Suits vehicles with light or occasional medium loads

OASU923001T <b>\$1,210 kit</b>	Not available for this vehicle	
2x OASU0160019 (shocks)		
* kit prices include shock absorbers listed above plus the following parts *		
1x OASU210032K (bush kit) 4x OASU2384007 (u-bolts)	2x OASU1123001 (leaf springs)	2x OASU2500042 (pins) 2x OASU2400065 (shackles)

**Expedition** Lift rear: 35mm (@ approx 150kg load)  
Suits vehicles with constant medium or occasional heavy loads

OASU923001E <b>\$1,310 kit</b>	Not available for this vehicle	
2x OASU0160019 (shocks)		
* kit prices include shock absorbers listed above plus the following parts *		
1x OASU210032K (bush kit) 4x OASU2384007 (u-bolts)	2x OASU1123002 (leaf springs)	2x OASU2500042 (pins) 2x OASU2400065 (shackles)

**Expedition HD** Lift rear: 35mm (@ approx 300kg load)  
Suits vehicles with constant heavy loads

OASU923001H <b>\$1,360 kit</b>	Not available for this vehicle	
2x OASU0160019 (shocks)		
* kit prices include shock absorbers listed above plus the following parts *		
1x OASU210032K (bush kit) 4x OASU2384001 (u-bolts)	2x OASU1123003 (leaf springs)	2x OASU2500042 (pins) 2x OASU2400065 (shackles)

Lift heights are approximate and may vary depending on vehicle & product tolerances and load distribution.



# NISSAN NAVARA NP300 (LEAF REAR)

2015 +



PRODUCT	PART NO.	DETAILS
Leaf Springs	OASU1023001	Trail - 35mm lift (approx unladen) 4 primary + 2 secondary
	OASU1023002	Expedition - 35mm lift (@ approx 150kg) 5 primary + 2 secondary
	OASU1023003	Expedition HD - 35mm lift (@ approx 300kg load) 5 primary + 3 secondary

Nissan Navara NP300 Leaf Spring Deflection

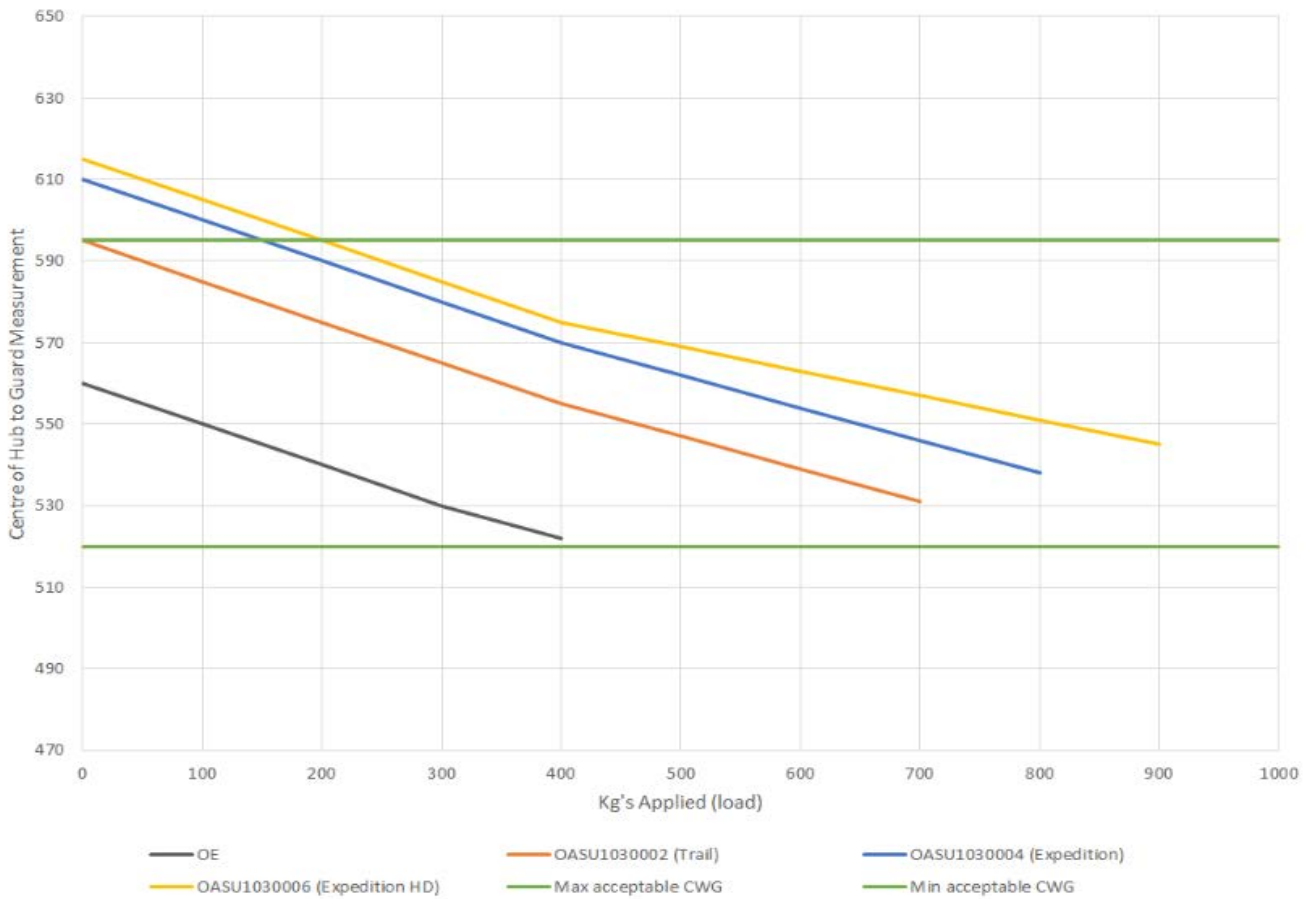

- \* CWG (Centre Wheel to Guard) measured from centre of wheel to under-side of guard.
- \* Max/Min Acceptable CWG are shown as a recommended guideline only.
- \* CWG Heights approximate only, based on a standard dual cab style-side ute with no additional load.

Notes:

# NISSAN PATHFINDER R51

2005 - 2012



PRODUCT	PART NO.	QTY	DETAILS
<b>Struts</b> Max CWG:	OASU0860006 \$220 ea.	2	<b>Performance</b> - 60mm twin tube. Spacer ring adjustable height spring seat. Complete set of rubber bushes, washers & dust boot included.
<b>Shock Absorbers</b>	OASU0154007 \$175 ea.	2	<b>Performance</b> - 54mm twin tube. Complete set of rubber bushes included. Steel shroud.
<b>Coil Springs</b> (front pair)	OASU1040007 \$260 ea.	1	Trail/Exped - 35mm lift (approx unladen, adj. struts to 50mm) <i>Suits 4cyl Diesel variants</i>
	OASU1040001 \$260 ea.	1	Trail/Exped - 35mm lift (approx unladen, adj. struts to 50mm) <i>Suits V6 Diesel variants</i>
<b>Coil Springs</b> (rear pair)	OASU1040002 \$275 ea.	1	Trail - 40mm lift (approx unladen)
	OASU1040004 \$290 ea.	1	Expedition - 40mm lift (@ approx 150kg load)

## ACCESSORY ITEMS & CORRECTION COMPONENTS

<b>Strut Mount</b>	OASU0740001 \$80 ea.	2	Supplied with all required nuts, washers and bushes.
--------------------	-------------------------	---	--

\* Ride heights approximate only, based on standard vehicle with no additional load, unless otherwise stated.

\* Outback Armour recommend that a minimum of two thirds of the original suspension travel in each direction is retained for optimal performance and durability.

## RECOMMENDED RECOVERY GEAR

<b>Snatch Strap</b>	OASS6T9M	1	Dynamic Snatch Strap - 6T/9M (2.00T - 3.00T)
<b>Recovery Kits</b>	OAQUICKSKST	1	Quick Snatch Kit - Small Truck
	OACOMPSKST	1	Comp Snatch Kit - Small Truck
	OAWINCHKIT	1	Winch Utility Kit

\*\* Complete range of Outback Armour recovery gear available at rear of this guide.

Notes:

# NISSAN PATHFINDER R51 (4 CYL DIESEL)

2005 - 2012



## SUSPENSION KITS - FRONT

PERFORMANCE v	ADJ. INTERNAL BYPASS v	
------------------	---------------------------	--

Lift front: 35mm (approx, height adjustable struts to 50mm)  
Suits vehicles with oem bumper, bullbar or winch

### Trail & Expedition

OASU914002T \$700 kit	Not available for this vehicle	
2x OASU0860006 (struts)		

\* kit prices include struts listed above plus the following parts \*

1x OASU1040007 (coil springs)

Coil spring seat spacers included with struts for height adjustment.

Lift front: 50mm (@ approx 0-50kg load)

### ° Assembled Struts - Trail

Suits vehicles with oem bumper or light front loads

OASU934002T \$880 pr.	Not available for this vehicle	
2x OASU394002T (each)		

Assembled struts include: struts, coil springs & top mounts.

Lift front: 50mm (@ approx 50-100kg load)

### ° Assembled Struts - Exped

Suits vehicles with a steel bullbar or medium front loads

OASU934002E \$880 pr.	Not available for this vehicle	
2x OASU394002E (each)		

Assembled struts include: struts, coil springs & top mounts.

Lift front: 50mm (@ approx 100-150kg load)

### ° Assembled Struts - Exped HD

Suits vehicles with a steel bullbar & winch or heavy front loads

OASU934002H \$880 pr.	Not available for this vehicle	
2x OASU394002H (each)		

Assembled struts include: struts, coil springs & top mounts.

Lift heights are approximate and may vary depending on vehicle or product tolerances and load distribution.

# NISSAN PATHFINDER R51 (V6 DIESEL)

2005 - 2012



## SUSPENSION KITS - FRONT

PERFORMANCE v	ADJ. INTERNAL BYPASS v	
------------------	---------------------------	--

Lift front: 35mm (approx, height adjustable struts to 50mm)  
Suits vehicles with oem bumper, bullbar or winch

### Trail & Expedition

OASU914003T <b>\$700 kit</b>	Not available for this vehicle	
2x OASU0860006 (struts)		

\* kit prices include struts listed above plus the following parts \*

1x OASU1040001 (coil springs)

Coil spring seat spacers included with struts for height adjustment.

Lift front: 50mm (@ approx 0-50kg load)

### ° Assembled Struts - Trail

Suits vehicles with oem bumper or light front loads

OASU934003T <b>\$880 pr.</b>	Not available for this vehicle	
2x OASU394003T (each)		

Assembled struts include: struts, coil springs & top mounts.

Lift front: 50mm (@ approx 50-100kg load)

### ° Assembled Struts - Exped

Suits vehicles with a steel bullbar or medium front loads

OASU934003E <b>\$880 pr.</b>	Not available for this vehicle	
2x OASU394003E (each)		

Assembled struts include: struts, coil springs & top mounts.

Lift front: 50mm (@ approx 100-150kg load)

### ° Assembled Struts - Exped HD

Suits vehicles with a steel bullbar & winch or heavy front loads

OASU934003H <b>\$880 pr.</b>	Not available for this vehicle	
2x OASU394003H (each)		

Assembled struts include: struts, coil springs & top mounts.

Lift heights are approximate and may vary depending on vehicle or product tolerances and load distribution.

**NISSAN PATHFINDER R51**

2005 - 2012

**SUSPENSION KITS - REAR****PERFORMANCE**

v

**ADJ. INTERNAL BYPASS**

v

Lift rear: 40mm (approx unladen)

Suits vehicles with light or occasional medium loads

**Trail**

OASU924001T

\$625 kit

Not available for  
this vehicle

2x OASU0154007 (shocks)

\* kit prices include shock absorbers listed above plus the following parts \*

1x OASU1040002 (coil springs)

Lift rear: 40mm (@ approx 150kg load)

Suits vehicles with constant medium or occasional heavy loads

**Expedition**

OASU924001E

\$640 kit

Not available for  
this vehicle

2x OASU0154007 (shocks)

\* kit prices include shock absorbers listed above plus the following parts \*

1x OASU1040004 (coil springs)

Lift heights are approximate and may vary depending on vehicle &amp; product tolerances and load distribution.

# NISSAN PATROL GU Y61 WAGON

1997 +



PRODUCT	PART NO.	QTY	DETAILS
Shock Absorbers (front)	OASU0160014 \$175 ea.	2	<b>Performance</b> - 60mm twin tube. Complete set of rubber bushes and washers included. Steel shroud.
	OASU0165014-ADJ \$220 ea.	2	<b>Adjustable Internal Bypass</b> - 65mm twin tube. Complete set of rubber bushes & dust boot included.
Shock Absorbers (rear)	OASU0160015 \$175 ea.	2	<b>Performance</b> - 60mm twin tube. Nitrogen gas over oil. Complete set of rubber bushes included. Steel shroud.
	OASU0165015-ADJ \$220 ea.	2	<b>Adjustable Internal Bypass</b> - 65mm twin tube. Complete set of rubber bushes & dust boot included.
Steering Damper	OASU0954004 \$150 ea.	1	51mm twin tube foam cell construction. Complete set of bushes and washers included. Steel shroud. <i>Suits: 1999-2000 models with stud type mounts.</i>
	OASU0954003 \$150 ea.	1	51mm twin tube foam cell construction. Complete set of bushes and tapered pins included. Steel shroud. <i>Suits: 2000+ models with tapered pin type mounts.</i>
Coil Springs (front, pair)	OASU1061001 \$260 pr.	1	Trail - 50mm lift (approx unladen)
	OASU1061003 \$260 pr.	1	Expedition - 50mm lift (@ approx 100kg load)
Coil Springs (rear, pair)	OASU1061002 \$390 pr.	1	Trail - 50mm lift (approx unladen)
	OASU1061004 \$390 pr.	1	Expedition - 50mm lift (@ approx 100kg load)
	OASU1061012 \$425 pr.	1	Expedition HD - 50mm lift (@ approx 300kg load)

## ACCESSORY ITEMS & CORRECTION COMPONENTS

Bump Stops	OASU4261002 \$110 kit	1	Front - Rubber, extended progressive rate.
	OASU4261004 \$185 kit	1	Rear - Rubber, extended progressive rate.
Caster Correction Bush Kits	OASU210100K \$200 kit	1	Rubber - 2 degree caster increase (set of 4).
Coil Spring Spacers	OASU2115205 \$50 ea.	2	Front - 15mm, polyurethane
	OASU2115207 \$60 ea.	2	Rear - 15mm, polyurethane

\* Ride heights approximates only, with no additional load, unless otherwise stated.

\* Outback Armour recommend that a minimum of two thirds of the original suspension travel in each direction is retained for optimal performance and durability.

## STEERING DAMPER TYPES

Stud Type Steering

Tapered Pin Type



# NISSAN PATROL GU Y61 WAGON

1997 +



## SUSPENSION KITS - FRONT

**PERFORMANCE**

v

**ADJ. INTERNAL BYPASS**

v

Lift front: 50mm (approx unladen)

Suits vehicles with oem bumper or light front loads

### Trail Kit A

OASU91610TA \$760 kit	OASU91610TA-ADJ \$850 kit	
2x OASU0160014 (shocks)	2x OASU0165014-ADJ (shocks)	

\* kit prices include shock absorbers listed above plus the following parts \*

1x OASU1061001 (coil springs)      1x OASU0954004 (stud type steering damper)

Rear jounce stop kit "OASU4261002" highly recommended to avoid shock absorber damage at full compression.

Steering Damper: Suits '99-'00 models with stud type mounts.

Lift front: 50mm (approx unladen)

Suits vehicles with oem bumper or light front load

### Trail Kit B

OASU91610TB \$760 kit	OASU91610TB-ADJ \$850 kit	
2x OASU0160014 (shocks)	2x OASU0165014-ADJ (shocks)	

\* kit prices include shock absorbers listed above plus the following parts \*

1x OASU1061001 (coil springs)      1x OASU0954003 (tapered pin steering damper)

Rear jounce stop kit "OASU4261002" highly recommended to avoid shock absorber damage at full compression.

Steering Damper: Suits '00+ models with tapered pin type mounts.

Lift front: 50mm (@ approx 100kg load)

Suits vehicles with a steel bullbar, winch or heavy front loads

### Expedition Kit A

OASU91610EA \$760 kit	OASU91610EA-ADJ \$850 kit	
2x OASU0160014 (shocks)	2x OASU0165014-ADJ (shocks)	

\* kit prices include shock absorbers listed above plus the following parts \*

1x OASU1061003 (coil springs)      1x OASU0954004 (stud type steering damper)

Rear jounce stop kit "OASU4261002" highly recommended to avoid shock absorber damage at full compression.

Steering Damper: Suits '99-'00 models with stud type mounts.

Lift front: 50mm (@ approx 100kg load)

Suits vehicles with a steel bullbar, winch or heavy front loads

### Expedition Kit B

OASU91610EB \$760 kit	OASU91610EB-ADJ \$850 kit	
2x OASU0160014 (shocks)	2x OASU0165014-ADJ (shocks)	

\* kit prices include shock absorbers listed above plus the following parts \*

1x OASU1061003 (coil springs)      1x OASU0954003 (tapered pin steering damper)

Rear jounce stop kit "OASU4261002" highly recommended to avoid shock absorber damage at full compression.

Steering Damper: Suits '00+ models with tapered pin type mounts.

## RECOMMENDED OPTIONS & UPGRADES

<b>Caster Correction Front</b> OASU210100K \$200 kit	Parts included: 1x OASU210100K (2 degree caster correction kit) Includes: 4x rubber bushes with fitting instructions.
<b>Jounce Stop Kit - Front</b> OASU4261002 \$110 kit	Parts included: 2x OASU4210104 (jounce stops)      2x (bracket and fitting kit) Rubber, extended progressive rate (110mm). Recommended to be installed in all vehicles with heavy rear loads.

Lift heights are approximate and may vary depending on vehicle or product tolerances and load distribution.

# NISSAN PATROL GU Y61 WAGON

1997 +



## SUSPENSION KITS - REAR

PERFORMANCE v	ADJ. INTERNAL BYPASS v	
------------------	---------------------------	--

### Trail

Lift rear: 50mm (approx unladen)  
Suits vehicles with light or occasional medium loads

OASU926100T <b>\$740 kit</b>	OASU926100T-ADJ <b>\$830 kit</b>	
2x OASU0160015 (shocks)	2x OASU0165015-ADJ (shocks)	

\* kit prices include shock absorbers listed above plus the following parts \*

1 pair OASU1061002 (coil springs)

Rear bump stop kit "OASU4261004" highly recommended to reduce risk of component damage at full compression.

### Expedition

Lift rear: 50mm (@ approx 100kg load)  
Suits vehicles with constant medium or occasional heavy loads

OASU926100E <b>\$740 kit</b>	OASU926100E-ADJ <b>\$830 kit</b>	
2x OASU0160015 (shocks)	2x OASU0165015-ADJ (shocks)	

\* kit prices include shock absorbers listed above plus the following parts \*

1 pair OASU1061004 (coil springs)

Rear bump stop kit "OASU4261004" highly recommended to reduce risk of component damage at full compression.

### Expedition HD

Lift rear: 50mm (@ approx 300kg load)  
Suits vehicles with constant heavy loads

OASU926100H <b>\$775 Kit</b>	OASU926100H-ADJ <b>\$865 Kit</b>	
2x OASU0160015 (shocks)	2x OASU0165015-ADJ (shocks)	

\* kit prices include shock absorbers listed above plus the following parts \*

1 pair OASU1061012 (coil springs)

Rear bump stop kit "OASU4261004" highly recommended to reduce risk of component damage at full compression.

## RECOMMENDED OPTIONS & UPGRADES

<b>Jounce Stop Kit - Rear</b>  OASU4261004 <b>\$185 kit</b>	Parts included: 2x OASU4210104 (jounce stops)   2x (bracket & fitting kit) Rubber, extended progressive rate (110mm). Recommended to be installed in all vehicles with heavy rear loads.
--	---

Lift heights are approximate and may vary depending on vehicle & product tolerances and load distribution.





# TOYOTA FJ CRUISER 15 SERIES

15 Series (2010+)



PRODUCT	PART NO.	QTY	DETAILS
<b>Struts</b> Max CWG: 560	OASU0860003 \$220 ea.	2	<b>Performance</b> - 60mm twin tube. Spacer ring adjustable height spring seat. Complete set of rubber bushes, washers & dust boot included.
	OASU0865003-ADJ \$320 ea.	2	<b>Adjustable Internal Bypass</b> - 65mm twin tube. Threaded variable height spring seat. Complete set of rubber bushes, washers & dust boot included.
<b>Shock Absorbers</b>	OASU0160028 \$175 ea.	2	<b>Performance</b> - 60mm twin tube. Complete set of rubber bushes included. Steel shroud.
	OASU0165028-ADJ \$220 ea.	2	<b>Adjustable Internal Bypass</b> - 65mm twin tube. Complete set of rubber bushes & dust boot included.
<b>Coil Springs</b> (front, pair)	OASU1015001 \$260 pr.	1	Trail/Exped - 45mm lift (approx unladen, adj. struts to 50mm) <i>Suits vehicles with light front loads or bullbars.</i> <i>Springs seat spacers supplied with struts to adjust ride height.</i>
	OASU1015003 \$260 pr.	1	Expedition HD - 50mm lift (@ approx 100kg load) <i>Suits vehicles with bullbar &amp; winch applications.</i> <i>Springs seat spacers supplied with struts to adjust ride height.</i>
<b>Coil Springs</b> (rear, pair)	OASU1015002 \$260 pr.	1	Trail - 45mm lift (approx unladen)
	OASU1015004 \$260 pr.	1	Expedition - 45mm lift (@ approx 150kg load)
	OASU1015006 \$330 pr.	1	Expedition HD - 45mm lift (@ approx 350kg load)

## ACCESSORY ITEMS & CORRECTION COMPONENTS

<b>Bump Stops</b>	OASU4210102 \$27.50 ea.	2	Front - Rubber, extended progressive rate (60mm/M10x25mm)
<b>Strut Mount</b>	OASU0715002 \$80 ea.	2	Suits FJ Cruiser 15 Series. Supplied with all required nuts, washers and bushes.

\* Ride heights approximates only, with no additional load, unless otherwise stated.

\* Outback Armour recommend that a minimum of two thirds of the original suspension travel in each direction is retained for optimal performance and durability.

## RECOMMENDED RECOVERY GEAR

<b>Snatch Strap</b>	OASS6T9M	1	Dynamic Snatch Strap - 6T/9M (2.00T - 3.00T)
<b>Recovery Kits</b>	OAQUICKSKST	1	Quick Snatch Kit - Small Truck
	OACOMPSKST	1	Comp Snatch Kit - Small Truck
	OAWINCHKIT	1	Winch Utility Kit

\*\* Complete range of Outback Armour recovery gear available at rear of this guide.

Notes:

# TOYOTA FJ CRUISER 15 SERIES

15 Series (2010+)



## SUSPENSION KITS - FRONT

PERFORMANCE v	ADJ. INTERNAL BYPASS v	
------------------	---------------------------	--

Lift front: 35mm (approx, height adjustable struts to 50mm)  
Suits vehicles with oem bumper, bullbar or light front loads

### Trail & Expedition

OASU911502T \$700 kit	OASU911502T-ADJ \$900 kit	
2x OASU0860003 (struts)	2x OASU0865003-ADJ (struts)	

\* kit prices include struts listed above plus the following parts \*

1x OASU1015001 (coil springs)

Coil spring seat spacers included with struts for height adjustment.

Lift front: 50mm (@ approx 100kg load)

### Expedition HD

Suits vehicles with a steel bullbar, winch or heavy front loads

OASU911502H \$700 kit	OASU911502H-ADJ \$900 kit	
2x OASU0860003 (struts)	2x OASU0865003-ADJ (struts)	

\* kit prices include struts listed above plus the following parts \*

1x OASU1015003 (coil springs)

Coil spring seat spacers included with struts for height adjustment.

Lift front: 50mm (@ approx 0-50kg load)

### ° Assembled Struts - Trail

Suits vehicles with oem bumper or light front loads

OASU931502T \$880 pr.	OASU931502T-ADJ \$1,080 pr.	
2x OASU391502T (each)	2x OASU391502T-ADJ (each)	

Assembled struts include: struts, coil springs & top mounts.

Lift front: 50mm (@ approx 50-100kg load)

### ° Assembled Struts - Exped

Suits vehicles with a steel bullbar or medium front loads

OASU931502E \$880 pr.	OASU931502E-ADJ \$1,080 pr.	
2x OASU391502E (each)	2x OASU391502E-ADJ (each)	

Assembled struts include: struts, coil springs & top mounts.

Lift front: 50mm (@ approx 100-150kg load)

### ° Assembled Struts - Exped HD

Suits vehicles with a steel bullbar & winch or heavy front loads

OASU931502H \$880 pr.	OASU931502H-ADJ \$1,080 pr.	
2x OASU391502H (each)	2x OASU391502H-ADJ (each)	

Assembled struts include: struts, coil springs & top mounts.

## RECOMMENDED OPTIONS & UPGRADES

<b>Jounce Stop Kit - Front</b>  OASU4210202 \$55 kit	Parts included: 2x OASU4210102 (jounce stops) Rubber, extended progressive rate (60mm / M10x25mm). Highly recommended to be installed in all vehicles with bullbars.
---	---

Lift heights are approximate and may vary depending on vehicle or product tolerances and load distribution.

# TOYOTA FJ CRUISER 15 SERIES

15 Series (2010+)



## SUSPENSION KITS - REAR

PERFORMANCE v	ADJ. INTERNAL BYPASS v	
------------------	---------------------------	--

### Trail

Lift rear: 45mm (approx unladen)  
Suits vehicles with light or occasional medium loads

OASU921502T <b>\$610 kit</b>	OASU921502T-ADJ <b>\$700 kit</b>	
2x OASU0160028 (shocks)	2x OASU0165028-ADJ (shocks)	

\* kit prices include shock absorbers listed above plus the following parts \*  
1 pair OASU1015002 (coil springs)

### Expedition

Lift rear: 45mm (@ approx 150kg load)  
Suits vehicles with constant medium or occasional heavy loads

OASU921502E <b>\$610 kit</b>	OASU921502E-ADJ <b>\$700 kit</b>	
2x OASU0160028 (shocks)	2x OASU0165028-ADJ (shocks)	

\* kit prices include shock absorbers listed above plus the following parts \*  
1 pair OASU1015004 (coil springs)

### Expedition HD

Lift rear: 45mm (@ approx 350kg load)  
Suits vehicles with constant heavy loads

OASU921502H <b>\$680 kit</b>	OASU921502H-ADJ <b>\$770 kit</b>	
2x OASU0160028 (shocks)	2x OASU0165028-ADJ (shocks)	

\* kit prices include shock absorbers listed above plus the following parts \*  
1 pair OASU1015006 (coil springs)

Lift heights are approximate and may vary depending on vehicle & product tolerances and load distribution.



# TOYOTA HILUX 150

KUN26R, GGN25R, 4x4, 2005 + (inc. Photon Tunland)



PRODUCT	PART NO.	QTY	DETAILS
<b>Struts</b> Max CWG: 560	OASU0864016 \$220 ea.	2	<b>Performance</b> - 60mm twin tube. Spacer ring adjustable height spring seat. Complete set of rubber bushes, washers & dust boot included.
	OASU0865001-ADJ \$320 ea.	2	<b>Adjustable Internal Bypass</b> - 65mm twin tube. Threaded variable height spring seat. Complete set of rubber bushes, washers & dust boot included.
<b>Shock Absorbers</b>	OASU0160013 \$175 ea.	2	<b>Performance</b> - 60mm twin tube. Complete set of rubber bushes & brake line spacer kit included.
	OASU0165013-ADJ \$220 ea.	2	<b>Adjustable Internal Bypass</b> - 65mm twin tube. Complete set of rubber bushes, brake line spacer kit & dust boot included.
<b>Coil Springs</b> (front, pair)	OASU1015001 \$260 pr.	1	Trail - 35mm lift (approx unladen, adj. struts to 50mm) <i>Suits vehicles with no front accessories. Springs seat spacers supplied with struts to adjust ride height.</i>
	OASU1015003 \$260 pr.	1	Exped - 50mm lift (approx unladen, adj. struts to 50mm) <i>Suits vehicles with bullbars and medium front loads. Springs seat spacers supplied with struts to adjust ride height.</i>
	OASU1015005 \$260 pr.	1	Exped HD - 35mm lift (approx unladen, adj. struts to 50mm) <i>Heavier rate coil for heavy steel bullbar &amp; winch combinations. Springs seat spacers supplied with struts to adjust ride height.</i>
<b>Leaf Springs</b>	OASU1115003 \$250 ea.	2	Trail 35 - 35mm lift (approx unladen) <i>4 primary + 2 secondary</i>
	OASU1115001 \$250 ea.	2	Trail 50 - 50mm lift (approx unladen) <i>4 primary + 2 secondary</i>
	OASU1115002 \$320 ea.	2	Expedition - 50mm lift (@ approx 150kg load) <i>5 primary + 2 secondary</i>
	OASU1115004 \$335 ea.	2	Expedition HD - 50mm lift (@ approx 350kg load) <i>5 primary + 3 secondary</i>
	OASU1115005 \$350 ea.	2	Expedition XHD - 50mm lift (@ approx 700kg load) <i>6 primary + 3 secondary</i>
<i>** Refer leaf spring graph following for approximate deflections under load.</i>			
<b>Leaf Spring Bush Kit</b>	OASU210024K \$125 kit	1	12 polyurethane bushes & 2 inner tubes
<b>U-bolts</b>	OASU2362001 \$15 ea.	4	Suits leaf springs: OASU1115001 & OASU1115003 <i>M14 x 62 ID (SQR) x 185 L</i>
	OASU2362002 \$15 ea.	4	Suits leaf springs: OASU1115002 <i>M14 x 62 ID (SQR) x 195 L</i>
	OASU2362004 \$15 ea.	4	Suits leaf springs: OASU1115004 & OASU1115005 <i>M14 x 62 ID (SQR) x 210 L</i>
<i>** All u-bolts hardened steel, rolled threads, deep nuts &amp; spring washers.</i>			
<b>Pins</b>	OASU2500042 \$20 ea.	2	Greasable, hardened steel
<b>Shackles</b>	OASU2400057 \$35 ea.	2	Greasable, hardened steel pins
<b>ACCESSORY ITEMS &amp; CORRECTION COMPONENTS</b>			
<b>Bump Stops</b>	OASU4210102 \$27.50 ea.	2	Front - Rubber, extended progressive rate (60mm/M10x25mm)
	OASU4210004 \$165 kit	1	Rear - Rubber, extended progressive rate (2x 110mm).
<b>Strut Mount</b>	OASU0715002 \$80 ea.	2	Supplied with all required nuts, washers and bushes.

\* Ride heights approximate only, based on standard dual cab style-side ute with no additional load, unless otherwise stated.

\* Recommend a minimum of two thirds of the original travel in each direction be retained for optimal performance and durability

**TOYOTA HILUX 150**

KUN26R, GGN25R, 4x4, 2005 + (inc. Photon Tunland)

**SUSPENSION KITS - FRONT****PERFORMANCE**

v

**ADJ. INTERNAL BYPASS**

v

Lift front: 35mm (approx, height adjustable struts to 50mm)

Suits vehicles with oem bumper or light front loads

**Trail**

OASU911500T

\$700 kit

OASU911500T-ADJ

\$900 kit

2x OASU0864016 (struts)

2x OASU0865001-ADJ (struts)

\* kit prices include struts listed above plus the following parts \*

1x OASU1015001 (coil springs)

Coil spring seat spacers included with struts for height adjustment.

Lift front: 50mm (approx, height adjustable struts)

Suits vehicles with a steel bullbar or medium front loads

**Expedition**

OASU911500E

\$700 kit

OASU911500E-ADJ

\$900 kit

2x OASU0864016 (struts)

2x OASU0865001-ADJ (struts)

\* kit prices include struts listed above plus the following parts \*

1x OASU1015003 (coil springs)

Lift front: 50mm (approx) height adjustable struts. Coil spring seat spacers included with struts for height adj.

Lift front: 50mm (@ approx 100kg load)

Suits vehicles with a steel bullbar, winch or heavy front loads

**Expedition HD**

OASU911500H

\$700 kit

OASU911500H-ADJ

\$900 kit

2x OASU0864016 (struts)

2x OASU0865001-ADJ (struts)

\* kit prices include struts listed above plus the following parts \*

1x OASU1015005 (coil springs)

Lift front: 50mm (@ approx 100kg load). Coil spring seat spacers included with struts for height adjustment.

Lift front: 50mm (@ approx 0-50kg load)

Suits vehicles with oem bumper or light front loads

**° Assembled Struts - Trail**

OASU931500T

\$880 pr.

OASU931500T-ADJ

\$1,080 pr.

2x OASU391500T (each)

2x OASU391500T-ADJ (each)

Assembled struts include: struts, coil springs &amp; top mounts.

Lift front: 50mm (@ approx 50-100kg load)

Suits vehicles with a steel bullbar or medium front loads

**° Assembled Struts - Exped**

OASU931500E

\$880 pr.

OASU931500E-ADJ

\$1,080 pr.

2x OASU391500E (each)

2x OASU391500E-ADJ (each)

Assembled struts include: struts, coil springs &amp; top mounts.

Lift front: 50mm (@ approx 100-150kg load)

Suits vehicles with a steel bullbar &amp; winch or heavy front loads

**° Assembled Struts - Exped HD**

OASU931500H

\$880 pr.

OASU931500H-ADJ

\$1,080 pr.

2x OASU391500H (each)

2x OASU391500H-ADJ (each)

Assembled struts include: struts, coil springs &amp; top mounts.

**RECOMMENDED OPTIONS & UPGRADES****Jounce Stop Kit - Front**

OASU4210202

\$55 kit

Parts included:

2x OASU4210102 (jounce stops)

Rubber, extended progressive rate (60mm / M10x25mm).

Highly recommended to be installed in all vehicles with bullbars.

Lift heights are approximate and may vary depending on vehicle or product tolerances and load distribution.

**TOYOTA HILUX 150**

KUN26R, GGN25R, 4x4, 2005 + (inc. Photon Tunland)

**SUSPENSION KITS - REAR****PERFORMANCE**

v

**ADJ. INTERNAL BYPASS**

v

**Trail - 35**

Lift rear: 35mm (approx unladen)

Suits vehicles with light or occasional medium loads

OASU92150TA \$1,145 kit	OASU92150TA-ADJ \$1,235 kit	
2x OASU0160013 (shocks)	2x OASU0165013-ADJ (shocks)	

\* kit prices include shock absorbers listed above plus the following parts \*

1x OASU210024K (bush kit)

2x OASU1115003 (leaf springs)

2x OASU2500042 (pins)

4x OASU2362001 (u-bolts)

2x OASU2400057 (shackles)

Rear bump stop kit "OASU4210004" highly recommended to reduce risk of component damage at full compression.

**Trail - 50**

Lift rear: 50mm (approx unladen)

Suits vehicles with light or occasional medium loads

OASU921500T \$1,145 kit	OASU921500T-ADJ \$1,235 kit	
2x OASU0160013 (shocks)	2x OASU0165013-ADJ (shocks)	

\* kit prices include shock absorbers listed above plus the following parts \*

1x OASU210024K (bush kit)

2x OASU1115001 (leaf springs)

2x OASU2500042 (pins)

4x OASU2362001 (u-bolts)

2x OASU2400057 (shackles)

Rear bump stop kit "OASU4210004" highly recommended to reduce risk of component damage at full compression.

**Expedition**

Lift rear: 50mm (@ approx 150kg load)

Suits vehicles with constant medium or occasional heavy loads

OASU921500E \$1,285 kit	OASU921500E-ADJ \$1,375 kit	
2x OASU0160013 (shocks)	2x OASU0165013-ADJ (shocks)	

\* kit prices include shock absorbers listed above plus the following parts \*

1x OASU210024K (bush kit)

2x OASU1115002 (leaf springs)

2x OASU2500042 (pins)

4x OASU2362002 (u-bolts)

2x OASU2400057 (shackles)

Rear bump stop kit "OASU4210004" highly recommended to reduce risk of component damage at full compression.

**Expedition HD**

Lift rear: 50mm (@ approx 350kg load)

Suits vehicles with constant heavy loads

OASU921500H \$1,315 kit	OASU921500H-ADJ \$1,405 kit	
2x OASU0160013 (shocks)	2x OASU0165013-ADJ (shocks)	

\* kit prices include shock absorbers listed above plus the following parts \*

1x OASU210024K (bush kit)

2x OASU1115004 (leaf springs)

2x OASU2500042 (pins)

4x OASU2362004 (u-bolts)

2x OASU2400057 (shackles)

Rear bump stop kit "OASU4210004" highly recommended to reduce risk of component damage at full compression.

Lift heights are approximate and may vary depending on vehicle &amp; product tolerances and load distribution.



## TOYOTA HILUX 150

KUN26R, GGN25R, 4x4, 2005 + (inc. Photon Tunland)



### SUSPENSION KITS - REAR

PERFORMANCE

v

ADJ. INTERNAL BYPASS

v

#### Expedition XHD

Lift rear: 50mm (@ approx 700kg load)  
Suits vehicles with constant heavy loads

OASU921500X

\$1,345 kit

OASU921500X-ADJ

\$1,435 kit

2x OASU0160013 (shocks)

2x OASU0165013-ADJ (shocks)

\* kit prices include shock absorbers listed above plus the following parts \*

1x OASU210024K (bush kit)

2x OASU1115005 (leaf springs)

2x OASU2500042 (pins)

4x OASU2362004 (u-bolts)

2x OASU2400057 (shackles)

Rear bump stop kit "OASU4210004" highly recommended to reduce risk of component damage at full compression.

### RECOMMENDED OPTIONS & UPGRADES

#### Jounce Stop Kit - Rear

OASU4210004

\$165 kit

Parts included:

2x OASU4210103 (u-bolt plate)

2x OASU4210104 (jounce stops)

Rubber, extended progressive rate (110mm).

Recommended to be installed in all vehicles with heavy rear loads.

Lift heights are approximate and may vary depending on vehicle & product tolerances and load distribution.

# TOYOTA HILUX 150

KUN26R, GGN25R, 4x4, 2005 + (inc. Photon Tunland)



PRODUCT	PART NO.	DETAILS
Leaf Springs	OASU1115003	Trail - 35mm lift (approx unladen) 4 primary + 2 secondary
	OASU1115001	Trail 50 - 50mm lift (approx unladen) 4 primary + 2 secondary
	OASU1115002	Expedition - 50mm lift (@ approx 150kg) 5 primary + 2 secondary
	OASU1115004	Expedition HD - 50mm lift (@ approx 350kg load) 5 primary + 3 secondary
	OASU1115005	Expedition XHD - 50mm lift (@ approx 700kg load) 6 primary + 3 secondary

Toyota Hilux 150 Series Leaf Spring Deflection

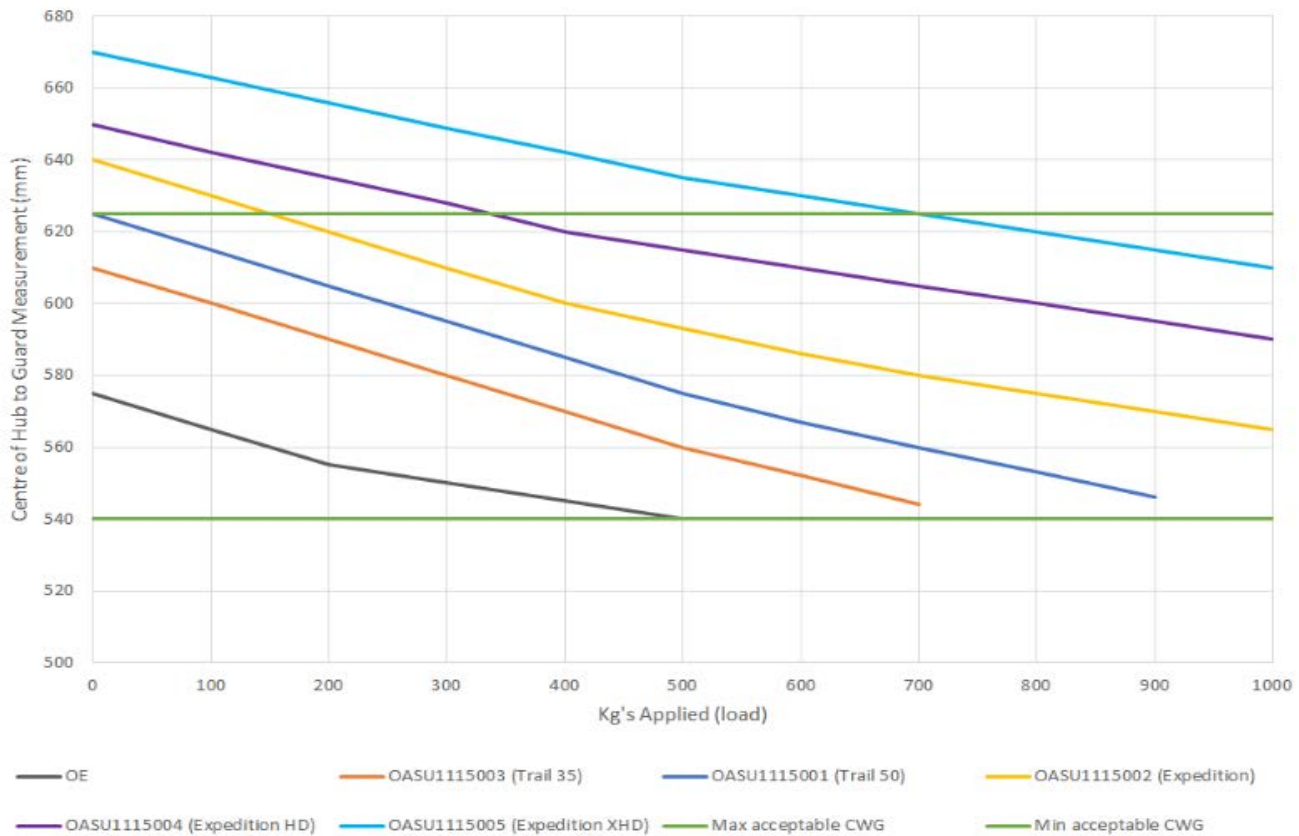

\* CWG (Centre Wheel to Guard) measured from centre of wheel to under-side of guard.

\* Max/Min Acceptable CWG are shown as a recommended guideline only.

\* CWG Heights approximate only, based on a standard dual cab style-side ute with no additional load.

Notes:



**TOYOTA HILUX GENERATION 8**

4x4, 2015 +



PRODUCT	PART NO.	QTY	DETAILS
<b>Struts</b> Max CWG: 565	OASU0864016 \$220 ea.	2	<b>Performance</b> - 60mm twin tube. Spacer ring adjustable height spring seat. Complete set of rubber bushes, washers & dust boot included.
	OASU0865001-ADJ \$320 ea.	2	<b>Adjustable Internal Bypass</b> - 65mm twin tube. Threaded variable height spring seat. Complete rubber bushes, washers & dust boot included.
<b>Shock Absorbers</b>	OASU0164024 \$175 ea.	2	<b>Performance</b> - 60mm twin tube. Complete set of rubber bushes & brake line spacer kit included.
	OASU0165024-ADJ \$220 ea.	2	<b>Adjustable Internal Bypass</b> - 65mm twin tube. Complete set of rubber bushes, brake line spacer kit & dust boot included.
<b>Coil Springs</b> (front, pair)	OASU1015001 \$260 pr.	1	Trail - 35mm lift (approx unladen, adj. struts to 50mm) <i>Suits vehicles with no front accessories. Springs seat spacers supplied with struts to adjust ride height.</i>
	OASU1015003 \$260 pr.	1	Expedition - 50mm lift (approx unladen, adj. struts to 50mm) <i>Suits vehicles with bullbars and medium front loads. Springs seat spacers supplied with struts to adjust ride height.</i>
	OASU1015005 \$260 pr.	1	Exped HD - 35mm lift (approx unladen, adj. struts to 50mm) <i>Heavier rate coil for very heavy steel bullbar &amp; winch combinations (100kg+). Spring seat spacers supplied with struts</i>
<b>Leaf Springs</b>	OASU1116005 \$340 ea.	2	Trail - 35mm lift (approx unladen) <i>5 primary + 3 secondary OEM spring rate - comfort, no additional load carrying capacity.</i>
	OASU1116001 \$310 ea.	2	Trail - 50mm lift (approx unladen) <i>4 primary + 2 secondary</i>
	OASU1116002 \$330 ea.	2	Expedition - 50mm lift (@ approx 200 kg load) <i>4 primary + 2 secondary</i>
	OASU1116003 \$370 ea.	2	Expedition HD - 50mm lift (@ approx 400kg load) <i>5 primary + 3 secondary</i>
	OASU1116004 \$420 ea.	2	Expedition XHD - 50mm lift (@ approx 800kg load) <i>6 primary + 3 secondary</i>
<i>** Refer leaf spring graph following for approximate deflections under load.</i>			
<b>Leaf Spring Bush Kit</b>	OASU210024K \$125 kit	1	12 polyurethane bushes & 2 inner tubes
<b>U-bolts</b>	OASU2362002 \$15 ea.	4	Suits leaf springs: OASU1116001 & OASU1116002 <i>M14 x 62 ID (SQR) x 195 L</i>
	OASU2362004 \$15 ea.	4	Suits leaf springs: OASU1116005 <i>M14 x 62 ID (SQR) x 210 L</i>
	OASU2362005 \$15 ea.	4	Suits leaf springs: OASU1116003 & OASU1116004 <i>M14 x 62 ID (SQR) x 230 L</i>

## TOYOTA HILUX GENERATION 8

4x4, 2015 +



PRODUCT	PART NO.	QTY	DETAILS
<b>Pins</b>	OASU2500042 \$20 ea.	2	Greasable, hardened steel
<b>Shackles</b>	OASU2400064 \$35 ea.	2	Greasable, hardened steel pins

### ACCESSORY ITEMS & CORRECTION COMPONENTS

<b>Bump Stops</b>	OASU4210102 \$27.50 ea.	2	Front - Rubber, extended progressive rate (60mm/M10x25mm)
	OASU4210004 \$165 kit	1	Rear - Rubber, extended progressive rate (110mm).
<b>Centre Bearing Spacer Kit</b>	OASU3715002 \$45 kit	1	Supplied with all required washers, spacers & bolts. Recommended to improve tailshaft angle and reduce vibrations.
<b>SR5 Adjustable Link Rod</b>	OASU3716002 \$12.50 ea.	1	Required for all SR5 models. The adjustable link rod kit allows for HID headlight levelling & shackle grease nipple clearance.
<b>Pin Protector Cap</b>	OASU3716003 \$22 ea.	1	Reduces the chance of the left side leaf spring pin from rupturing the fuel tank in the event of side impact.
<b>Strut Mount</b>	OASU0715002 \$80 ea.	2	Supplied with all required nuts, washers and bushes.

# TOYOTA HILUX GENERATION 8

4x4 2015 +



## SUSPENSION KITS - FRONT

PERFORMANCE v	ADJ. INTERNAL BYPASS v	
------------------	---------------------------	--

### Trail

Lift front: up to 50mm (approx) height adjustable struts  
Suits vehicles with oem bumper or light front loads

OASU911600T \$700 kit	OASU911600T-ADJ \$900 kit	
2x OASU0864016 (struts)	2x OASU0865001-ADJ (struts)	

\* kit prices include struts listed above plus the following parts \*

1x OASU1015001 (coil springs)

Coil spring seat spacers included with struts for height adjustment.

\* No spring seat spacer installed for trail.

### Expedition & Expedition HD

Lift front: up to 50mm (approx) height adjustable struts  
Suits vehicles with a steel bullbar, winch or heavy front loads

OASU911600E \$700 kit	OASU911600E-ADJ \$900 kit	
2x OASU0864016 (struts)	2x OASU0865001-ADJ (struts)	

\* kit prices include struts listed above plus the following parts \*

1x OASU1015003 (coil springs)

Coil spring seat spacers included with struts for height adjustment. Suits steel bullbar & medium front loads.

\* 10mm spring seat spacer installed for expedition.

\* 15mm spring seat spacer installed for expedition hd.

### ° Assembled Struts - Trail

Lift front: 50mm (@ approx 0-50kg load)  
Suits vehicles with oem bumper or light front loads

OASU931600T \$880 pr.	OASU931600T-ADJ \$1,080 pr.	
2x OASU391600T (each)	2x OASU391600T-ADJ (each)	

Assembled struts include: struts, coil springs & top mounts.

### ° Assembled Struts - Exped

Lift front: 50mm (@ approx 50-100kg load)  
Suits vehicles with a steel bullbar or medium front loads

OASU931600E \$880 pr.	OASU931600E-ADJ \$1,080 pr.	
2x OASU391600E (each)	2x OASU391600E-ADJ (each)	

Assembled struts include: struts, coil springs & top mounts.

### ° Assembled Struts - Exped HD

Lift front: 50mm (@ approx 100-150kg load)  
Suits vehicles with a steel bullbar & winch or heavy front loads

OASU931600H \$880 pr.	OASU931600H-ADJ \$1,080 pr.	
2x OASU391600H (each)	2x OASU391600H-ADJ (each)	

Assembled struts include: struts, coil springs & top mounts.

## RECOMMENDED OPTIONS & UPGRADES

<b>Jounce Stop Kit - Front</b>  OASU4210202 \$55 kit	Parts included: 2x OASU4210102 (jounce stops) Rubber, extended progressive rate (60mm / Multi-fit). Highly recommended to be installed in all vehicles with bullbars.
---	--

Lift heights are approximate and may vary depending on vehicle or product tolerances and load distribution.

# TOYOTA HILUX GENERATION 8

4x4 2015 +



## SUSPENSION KITS - REAR

**PERFORMANCE**

v

**ADJ. INTERNAL BYPASS**

v

Lift rear: 35mm (approx unladen)

Suits vehicles with light or occasional medium loads

### Trail - 35 Comfort

OASU921600C

**\$1,325 kit**

2x OASU0164024 (shocks)

OASU921600C-ADJ

**\$1,415 kit**

2x OASU0165024-ADJ (shocks)

\* kit prices include shock absorbers listed above plus the following parts \*

1x OASU210024K (bush kit)

4x OASU2362004 (u-bolts)

2x OASU1116005 (leaf springs)

2x OASU2500042 (pins)

2x OASU2400064 (shackles)

Rear bump stop kit "OASU4210004" highly recommended to reduce risk of component damage at full compression.  
(Adjustable Link Rod Kit required for SR5 models)

Lift rear: 50mm (approx unladen)

Suits vehicles with light or occasional medium loads

### Trail

OASU921600T

**\$1,265 kit**

2x OASU0164024 (shocks)

OASU921600T-ADJ

**\$1,355 kit**

2x OASU0165024-ADJ (shocks)

\* kit prices include shock absorbers listed above plus the following parts \*

1x OASU210024K (bush kit)

4x OASU2362002 (u-bolts)

2x OASU1116001 (leaf springs)

2x OASU2500042 (pins)

2x OASU2400064 (shackles)

Rear bump stop kit "OASU4210004" highly recommended to reduce risk of component damage at full compression.  
(Adjustable Link Rod Kit required for SR5 models)

Lift rear: 50mm (@ approx 200kg load)

Suits vehicles with constant medium or occasional heavy loads

### Expedition

OASU921600E

**\$1,305 kit**

2x OASU0164024 (shocks)

OASU921600E-ADJ

**\$1,395 kit**

2x OASU0165024-ADJ (shocks)

\* kit prices include shock absorbers listed above plus the following parts \*

1x OASU210024K (bush kit)

4x OASU2362002 (u-bolts)

2x OASU1116002 (leaf springs)

2x OASU2500042 (pins)

2x OASU2400064 (shackles)

Rear bump stop kit "OASU4210004" highly recommended to reduce risk of component damage at full compression.  
(Adjustable Link Rod Kit required for SR5 models)

Lift rear: 50mm (@ approx 400kg load)

Suits vehicles with constant heavy loads

### Expedition HD

OASU921600H

**\$1,385 kit**

2x OASU0164024 (shocks)

OASU921600H-ADJ

**\$1,475 kit**

2x OASU0165024-ADJ (shocks)

\* kit prices include shock absorbers listed above plus the following parts \*

1x OASU210024K (bush kit)

4x OASU2362005 (u-bolts)

2x OASU1116003 (leaf springs)

2x OASU2500042 (pins)

2x OASU2400064 (shackles)

Rear bump stop kit "OASU4210004" highly recommended to reduce risk of component damage at full compression.  
(Adjustable Link Rod Kit required for SR5 models)

Lift heights are approximate and may vary depending on vehicle & product tolerances and load distribution.

# TOYOTA HILUX GENERATION 8

4x4 2015 +



## SUSPENSION KITS - REAR

PERFORMANCE v	ADJ. INTERNAL BYPASS v	
------------------	---------------------------	--

### Expedition XHD

Lift rear: 50mm (@ approx 800kg load)  
Suits vehicles with constant heavy loads

OASU921600X \$1,485 kit	OASU921600X-ADJ \$1,575 kit	
2x OASU0164024 (shocks)	2x OASU0165024-ADJ (shocks)	

\* kit prices include shock absorbers listed above plus the following parts \*

1x OASU210024K (bush kit)	2x OASU1116004 (leaf springs)	2x OASU2500042 (pins)
4x OASU2362005 (u-bolts)		2x OASU2400064 (shackles)

Rear bump stop kit "OASU4210004" highly recommended to reduce risk of component damage at full compression.  
(Adjustable Link Rod Kit required for SR5 models)

## RECOMMENDED OPTIONS & UPGRADES

<b>Jounce Stop Kit - Rear</b>	Parts included:
OASU4210004 \$165 kit	2x OASU4210103 (u-bolt plate)   2x OASU4210104 (jounce stops) Rubber, extended progressive rate (110mm). Recommended to be installed in all vehicles with heavy rear loads.

Lift heights are approximate and may vary depending on vehicle & product tolerances and load distribution.



# TOYOTA HILUX GENERATION 8

4x4 2015 +



PRODUCT	PART NO.	DETAILS
Leaf Springs	OASU1116005	Trail - 35mm lift (approx unladen) - comfort 5 primary + 3 secondary
	OASU1116001	Trail - 50mm lift (approx unladen) 4 primary + 2 secondary
	OASU1116002	Expedition - 50mm lift (@ approx 200kg) 4 primary + 2 secondary
	OASU1116003	Expedition HD - 50mm lift (@ approx 400kg load) 5 primary + 3 secondary
	OASU1116004	Expedition XHD - 50mm lift (@ approx 800kg load) 6 primary + 3 secondary

Toyota Hilux Gen 8 Leaf Spring Deflection

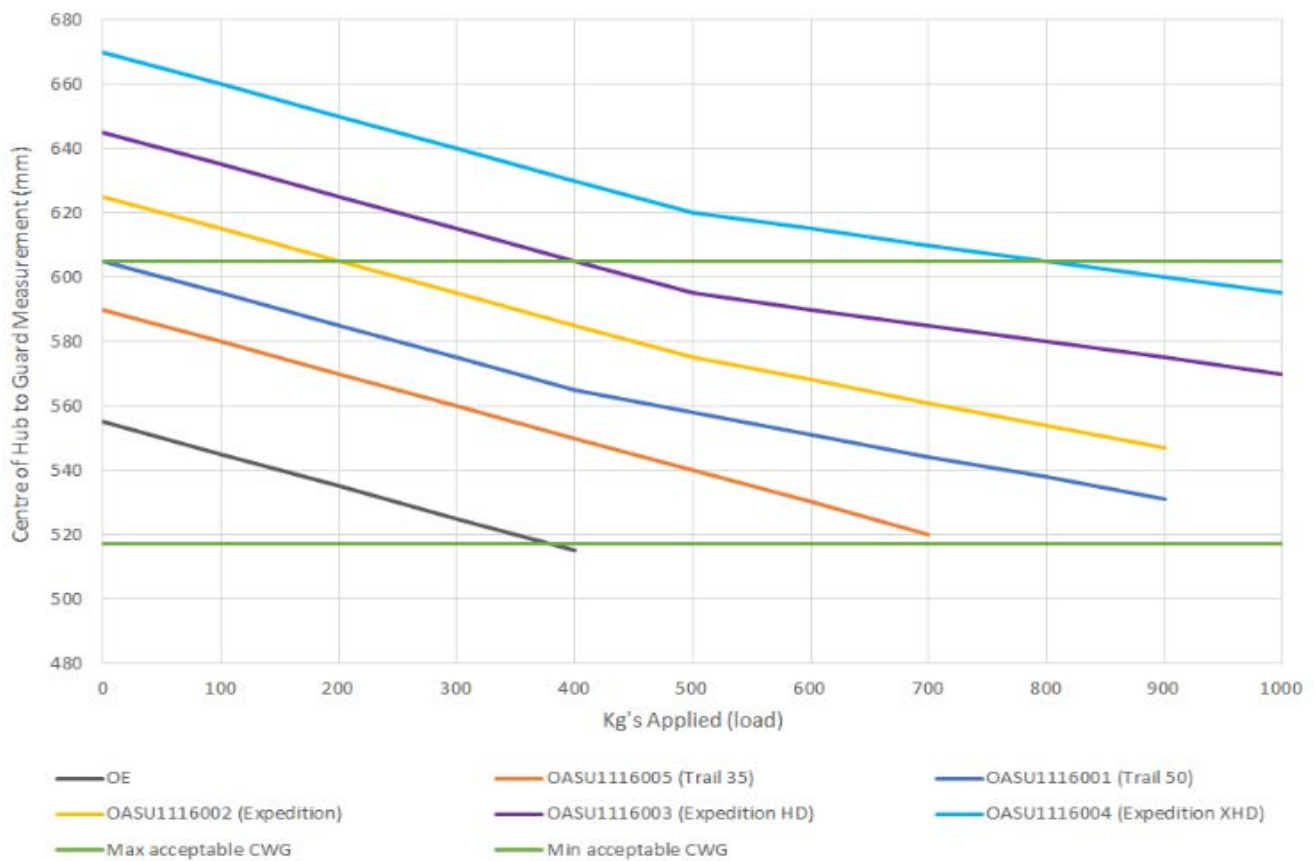

\* CWG (Centre Wheel to Guard) measured from centre of wheel to under-side of guard.

\* Max/Min Acceptable CWG are shown as a recommended guideline only.

\* CWG Heights approximate only, based on a standard dual cab style-side ute with no additional load.

Notes:

# TOYOTA FORTUNER GENERATION 3

2015 +



PRODUCT	PART NO.	QTY	DETAILS
<b>Struts</b> Max CWG: 560	OASU0864016 \$220 ea.	2	<b>Performance</b> - 60mm twin tube. Spacer ring adjustable height spring seat. Complete set of rubber bushes, washers & dust boot included.
	OASU0865001-ADJ \$320 ea.	2	<b>Adjustable Internal Bypass</b> - 65mm twin tube. Threaded variable height spring seat. Complete rubber bushes, washers & dust boot included.
<b>Shock Absorbers</b>	OASU0160007 \$175 ea.	2	<b>Performance</b> - 60mm twin tube. Complete set of rubber bushes & dust boot included.
	OASU0160007-ADJ \$220 ea.	2	<b>Adjustable Internal Bypass</b> - 60mm twin tube. Complete set of rubber bushes, brake line spacer kit & dust boot included.
<b>Coil Springs</b> (front, pair)	OASU1015001 \$260 pr.	1	Trail - 35mm lift (approx, height adj. struts to 50mm) <i>Suits vehicles with no front accessories. Springs seat spacers supplied with struts to adjust ride height.</i>
	OASU1015003 \$260 pr.	1	Expedition - up to 50mm lift (approx, adj. struts to 50mm) <i>Suits vehicles with bullbars and medium front loads. Springs seat spacers supplied with struts to adjust ride height.</i>
<b>Coil Springs</b> (rear, pair)	OASU1016004 \$260 pr.	1	Trail - 45mm lift (approx unladen)
	OASU1016006 \$260 pr.	1	Expedition - 50mm lift (@ approx 150kg load)
	OASU1016008 \$260 pr.	1	Expedition HD - 50mm lift (@ approx 300kg load)

## ACCESSORY ITEMS & CORRECTION COMPONENTS

<b>Bump Stops</b>	OASU4210102 \$27.50 ea.	2	Front - Rubber, extended progressive rate (60mm/M10x25mm)
<b>Centre Bearing Spacer Kit</b>	OASU3715002 \$45 kit	1	Supplied with all required washers, spacers & bolts. Recommended for all lifts to improve tailshaft angle and reduce vibrations.
<b>Strut Mount</b>	OASU0715002 \$80 ea.	2	Supplied with all required nuts, washers and bushes.

\* Ride heights approximates only, with no additional load, unless otherwise stated.

\* Outback Armour recommend that a minimum of two thirds of the original suspension travel in each direction is retained for optimal performance and durability.

## RECOMMENDED RECOVERY GEAR

<b>Snatch Strap</b>	OASS6T9M	1	Dynamic Snatch Strap - 6T/9M (2.00T - 3.00T)
<b>Recovery Kits</b>	OAQUICKSKST	1	Quick Snatch Kit - Small Truck
	OACOMPSKST	1	Comp Snatch Kit - Small Truck
	OAWINCHKIT	1	Winch Utility Kit

\*\* Complete range of Outback Armour recovery gear available at rear of this guide.

Notes:

# TOYOTA FORTUNER GENERATION 3

2015 +



## SUSPENSION KITS - FRONT

**PERFORMANCE**

v

**ADJ. INTERNAL BYPASS**

v

### Trail & Expedition

Lift front: 35mm (approx) height adjustable struts to 50mm  
Suits vehicles with oem bumper, bullbar or light front loads

OASU911603T \$700 kit	OASU911603T-ADJ \$900 kit	
2x OASU0864016 (struts)	2x OASU0865001-ADJ (struts)	

\* kit prices include struts listed above plus the following parts \*

1x OASU1015001 (coil springs)

Coil spring seat spacers included with struts for height adjustment.

### Expedition HD

Lift front: 50mm (@ approx 100kg load)  
Suits vehicles with a steel bullbar, winch or heavy front loads

OASU911603H \$700 kit	OASU911603H-ADJ \$900 kit	
2x OASU0864016 (struts)	2x OASU0865001-ADJ (struts)	

\* kit prices include struts listed above plus the following parts \*

1x OASU1015003 (coil springs)

Coil spring seat spacers included with struts for height adjustment.

### ° Assembled Struts - Trail

Lift front: 50mm (@ approx 0-50kg load)  
Suits vehicles with oem bumper or light front loads

OASU931603T \$880 pr.	OASU931603T-ADJ \$1,080 pr.	
2x OASU391603T (each)	2x OASU391603T-ADJ (each)	

Assembled struts include: struts, coil springs & top mounts.

### ° Assembled Struts - Exped

Lift front: 50mm (@ approx 50-100kg load)  
Suits vehicles with a steel bullbar or medium front loads

OASU931603E \$880 pr.	OASU931603E-ADJ \$1,080 pr.	
2x OASU391603E (each)	2x OASU391603E-ADJ (each)	

Assembled struts include: struts, coil springs & top mounts.

### ° Assembled Struts - Exped HD

Lift front: 50mm (@ approx 100-150kg load)  
Suits vehicles with a steel bullbar & winch or heavy front loads

OASU931603H \$880 pr.	OASU931603H-ADJ \$1,080 pr.	
2x OASU391603H (each)	2x OASU391603H-ADJ (each)	

Assembled struts include: struts, coil springs & top mounts.

## RECOMMENDED OPTIONS & UPGRADES

### Jounce Stop Kit - Front

OASU4210202  
\$55 kit

Parts included:

2x OASU4210102 (jounce stops)  
Rubber, extended progressive rate (60mm / M10x25mm).  
Highly recommended to be installed in all vehicles with bullbars.

Lift heights are approximate and may vary depending on vehicle or product tolerances and load distribution.

**TOYOTA FORTUNER GENERATION 3**

2015 +



**SUSPENSION KITS - REAR**

PERFORMANCE v	ADJ. INTERNAL BYPASS v	
------------------	---------------------------	--

**Trail**

Lift rear: 45mm (approx unladen)  
Suits vehicles with light or occasional medium loads

OASU921603T <b>\$655 kit</b>	OASU921603T-ADJ <b>\$745 kit</b>	
2x OASU0160007 (shocks)	2x OASU0160007-ADJ (shocks)	
* kit prices include shock absorbers listed above plus the following parts *		
1x OASU3715002 (c/b spacer kit)	1 pair OASU1016004 (coil springs)	

**Expedition**

Lift rear: 50mm (@ approx 150kg load)  
Suits vehicles with constant medium or occasional heavy loads

OASU921603E <b>\$655 kit</b>	OASU921603E-ADJ <b>\$745 kit</b>	
2x OASU0160007 (shocks)	2x OASU0160007-ADJ (shocks)	
* kit prices include shock absorbers listed above plus the following parts *		
1x OASU3715002 (c/b spacer kit)	1 pair OASU1016006 (coil springs)	

**Expedition HD**

Lift rear: 50mm (@ approx 300kg load)  
Suits vehicles with constant heavy loads

OASU921603H <b>\$655 kit</b>	OASU921603H-ADJ <b>\$745 kit</b>	
2x OASU0160007 (shocks)	2x OASU0160007-ADJ (shocks)	
* kit prices include shock absorbers listed above plus the following parts *		
1x OASU3715002 (c/b spacer kit)	1 pair OASU1016008 (coil springs)	

Lift heights are approximate and may vary depending on vehicle & product tolerances and load distribution.



**TOYOTA LANDCRUISER 76 SERIES**

2007 +



PRODUCT	PART NO.	QTY	DETAILS
<b>Shock Absorbers</b> (front)	OASU0160014 \$175 ea.	2	<b>Performance</b> - 60mm twin tube. Complete set of rubber bushes, washers included. Steel shroud. <i>Must be used with "Trail" coil spring OASU1070001.</i>
	OASU0165014-ADJ \$220 ea.	2	<b>Adjustable Internal Bypass</b> - 65mm twin tube. Complete set of rubber bushes, washers & dust boot included. <i>Must be used with "Trail" coil spring OASU1070001.</i>
	OASU0160031 (long travel) \$175 ea.	2	<b>Performance</b> - 60mm twin tube. Complete set of rubber bushes, washers included. Steel shroud. <i>Must be used with coil springs OASU1070002 or OASU1070003. Must use Front Sway Bar Spacer Kit OASU3322006.</i>
	OASU0165031-ADJ (long travel) \$220 ea.	2	<b>Adjustable Internal Bypass</b> - 65mm twin tube. Complete set of rubber bushes, washers & dust boot included. <i>Must be used with coil springs OASU1070002 or OASU1070003. Must use Front Sway Bar Spacer Kit OASU3322006.</i>
<b>Shock Absorbers</b> (rear)	OASU0160015 \$175 ea.	2	<b>Performance</b> - 60mm twin tube. Complete set of rubber bushes included. Steel shroud. <i>Shock absorber length suits vehicles with rear sway bars or airbags (shorter length than the OASU0160032 part).</i>
	OASU0165015-ADJ \$220 ea.	2	<b>Adjustable Internal Bypass</b> - 65mm twin tube. Complete set of rubber bushes, washers & dust boot included. <i>Shock absorber length suits vehicles with rear sway bars or airbags (shorter length than the OASU0160032 part).</i>
	OASU0160032 (longer travel) \$175 ea.	2	<b>Performance</b> - 60mm twin tube. Complete set of rubber bushes included. Steel shroud. <i>Longer travel shock absorber. Use extended sway bar links OASU3322007 on vehicles with rear sway bars.</i>
	OASU0165032-ADJ (longer travel) \$220 ea.	2	<b>Adjustable Internal Bypass</b> - 65mm twin tube. Complete set of rubber bushes, washers & dust boot included. <i>Longer travel shock absorber. Use extended sway bar links OASU3322007 on vehicles with rear sway bars.</i>
<b>Steering Damper</b>	OASU0954001 \$150 ea.	1	51mm twin tube foam cell construction. Complete set of bushes and tapered pins included. Steel shroud.
<b>Coil Springs</b> (pair)	OASU1070001 \$260 pr.	1	Trail - 25mm lift (approx unladen) <i>Suits front height correction for bar &amp; winch with oem rear leaf.</i>
	OASU1070002 \$260 pr.	1	Expedition - 50mm lift (approx unladen) <i>Suits lift with oem bumper or bullbar.</i>
	OASU1070003 \$325 pr.	1	Expedition HD - 50mm lift (@ approx 100kg load) <i>Suits lift with heavy steel bullbar and winch combination.</i>
<b>Leaf Springs</b>	OASU1176001 \$400 ea.	2	Trail - 50mm lift (approx unladen) <i>5 primary + 3 secondary</i>
	OASU1176002 \$450 ea.	2	Expedition - 50mm lift (@ approx 200kg load) <i>6 primary + 3 secondary</i>
	OASU1176003 \$485 ea.	2	Expedition HD - 50mm lift (@ approx 500kg load) <i>6 primary + 3 secondary</i>
<i>** Refer leaf spring graph following for approximate deflections under load.</i>			
<b>Leaf Spring Bush Kit</b>	OASU210025K \$200 kit	1	12 polyurethane bushes. <i>Must be used with Outback Armour shackles &amp; pins.</i>

**TOYOTA LANDCRUISER 76 SERIES**

2007 +



PRODUCT	PART NO.	QTY	DETAILS
U-bolts	OASU2384001 \$15 ea.	4	Suits leaf springs: OASU1176001 M14 x 84 ID (RND) x 215 L
	OASU2384002 \$15 ea.	4	Suits leaf springs: OASU1176002 M14 x 84 ID (RND) x 235 L
<i>** All u-bolts hardened steel, rolled threads, deep nuts &amp; spring washers.</i>			
Pins	OASU2500043 \$35 ea.	2	Greasable, hardened steel Must be used with Outback Armour bush kit.
Shackles	OASU2400056 \$50 ea.	2	Greasable, hardened steel pins. Must be used with Outback Armour bush kit.

**ACCESSORY ITEMS & CORRECTION COMPONENTS**

Caster Correction Bush Kits	OASU210100K \$200 kit	1	Rubber - 2 degree caster increase (set of 4).
Correction Components	OASU3322007 \$40 each	2	Rear Sway Bar Link 20mm longer than oem. Suits vehicles with rear sway bars and longer travel shock absorbers OASU0160032. 2x required.
	OASU3770001 \$5 kit	1	Brake Bias Spacer Kit Corrects proportioning valve position for correct braking application at lifted suspension heights.
	OASU3770002 \$5 kit	1	Handbrake Cable Bracket Kit Provides extra clearance between the left rear shock absorber and the handbrake cable.
	OASU3770005 \$30 kit	1	Front ABS Bracket Kit Repositions front ABS lines to avoid stretching when articulating
	OASU3322006 \$20 kit	1	Front Sway Bar Spacer Kit Eliminates contact between front drive shaft and sway bar at full droop. ** This spacer kit must be used with shock absorber part number OASU0160031.
Coil Spring Spacers	OASU2130217 \$35 ea.	2	Front - 10mm, polyurethane
	OASU2130216 \$105 ea.	2	Front - 30mm, polyurethane
Bump Stops	OASU3770003 \$15 kit	1	Front Coil Spring Jounce Stop Spacer Kit Spaces the bump stop down to provide protection for shock absorbers from damage at full compression..
	OASU3770004 \$25 kit	1	Front Chassis Bump Stop Spacer Kit Spaces the bump stop down to provide protection for shock absorbers from damage at full compression..
	OASU4270004 \$185 pr.	1	Rear - Rubber, extended progressive rate (160mm)

\* Ride heights approximates only, with no additional load, unless otherwise stated.

\* Outback Armour recommend that a minimum of two thirds of the original suspension travel in each direction is retained.



# TOYOTA LANDCRUISER 76 SERIES

2007 +



## SUSPENSION KITS - FRONT

PERFORMANCE v	ADJ. INTERNAL BYPASS v	
------------------	---------------------------	--

**Trail** Lift front: 25mm (approx unladen)  
Suits vehicles with oem bumper or light front loads

OASU917600T <b>\$760 kit</b>	OASU917600T-ADJ <b>\$850 kit</b>	
2x OASU0160014 (shocks)	2x OASU0165014-ADJ (shocks)	

\* kit prices include shock absorbers listed above plus the following parts \*

1 pair OASU1070001 (coil springs)    1x OASU0954001 (steering damper)

Front bump stop spacer kit "OASU3770003" highly recommended to reduce risk of component damage at full compression.

**Expedition** Lift front: 50mm (approx unladen)  
Suits vehicles with a steel bullbar or medium front loads

OASU917600E <b>\$810 kit</b>	OASU917600E-ADJ <b>\$900 kit</b>	
2x OASU0160031 (shocks)	2x OASU0165031-ADJ (shocks)	

\* kit prices include shock absorbers listed above plus the following parts \*

1 pair OASU1070002 (coil springs)    1x OASU3322006 (sway bar spr.)    1x OASU3770005 (ABS bracket kit)  
1x OASU0954001 (steering damper)

Front bump stop spacer kits "OASU3770003" & "OASU3770004" highly recommended to reduce risk of component damage at full compression.

**Expedition HD** Lift front: 50mm (@ approx 100kg load)  
Suits vehicles with a steel bullbar, winch or heavy front loads

OASU917600H <b>\$875 kit</b>	OASU917600H-ADJ <b>\$965 kit</b>	
2x OASU0160031 (shocks)	2x OASU0165031-ADJ (shocks)	

\* kit prices include shock absorbers listed above plus the following parts \*

1 pair OASU1070003 (coil springs)    1x OASU3322006 (sway bar spr.)    1x OASU3770005 (ABS bracket kit)  
1x OASU0954001 (steering damper)

Front bump stop spacer kits "OASU3770003" & "OASU3770004" highly recommended to reduce risk of component damage at full compression.

### RECOMMENDED OPTIONS & UPGRADES

<b>Caster Correction Kit</b> OASU210100K <b>\$200 kit</b>	Parts included: 1x OASU210100K (2 degree caster correction kit) Includes: 4x rubber bushes with fitting instructions.
<b>Front Coil Spring Jounce Stop Spacer Kit</b> OASU3770003 <b>\$15 kit</b>	Parts included: 2x Nylon spacers and bolt kit. Includes: 2x 20mm spacers with fitting instructions.

Lift heights are approximate and may vary depending on vehicle or product tolerances and load distribution.



# TOYOTA LANDCRUISER 76 SERIES

2007 +



## SUSPENSION KITS - REAR

PERFORMANCE v	ADJ. INTERNAL BYPASS v	
------------------	---------------------------	--

**Trail** Lift rear: 50mm (approx unladen)  
Suits vehicles with light or occasional medium loads

OASU927600T <b>\$1,590 kit</b>	OASU927600T-ADJ <b>\$1,680 kit</b>	
2x OASU0160032 (shocks)	2x OASU0165032-ADJ (shocks)	

\* kit prices include shock absorbers listed above plus the following parts \*

1x OASU210025K (bush kit)	2x OASU1176001 (leaf springs)	2x OASU2500043 (pins)
4x OASU2384001 (u-bolts)	1x OASU3770001 (brake bias kit)	2x OASU2400056 (shackles)
	1x OASU3770002 (handbrake kit)	

Rear bump stop kit "OASU4270004" highly recommended to reduce risk of component damage at full compression.  
Longer travel shock absorber. Use extended sway bar links OASU3322007 on vehicles with rear sway bars.

**Expedition** Lift rear: 50mm (@ approx 200kg load)  
Suits vehicles with constant medium or occasional heavy loads

OASU927600E <b>\$1,690 kit</b>	OASU927600E-ADJ <b>\$1,780 kit</b>	
2x OASU0160032 (shocks)	2x OASU0165032-ADJ (shocks)	

\* kit prices include shock absorbers listed above plus the following parts \*

1x OASU210025K (bush kit)	2x OASU1176002 (leaf springs)	2x OASU2500043 (pins)
4x OASU2384002 (u-bolts)	1x OASU3770001 (brake bias kit)	2x OASU2400056 (shackles)
	1x OASU3770002 (handbrake kit)	

Rear bump stop kit "OASU4270004" highly recommended to reduce risk of component damage at full compression.  
Longer travel shock absorber. Use extended sway bar links OASU3322007 on vehicles with rear sway bars.

**Expedition HD** Lift rear: 50mm (@ approx 500kg load)  
Suits vehicles with constant heavy loads

OASU927600H <b>\$1,760 kit</b>	OASU927600H-ADJ <b>\$1,850 kit</b>	
2x OASU0160032 (shocks)	2x OASU0165032-ADJ (shocks)	

\* kit prices include shock absorbers listed above plus the following parts \*

1x OASU210025K (bush kit)	2x OASU1176003 (leaf springs)	2x OASU2500043 (pins)
4x OASU2384005 (u-bolts)	1x OASU3770001 (brake bias kit)	2x OASU2400056 (shackles)
	1x OASU3770002 (handbrake kit)	

Rear bump stop kit "OASU4270004" highly recommended to reduce risk of component damage at full compression.  
Longer travel shock absorber. Use extended sway bar links OASU3322007 on vehicles with rear sway bars.

## RECOMMENDED OPTIONS & UPGRADES

<b>Jounce Stop Kit - Rear</b>	Parts included:
OASU4270004 <b>\$185 kit</b>	2x (160mm jounce stops)
	Rubber, extended progressive rate (160mm, bonded brackets).
	Highly recommended for all vehicles with heavy rear loads.

Lift heights are approximate and may vary depending on vehicle & product tolerances and load distribution.

# TOYOTA LANDCRUISER 76 SERIES

2007 +



PRODUCT	PART NO.	DETAILS
Leaf Springs	OASU1176001	Trail - 50mm lift (approx unladen) 5 primary + 3 secondary
	OASU1176002	Expedition - 50mm lift (@ approx 200kg load) 6 primary + 3 secondary
	OASU1176003	Expedition HD - 50mm lift (@ approx 500kg load) 6 primary + 3 secondary

Toyota Landcruiser 76 Series Leaf Spring Deflection

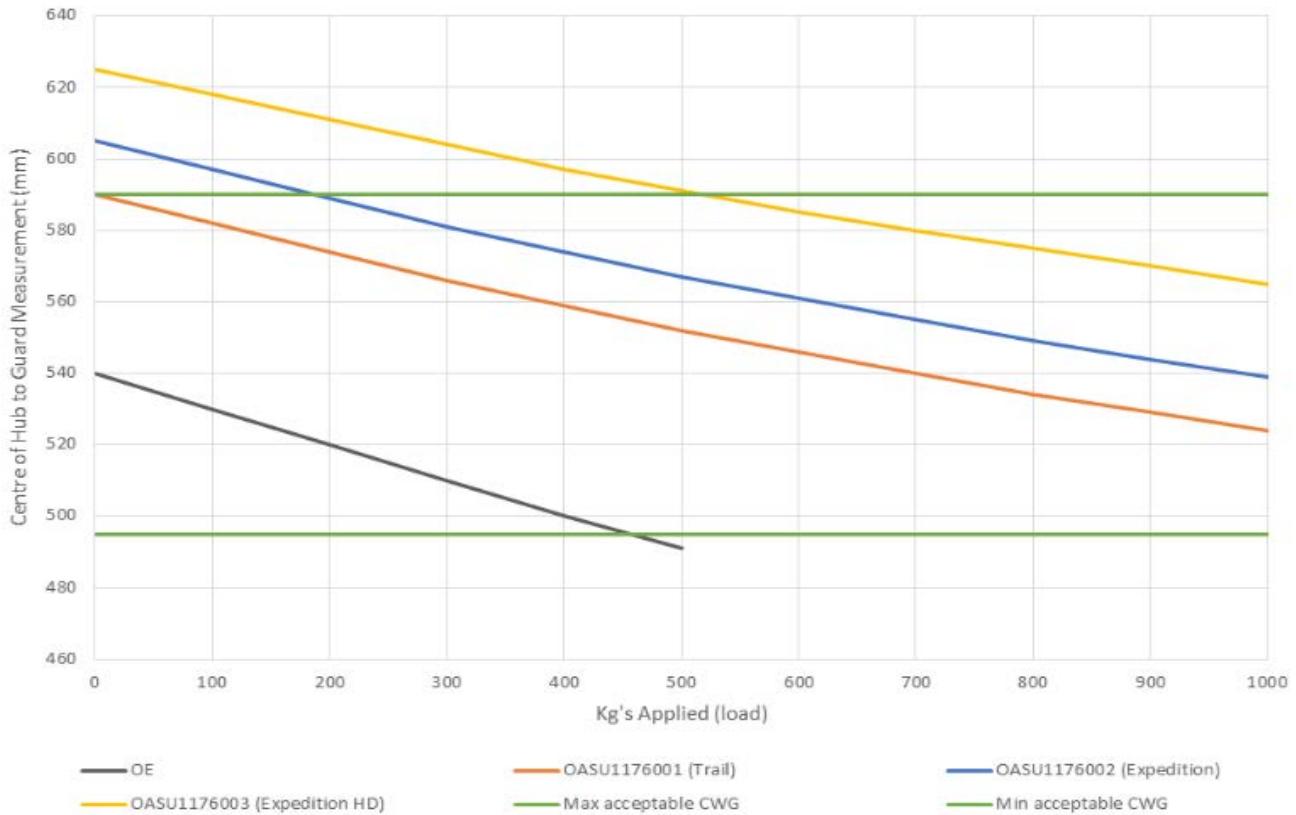

\* CWG (Centre Wheel to Guard) measured from centre of wheel to under-side of guard.

\* Max/Min Acceptable CWG are shown as a recommended guideline only.

\* CWG Heights approximate only, based on a standard dual cab style-side ute with no additional load.

Notes:



**TOYOTA LANDCRUISER 78 SERIES (6 CYL PRE 2007)**

2000 - 2006



PRODUCT	PART NO.	QTY	DETAILS
<b>Shock Absorbers</b> (front)	OASU0160014 \$175 ea.	2	<b>Performance</b> - 60mm twin tube. Complete set of rubber bushes, washers included. Steel shroud. <i>Must be used with "Trail" coil spring OASU1070001.</i>
	OASU0165014-ADJ \$220 ea.	2	<b>Adjustable Internal Bypass</b> - 65mm twin tube. Complete set of rubber bushes, washers & dust boot included. <i>Must be used with "Trail" coil spring OASU1070001.</i>
	OASU0160031 (long travel) \$175 ea.	2	<b>Performance</b> - 60mm twin tube. Complete set of rubber bushes, washers included. Steel shroud. <i>Must be used with coil springs OASU1070002 or OASU1070003. Must use Front Sway Bar Spacer Kit OASU3322006.</i>
	OASU0165031-ADJ (long travel) \$220 ea.	2	<b>Adjustable Internal Bypass</b> - 65mm twin tube. Complete set of rubber bushes, washers & dust boot included. <i>Must be used with coil springs OASU1070002 or OASU1070003. Must use Front Sway Bar Spacer Kit OASU3322006.</i>
<b>Shock Absorbers</b> (rear)	OASU0160015 \$175 ea.	2	<b>Performance</b> - 60mm twin tube. Complete set of rubber bushes included. Steel shroud. <i>Shock absorber length suits vehicles with rear sway bars or airbags (shorter length than the OASU0160032 part).</i>
	OASU0165015-ADJ \$220 ea.	2	<b>Adjustable Internal Bypass</b> - 65mm twin tube. Complete set of rubber bushes, washers & dust boot included. <i>Shock absorber length suits vehicles with rear sway bars or airbags (shorter length than the OASU0160032 part).</i>
	OASU0160032 (longer travel) \$175 ea.	2	<b>Performance</b> - 60mm twin tube. Complete set of rubber bushes included. Steel shroud. <i>Longer travel shock absorber. Use extended sway bar links OASU3322007 on vehicles with rear sway bars.</i>
	OASU0165032-ADJ (longer travel) \$220 ea.	2	<b>Adjustable Internal Bypass</b> - 65mm twin tube. Complete set of rubber bushes, washers & dust boot included. <i>Longer travel shock absorber. Use extended sway bar links OASU3322007 on vehicles with rear sway bars.</i>
<b>Steering Damper</b>	OASU0954002 \$150 ea.	1	51mm twin tube foam cell construction. Complete set of bushes and tapered pins included. Steel shroud. <i>Suits: TLC78 Series 6CYL models up to 2007.</i>
<b>Coil Springs</b> (pair)	OASU1070001 \$260 pr.	1	Trail - 25mm lift (approx unladen) <i>Suits front height correction for bar &amp; winch with oem rear leaf.</i>
	OASU1070002 \$260 pr.	1	Expedition - 50mm lift (approx unladen) <i>Suits lift with oem bumper or bullbar.</i>
	OASU1070003 \$325 pr.	1	Expedition HD - 50mm lift (@ approx 100kg load) <i>Suits lift with heavy steel bullbar and winch combination.</i>
<b>Leaf Springs</b>	OASU1178012 \$575 ea.	2	Comfort - 40mm lift (approx unladen) <i>8 primary + 2 secondary</i>
	OASU1178001 \$575 ea.	2	Trail - 50mm lift (approx unladen) <i>8 primary + 2 secondary</i>
	OASU1178002 \$625 ea.	2	Expedition - 50mm lift (@ approx 400kg load) <i>8 primary + 2 secondary</i>
	OASU1178010 \$650 ea.	2	Expedition HD - 50mm lift (@ approx 600kg load) <i>8 primary + 2 secondary</i>
<i>** Refer leaf spring graph following for approximate deflections under load.</i>			

**TOYOTA LANDCRUISER 78 SERIES (6 CYL PRE 2007)**

2000 - 2006



PRODUCT	PART NO.	QTY	DETAILS
<b>Leaf Spring Bush Kit</b>	OASU210025K \$200 kit	1	12 polyurethane bushes. <i>Must be used with Outback Armour shackles &amp; pins.</i>
<b>U-bolts</b>	OASU2384002 \$15 ea.	4	Suits leaf springs: OASU1178001 & OASU1178012 M14 x 84 ID (RND) x 235 L
	OASU2384004 \$15 ea.	4	Suits leaf springs: OASU1178002 & OASU1178010 M14 x 84 ID (RND) x 245 L
<i>** All u-bolts hardened steel, rolled threads, deep nuts &amp; spring washers.</i>			
<b>Pins</b>	OASU2500043 \$35 ea.	2	Greasable, hardened steel <i>Must be used with Outback Armour bush kit.</i>
<b>Shackles</b>	OASU2400056 \$50 ea.	2	Greasable, hardened steel pins. <i>Must be used with Outback Armour bush kit.</i>

**ACCESSORY ITEMS & CORRECTION COMPONENTS**

<b>Caster Correction Bush Kits</b>	OASU210100K \$200 kit	1	Rubber - 2 degree caster increase (set of 4).
<b>Correction Components</b>	OASU3322007 \$40 each	2	Rear Sway Bar Link <i>20mm longer than oem. Suits vehicles with rear sway bars and longer travel shock absorbers OASU0160032. 2x required.</i>
	OASU3770001 \$5 kit	1	Brake Bias Spacer Kit <i>Corrects proportioning valve position for correct braking application at lifted suspension heights.</i>
	OASU3770002 \$5 kit	1	Handbrake Cable Bracket Kit <i>Provides extra clearance between the left rear shock absorber and the handbrake cable.</i>
	OASU3770005 \$30 kit	1	Front ABS Bracket Kit <i>Repositions front ABS lines to avoid stretching when articulating</i>
	OASU3322006 \$20 kit	1	Front Sway Bar Spacer Kit <i>Eliminates front drive shaft and sway bar contact. ** This spacer kit must be used with shock absorber part number OASU0160031.</i>
<b>Coil Spring Spacers</b>	OASU2130217 \$35 ea.	2	Front - 10mm, polyurethane
	OASU2130216 \$105 ea.	2	Front - 30mm, polyurethane
<b>Bump Stops</b>	OASU3770003 \$15 kit	1	Front Coil Spring Jounce Stop Spacer Kit <i>Spaces the bump stop down to provide protection for shock absorbers from damage at full compression..</i>
	OASU3770004 \$25 kit	1	Front Chassis Bump Stop Spacer Kit <i>Spaces the bump stop down to provide protection for shock absorbers from damage at full compression..</i>
	OASU4270004 \$185 pr.	1	Rubber, extended progressive rate (160mm, bonded brackets)

# TOYOTA LANDCRUISER 78 SERIES (6 CYL PRE 2007)

2000 - 2006



## SUSPENSION KITS - FRONT

PERFORMANCE v	ADJ. INTERNAL BYPASS v	
------------------	---------------------------	--

**Trail Kit B (6CYL pre 2007)** Lift front: 25mm (approx unladen)  
Suits vehicles with oem bumper or light front loads

OASU91780TB <b>\$760 kit</b>	OASU91780TB-ADJ <b>\$850 kit</b>	
2x OASU0160014 (shocks)	2x OASU0165014-ADJ (shocks)	

\* kit prices include shock absorbers listed above plus the following parts \*

1 pair OASU1070001 (coil springs)    1x OASU0954002 (steering damper)

Front bump stop spacer kit "OASU3770003" highly recommended to reduce risk of component damage at full compression. Suits TLC78 Series 6CYL models up to 2007.

**Expedition Kit B (6CYL pre 2007)** Lift front: 50mm (approx unladen)  
Suits vehicles with a steel bullbar or medium front loads

OASU91780EB <b>\$810 kit</b>	OASU91780EB-ADJ <b>\$900 kit</b>	
2x OASU0160031 (shocks)	2x OASU0165031-ADJ (shocks)	

\* kit prices include shock absorbers listed above plus the following parts \*

1 pair OASU1070002 (coil springs)    1x OASU3322006 (sway bar spr.)    1x OASU3770005 (ABS bracket kit)  
1x OASU0954002 (steering damper)

Front bump stop spacer kits "OASU3770003" & "OASU3770004" highly recommended to reduce risk of component damage at full compression. Suits TLC78 Series 6CYL models up to 2007.

**Exped HD Kit B (6CYL pre 2007)** Lift front: 50mm (@ approx 100kg load)  
Suits vehicles with a steel bullbar, winch or heavy front loads

OASU91780HB <b>\$875 kit</b>	OASU91780HB-ADJ <b>\$965 kit</b>	
2x OASU0160031 (shocks)	2x OASU0165031-ADJ (shocks)	

\* kit prices include shock absorbers listed above plus the following parts \*

1 pair OASU1070003 (coil springs)    1x OASU3322006 (sway bar spr.)    1x OASU3770005 (ABS bracket kit)  
1x OASU0954002 (steering damper)

Front bump stop spacer kits "OASU3770003" & "OASU3770004" highly recommended to reduce risk of component damage at full compression. Suits TLC78 Series 6CYL models up to 2007.

## RECOMMENDED OPTIONS & UPGRADES

<b>Caster Correction Kit</b> OASU210100K <b>\$200 kit</b>	Parts included: 1x OASU210100K (2 degree caster correction kit) Includes: 4x rubber bushes with fitting instructions.
<b>Front Coil Spring Jounce Stop Spacer Kit</b> OASU3770003 <b>\$15 kit</b>	Parts included: 2x Nylon spacers and bolt kit. Includes: 2x 20mm spacers with fitting instructions.

Lift heights are approximate and may vary depending on vehicle or product tolerances and load distribution.

# TOYOTA LANDCRUISER 78 SERIES (6 CYL PRE 2007)

2000 - 2006



## SUSPENSION KITS - REAR

**PERFORMANCE**

v

**ADJ. INTERNAL BYPASS**

v

### Comfort

Lift rear: 40mm (approx unladen), comfort spring rate  
Suits vehicles with light or occasional medium loads

OASU927800C

**\$1,940 kit**

2x OASU0160032 (shocks)

OASU927800C-ADJ

**\$2,030 kit**

2x OASU0165032-ADJ (shocks)

\* kit prices include shock absorbers listed above plus the following parts \*

1x OASU210025K (bush kit)

4x OASU2384002 (u-bolts)

2x OASU1178012 (leaf springs)

1x OASU3770001 (brake bias kit)

1x OASU3770002 (handbrake kit)

2x OASU2500043 (pins)

2x OASU2400056 (shackles)

Rear bump stop kit "OASU4270004" highly recommended to reduce risk of component damage at full compression.  
Longer travel shock absorber. Use extended sway bar links OASU3322007 on vehicles with rear sway bars.

### Trail

Lift rear: 50mm (approx unladen)  
Suits vehicles with light or occasional medium loads

OASU927800T

**\$1,940 kit**

2x OASU0160032 (shocks)

OASU927800T-ADJ

**\$2,030 kit**

2x OASU0165032-ADJ (shocks)

\* kit prices include shock absorbers listed above plus the following parts \*

1x OASU210025K (bush kit)

4x OASU2384002 (u-bolts)

2x OASU1178001 (leaf springs)

1x OASU3770001 (brake bias kit)

1x OASU3770002 (handbrake kit)

2x OASU2500043 (pins)

2x OASU2400056 (shackles)

Rear bump stop kit "OASU4270004" highly recommended to reduce risk of component damage at full compression.  
Longer travel shock absorber. Use extended sway bar links OASU3322007 on vehicles with rear sway bars.

### Expedition

Lift rear: 50mm (@ approx 400kg load)  
Suits vehicles with constant medium or occasional heavy loads

OASU927800E

**\$2,040 kit**

2x OASU0160032 (shocks)

OASU927800E-ADJ

**\$2,130 kit**

2x OASU0165032-ADJ (shocks)

\* kit prices include shock absorbers listed above plus the following parts \*

1x OASU210025K (bush kit)

4x OASU2384004 (u-bolts)

2x OASU1178002 (leaf springs)

1x OASU3770001 (brake bias kit)

1x OASU3770002 (handbrake kit)

2x OASU2500043 (pins)

2x OASU2400056 (shackles)

Rear bump stop kit "OASU4270004" highly recommended to reduce risk of component damage at full compression.  
Longer travel shock absorber. Use extended sway bar links OASU3322007 on vehicles with rear sway bars.

Lift heights are approximate and may vary depending on vehicle & product tolerances and load distribution.



**TOYOTA LANDCRUISER 78 SERIES (6 CYL PRE 2007)**

2000 - 2006



**SUSPENSION KITS - REAR**

PERFORMANCE v	ADJ. INTERNAL BYPASS v	
------------------	---------------------------	--

**Expedition HD**

Lift: 50mm rear (@ approx 600kg load)  
Suits vehicles with constant heavy loads

OASU927800H <b>\$2,090 kit</b>	OASU927800H-ADJ <b>\$2,180 kit</b>	
2x OASU0160032 (shocks)	2x OASU0165032-ADJ (shocks)	

\* kit prices include shock absorbers listed above plus the following parts \*

1x OASU210025K (bush kit)	2x OASU1178010 (leaf springs)	2x OASU2500043 (pins)
4x OASU2384004 (u-bolts)	1x OASU3770001 (brake bias kit)	2x OASU2400056 (shackles)
	1x OASU3770002 (handbrake kit)	

Rear bump stop kit "OASU4270004" highly recommended to reduce risk of component damage at full compression.  
Longer travel shock absorber. Use extended sway bar links OASU3322007 on vehicles with rear sway bars.

**RECOMMENDED OPTIONS & UPGRADES**

<b>Jounce Stop Kit - Rear</b>  OASU4270004 <b>\$185 kit</b>	Parts included: 2x (160mm jounce stops) Rubber, extended progressive rate (160mm, bonded brackets). Highly recommended for all vehicles with heavy rear loads.
--	---

Lift heights are approximate and may vary depending on vehicle & product tolerances and load distribution.



**TOYOTA LANDCRUISER 78 SERIES (6 CYL PRE 2007)**

2000 - 2006



PRODUCT	PART NO.	DETAILS
<b>Leaf Springs</b>	OASU1178012	Trail - 40mm lift comfort (approx unladen) <i>8 primary + 2 secondary</i>
	OASU1178001	Trail - 50mm lift (approx unladen) <i>8 primary + 2 secondary</i>
	OASU1178002	Expedition - 50mm lift (@ approx 400kg load) <i>8 primary + 2 secondary</i>
	OASU1178010	Expedition HD - 50mm lift (@ approx 600kg load) <i>8 primary + 2 secondary</i>

Toyota Landcruiser 78 Series Leaf Spring Deflection

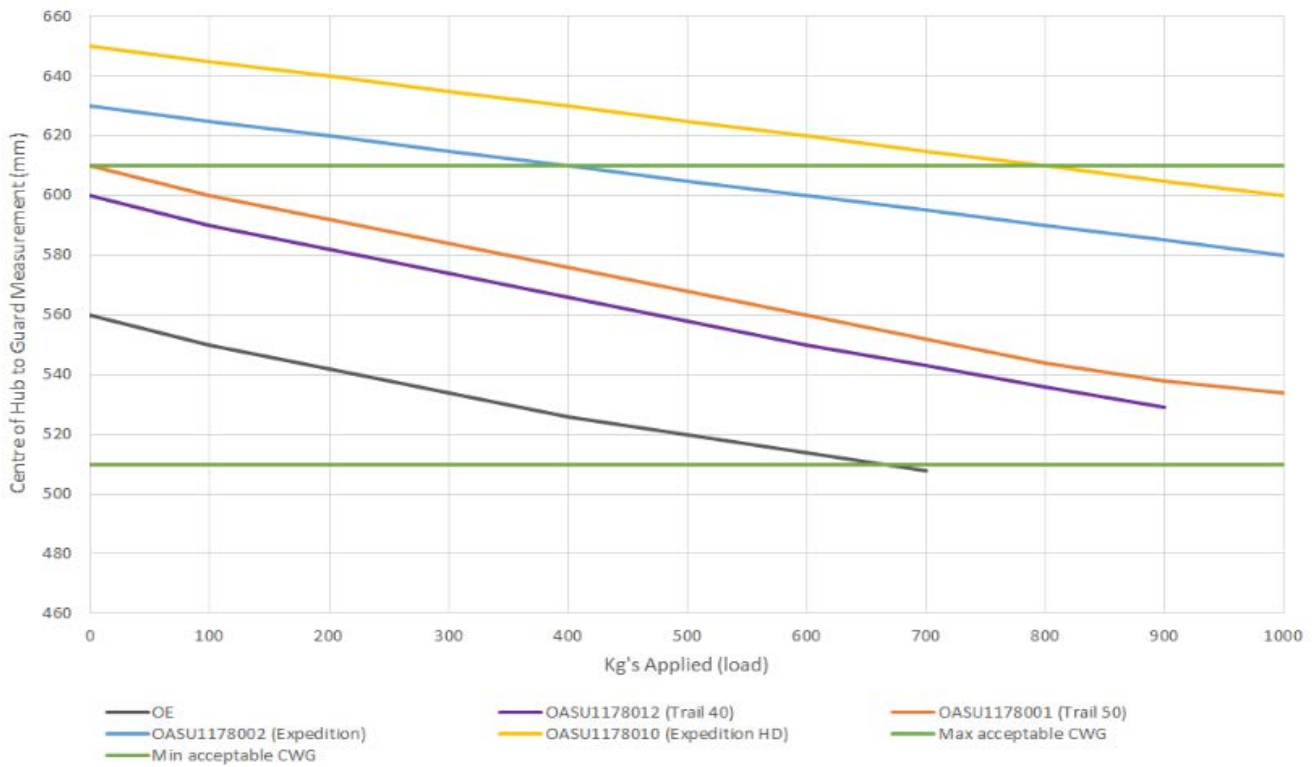

\* CWG (Centre Wheel to Guard) measured from centre of wheel to under-side of guard.

\* Max/Min Acceptable CWG are shown as a recommended guideline only.

\* CWG Heights approximate only, based on a standard dual cab style-side ute with no additional load.

Notes:

**TOYOTA LANDCRUISER 78 SERIES (V8 2007+)**

2007 +



PRODUCT	PART NO.	QTY	DETAILS
<b>Shock Absorbers</b> (front)	OASU0160014 \$175 ea.	2	<b>Performance</b> - 60mm twin tube. Complete set of rubber bushes, washers included. Steel shroud. <i>Must be used with "Trail" coil spring OASU1070001.</i>
	OASU0165014-ADJ \$220 ea.	2	<b>Adjustable Internal Bypass</b> - 65mm twin tube. Complete set of rubber bushes, washers & dust boot included. <i>Must be used with "Trail" coil spring OASU1070001.</i>
	OASU0160031 (long travel) \$175 ea.	2	<b>Performance</b> - 60mm twin tube. Complete set of rubber bushes, washers included. Steel shroud. <i>Must be used with coil springs OASU1070002 or OASU1070003. Must use Front Sway Bar Spacer Kit OASU3322006.</i>
	OASU0165031-ADJ (long travel) \$220 ea.	2	<b>Adjustable Internal Bypass</b> - 65mm twin tube. Complete set of rubber bushes, washers & dust boot included. <i>Must be used with coil springs OASU1070002 or OASU1070003. Must use Front Sway Bar Spacer Kit OASU3322006.</i>
<b>Shock Absorbers</b> (rear)	OASU0160015 \$175 ea.	2	<b>Performance</b> - 60mm twin tube. Complete set of rubber bushes included. Steel shroud. <i>Shock absorber length suits vehicles with rear sway bars or airbags (shorter length than the OASU0160032 part).</i>
	OASU0165015-ADJ \$220 ea.	2	<b>Adjustable Internal Bypass</b> - 65mm twin tube. Complete set of rubber bushes, washers & dust boot included. <i>Shock absorber length suits vehicles with rear sway bars or airbags (shorter length than the OASU0160032 part).</i>
	OASU0160032 (longer travel) \$175 ea.	2	<b>Performance</b> - 60mm twin tube. Complete set of rubber bushes included. Steel shroud. <i>Longer travel shock absorber. Use extended sway bar links OASU3322007 on vehicles with rear sway bars.</i>
	OASU0165032-ADJ (longer travel) \$220 ea.	2	<b>Adjustable Internal Bypass</b> - 65mm twin tube. Complete set of rubber bushes, washers & dust boot included. <i>Longer travel shock absorber. Use extended sway bar links OASU3322007 on vehicles with rear sway bars.</i>
<b>Steering Damper</b>	OASU0954001 \$150 ea.	1	51mm twin tube foam cell construction. Complete set of bushes and tapered pins included. Steel shroud. <i>Suits: TLC78 Series V8 models &amp; 2007+ 6CYL models (overseas).</i>
<b>Coil Springs</b> (pair)	OASU1070001 \$260 pr.	1	Trail - 25mm lift (approx unladen) <i>Suits front height correction for bar &amp; winch with oem rear leaf.</i>
	OASU1070002 \$260 pr.	1	Expedition - 50mm lift (approx unladen) <i>Suits lift with oem bumper or bullbar.</i>
	OASU1070003 \$325 pr.	1	Expedition HD - 50mm lift (@ approx 100kg load) <i>Suits lift with heavy steel bullbar and winch combination.</i>
<b>Leaf Springs</b>	OASU1178012 \$575 ea.	2	Comfort - 40mm lift (approx unladen) <i>8 primary + 2 secondary</i>
	OASU1178001 \$575 ea.	2	Trail - 50mm lift (approx unladen) <i>8 primary + 2 secondary</i>
	OASU1178002 \$625 ea.	2	Expedition - 50mm lift (@ approx 400kg load) <i>8 primary + 2 secondary</i>
	OASU1178010 \$650 ea.	2	Expedition HD - 50mm lift (@ approx 600kg load) <i>8 primary + 2 secondary</i>

*\*\* Refer leaf spring graph following for approximate deflections under load.*

**TOYOTA LANDCRUISER 78 SERIES (V8 2007+)**

2007 +



PRODUCT	PART NO.	QTY	DETAILS
<b>Leaf Spring Bush Kit</b>	OASU210025K \$200 kit	1	12 polyurethane bushes. <i>Must be used with Outback Armour shackles &amp; pins.</i>
<b>U-bolts</b>	OASU2384002 \$15 ea.	4	Suits leaf springs: OASU1178001 & OASU1178012 M14 x 84 ID (RND) x 235 L
	OASU2384004 \$15 ea.	4	Suits leaf springs: OASU1178002 & OASU1178010 M14 x 84 ID (RND) x 245 L
<i>** All u-bolts hardened steel, rolled threads, deep nuts &amp; spring washers.</i>			
<b>Pins</b>	OASU2500043 \$35 ea.	2	Greasable, hardened steel <i>Must be used with Outback Armour bush kit.</i>
<b>Shackles</b>	OASU2400056 \$50 ea.	2	Greasable, hardened steel pins. <i>Must be used with Outback Armour bush kit.</i>

**ACCESSORY ITEMS & CORRECTION COMPONENTS**

<b>Caster Correction Bush Kits</b>	OASU210100K \$200 kit	1	Rubber - 2 degree caster increase (set of 4).
<b>Correction Components</b>	OASU3322007 \$40 each	2	Rear Sway Bar Link <i>20mm longer than oem. Suits vehicles with rear sway bars and longer travel shock absorbers OASU0160032. 2x required.</i>
	OASU3770001 \$5 kit	1	Brake Bias Spacer Kit <i>Corrects proportioning valve position for correct braking application at lifted suspension heights.</i>
	OASU3770002 \$5 kit	1	Handbrake Cable Bracket Kit <i>Provides extra clearance between the left rear shock absorber and the handbrake cable.</i>
	OASU3770005 \$30 kit	1	Front ABS Bracket Kit <i>Repositions front ABS lines to avoid stretching when articulating.</i>
	OASU3322006 \$20 kit	1	Front Sway Bar Spacer Kit <i>Eliminates front drive shaft and sway bar contact. ** This spacer kit must be used with shock absorber part number OASU0160031.</i>
<b>Coil Spring Spacers</b>	OASU2130217 \$35 ea.	2	Front - 10mm, polyurethane
	OASU2130216 \$105 ea.	2	Front - 30mm, polyurethane
<b>Bump Stops</b>	OASU3770003 \$15 kit	1	Front Coil Spring Jounce Stop Spacer Kit <i>Spaces the bump stop down to provide protection for shock absorbers from damage at full compression..</i>
	OASU3770004 \$25 kit	1	Front Chassis Bump Stop Spacer Kit <i>Spaces the bump stop down to provide protection for shock absorbers from damage at full compression..</i>
	OASU4270004 \$185 pr.	1	Rubber, extended progressive rate (160mm, bonded brackets)

# TOYOTA LANDCRUISER 78 SERIES (V8 2007+)

2007 +



## SUSPENSION KITS - FRONT

PERFORMANCE v	ADJ. INTERNAL BYPASS v	
------------------	---------------------------	--

**Trail Kit A (V8 & V6)** Lift front: 25mm (approx unladen)  
Suits vehicles with oem bumper or light front loads

OASU91780TA <b>\$760 kit</b>	OASU91780TA-ADJ <b>\$850 kit</b>	
2x OASU0160014 (shocks)	2x OASU0165014-ADJ (shocks)	

\* kit prices include shock absorbers listed above plus the following parts \*

1 pair OASU1070001 (coil springs)    1x OASU0954001 (steering damper)

Front bump stop spacer kit "OASU3770003" highly recommended to reduce risk of component damage at full compression. Suits TLC78 Series V8 models & 2007+ V6 models (overseas).

**Expedition Kit A (V8 & V6)** Lift front: 50mm (approx unladen)  
Suits vehicles with a steel bullbar or medium front loads

OASU91780EA <b>\$810 kit</b>	OASU91780EA-ADJ <b>\$900 kit</b>	
2x OASU0160031 (shocks)	2x OASU0165031-ADJ (shocks)	

\* kit prices include shock absorbers listed above plus the following parts \*

1 pair OASU1070002 (coil springs)    1x OASU3322006 (sway bar spr.)    1x OASU3770005 (ABS bracket kit)  
1x OASU0954001 (steering damper)

Front bump stop spacer kits "OASU3770003" & "OASU3770004" highly recommended to reduce risk of component damage at full compression. Suits TLC78 Series V8 models & 2007+ V6 models (overseas).

**Expedition HD Kit A (V8 & V6)** Lift front: 50mm (@ approx 100kg load)  
Suits vehicles with a steel bullbar, winch or heavy front loads

OASU91780HA <b>\$875 kit</b>	OASU91780HA-ADJ <b>\$965 kit</b>	
2x OASU0160031 (shocks)	2x OASU0165031-ADJ (shocks)	

\* kit prices include shock absorbers listed above plus the following parts \*

1 pair OASU1070003 (coil springs)    1x OASU3322006 (sway bar spr.)    1x OASU3770005 (ABS bracket kit)  
1x OASU0954001 (steering damper)

Front bump stop spacer kits "OASU3770003" & "OASU3770004" highly recommended to reduce risk of component damage at full compression. Suits TLC78 Series V8 models & 2007+ V6 models (overseas).

## RECOMMENDED OPTIONS & UPGRADES

<b>Caster Correction Kit</b> OASU210100K <b>\$200 kit</b>	Parts included: 1x OASU210100K (2 degree caster correction kit) Includes: 4x rubber bushes with fitting instructions.
<b>Front Coil Spring Jounce Stop Spacer Kit</b> OASU3770003 <b>\$15 kit</b>	Parts included: 2x Nylon spacers and bolt kit. Includes: 2x 20mm spacers with fitting instructions.

Lift heights are approximate and may vary depending on vehicle or product tolerances and load distribution.

# TOYOTA LANDCRUISER 78 SERIES (V8 2007+)

2007 +



## SUSPENSION KITS - REAR

**PERFORMANCE**

v

**ADJ. INTERNAL BYPASS**

v

### Comfort

Lift rear: 40mm (approx unladen), comfort spring rate  
Suits vehicles with light or occasional medium loads

OASU927800C

\$1,940 kit

2x OASU0160032 (shocks)

OASU927800C-ADJ

\$2,030 kit

2x OASU0165032-ADJ (shocks)

\* kit prices include shock absorbers listed above plus the following parts \*

1x OASU210025K (bush kit)

4x OASU2384002 (u-bolts)

2x OASU1178012 (leaf springs)

1x OASU3770001 (brake bias kit)

1x OASU3770002 (handbrake kit)

2x OASU2500043 (pins)

2x OASU2400056 (shackles)

Rear bump stop kit "OASU4270004" highly recommended to reduce risk of component damage at full compression.  
Longer travel shock absorber. Use extended sway bar links OASU3322007 on vehicles with rear sway bars.

### Trail

Lift rear: 50mm (approx unladen)  
Suits vehicles with light or occasional medium loads

OASU927800T

\$1,940 kit

2x OASU0160032 (shocks)

OASU927800T-ADJ

\$2,030 kit

2x OASU0165032-ADJ (shocks)

\* kit prices include shock absorbers listed above plus the following parts \*

1x OASU210025K (bush kit)

4x OASU2384002 (u-bolts)

2x OASU1178001 (leaf springs)

1x OASU3770001 (brake bias kit)

1x OASU3770002 (handbrake kit)

2x OASU2500043 (pins)

2x OASU2400056 (shackles)

Rear bump stop kit "OASU4270004" highly recommended to reduce risk of component damage at full compression.  
Longer travel shock absorber. Use extended sway bar links OASU3322007 on vehicles with rear sway bars.

### Expedition

Lift rear: 50mm (@ approx 400kg load)  
Suits vehicles with constant medium or occasional heavy loads

OASU927800E

\$2,040 kit

2x OASU0160032 (shocks)

OASU927800E-ADJ

\$2,130 kit

2x OASU0165032-ADJ (shocks)

\* kit prices include shock absorbers listed above plus the following parts \*

1x OASU210025K (bush kit)

4x OASU2384004 (u-bolts)

2x OASU1178002 (leaf springs)

1x OASU3770001 (brake bias kit)

1x OASU3770002 (handbrake kit)

2x OASU2500043 (pins)

2x OASU2400056 (shackles)

Rear bump stop kit "OASU4270004" highly recommended to reduce risk of component damage at full compression.  
Longer travel shock absorber. Use extended sway bar links OASU3322007 on vehicles with rear sway bars.

Lift heights are approximate and may vary depending on vehicle & product tolerances and load distribution.

**TOYOTA LANDCRUISER 78 SERIES (V8 2007+)**

2007 +



**SUSPENSION KITS - REAR**

PERFORMANCE v	ADJ. INTERNAL BYPASS v	
------------------	---------------------------	--

**Expedition HD**

Lift: 50mm rear (@ approx 600kg load)  
Suits vehicles with constant heavy loads

OASU927800H <b>\$2,090 kit</b>	OASU927800H-ADJ <b>\$2,180 kit</b>	
2x OASU0160032 (shocks)	2x OASU0165032-ADJ (shocks)	

\* kit prices include shock absorbers listed above plus the following parts \*

1x OASU210025K (bush kit)	2x OASU1178010 (leaf springs)	2x OASU2500043 (pins)
4x OASU2384004 (u-bolts)	1x OASU3770001 (brake bias kit)	2x OASU2400056 (shackles)
	1x OASU3770002 (handbrake kit)	

Rear bump stop kit "OASU4270004" highly recommended to reduce risk of component damage at full compression.  
Longer travel shock absorber. Use extended sway bar links OASU3322007 on vehicles with rear sway bars.

**RECOMMENDED OPTIONS & UPGRADES**

<p><b>Jounce Stop Kit - Rear</b></p> <p>OASU4270004 <b>\$185 kit</b></p>	<p>Parts included:</p> <p>2x (160mm jounce stops)</p> <p>Rubber, extended progressive rate (160mm, bonded brackets).</p> <p>Highly recommended for all vehicles with heavy rear loads.</p>
--	--

Lift heights are approximate and may vary depending on vehicle & product tolerances and load distribution.



# TOYOTA LANDCRUISER 78 SERIES (V8 2007+)

2007 +



PRODUCT	PART NO.	DETAILS
Leaf Springs	OASU1178012	Trail - 40mm lift comfort (approx unladen) <i>8 primary + 2 secondary</i>
	OASU1178001	Trail - 50mm lift (approx unladen) <i>8 primary + 2 secondary</i>
	OASU1178002	Expedition - 50mm lift (@ approx 400kg load) <i>8 primary + 2 secondary</i>
	OASU1178010	Expedition HD - 50mm lift (@ approx 600kg load) <i>8 primary + 2 secondary</i>

Toyota Landcruiser 78 Series Leaf Spring Deflection

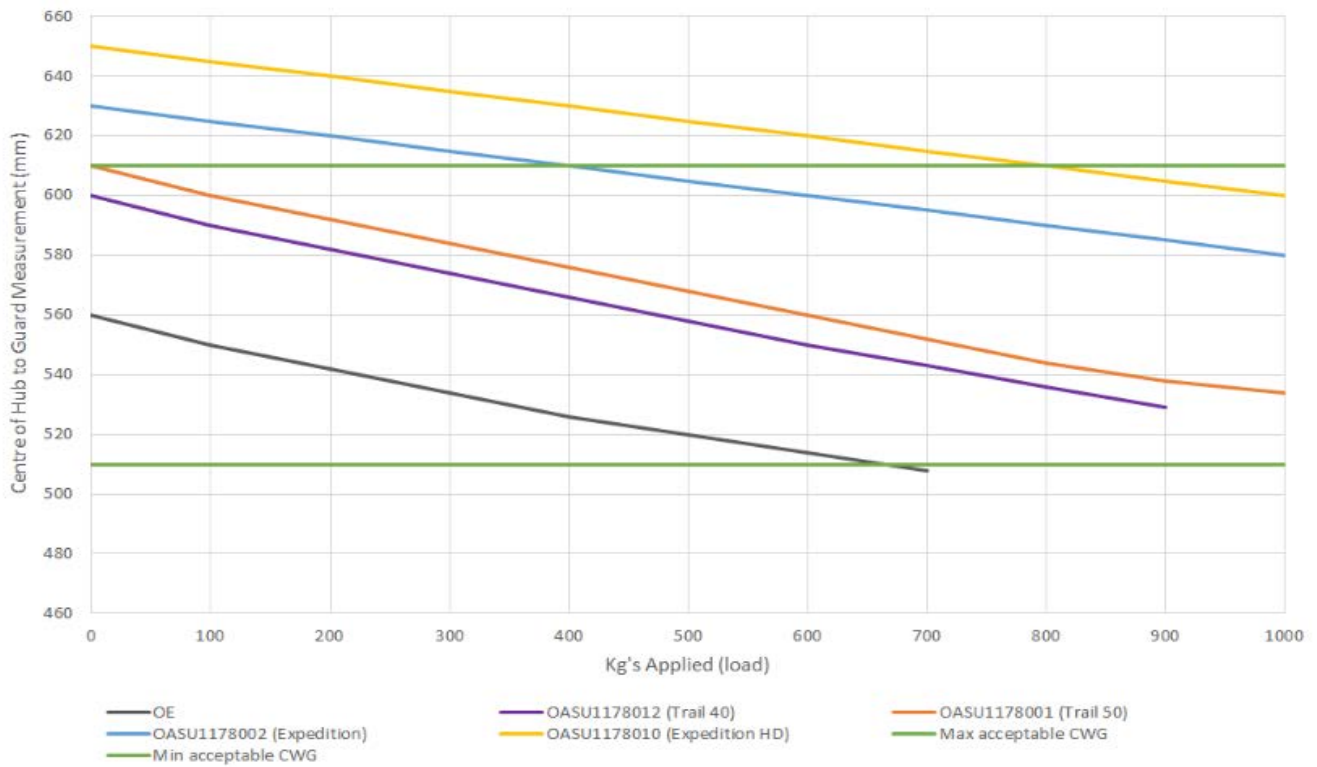

\* CWG (Centre Wheel to Guard) measured from centre of wheel to under-side of guard.

\* Max/Min Acceptable CWG are shown as a recommended guideline only.

\* CWG Heights approximate only, based on a standard dual cab style-side ute with no additional load.

Notes:

TOYOTA LANDCRUISER 79 SERIES SINGLE CAB (6CYL PRE 2007)



2000 - 2006

PRODUCT	PART NO.	QTY	DETAILS
Shock Absorbers (front)	OASU0160014 \$175 ea.	2	<b>Performance</b> - 60mm twin tube. Complete set of rubber bushes, washers included. Steel shroud. <i>Must be used with "Trail" coil spring OASU1070001.</i>
	OASU0165014-ADJ \$220 ea.	2	<b>Adjustable Internal Bypass</b> - 65mm twin tube. Complete set of rubber bushes, washers & dust boot incl. <i>Must be used with "Trail" coil spring OASU1070001.</i>
	OASU0160031 (long travel) \$175 ea.	2	<b>Performance</b> - 60mm twin tube. Complete set of rubber bushes, washers included. Steel shroud. <i>Must be used with coil springs OASU1070002 or OASU1070003. Must use Front Sway Bar Spacer Kit OASU3322006.</i>
	OASU0165031-ADJ (long travel) \$220 ea.	2	<b>Adjustable Internal Bypass</b> - 65mm twin tube. Complete set of rubber bushes, washers & dust boot incl. <i>Must be used with coil springs OASU1070002 or OASU1070003. Must use Front Sway Bar Spacer Kit OASU3322006.</i>
Shock Absorbers (rear)	OASU0160015 \$175 ea.	2	<b>Performance</b> - 60mm twin tube. Complete set of rubber bushes included. Steel shroud. <i>Shock absorber length suits vehicles with rear sway bars or airbags (shorter length than the OASU0160032 part).</i>
	OASU0165015-ADJ \$220 ea.	2	<b>Adjustable Internal Bypass</b> - 65mm twin tube. Complete set of rubber bushes, washers & dust boot incl. <i>Shock absorber length suits vehicles with rear sway bars or airbags (shorter length than the OASU0160032 part).</i>
	OASU0160032 (longer travel) \$175 ea.	2	<b>Performance</b> - 60mm twin tube. Complete set of rubber bushes included. Steel shroud. <i>Longer travel shock absorber. Use extended sway bar links OASU3322007 on vehicles with rear sway bars.</i>
	OASU0165032-ADJ (longer travel) \$220 ea.	2	<b>Adjustable Internal Bypass</b> - 65mm twin tube. Complete set of rubber bushes, washers & dust boot incl. <i>Longer travel shock absorber. Use extended sway bar links OASU3322007 on vehicles with rear sway bars.</i>
Steering Damper	OASU0954002 \$150 ea.	1	51mm twin tube foam cell construction. Complete set of bushes and tapered pins included. Steel shroud. <i>Suits: TLC78 Series 6CYL models up to 2007.</i>
Coil Springs (pair)	OASU1070001 \$260 pr.	1	Trail - 25mm lift (approx unladen) <i>Suits front height correction for bar &amp; winch with oem rear leaf.</i>
	OASU1070002 \$260 pr.	1	Expedition - 50mm lift (approx unladen) <i>Suits lift with oem bumper or bullbar.</i>
	OASU1070003 \$325 pr.	1	Expedition HD - 50mm lift (@ approx 100kg load) <i>Suits lift with heavy steel bullbar and winch combination.</i>
Leaf Springs	OASU1178012 \$575 ea.	2	Comfort - 40mm lift (approx unladen) <i>8 primary + 2 secondary</i>
	OASU1178001 \$575 ea.	2	Trail - 50mm lift (approx unladen) <i>8 primary + 2 secondary</i>
	OASU1178002 \$625 ea.	2	Expedition - 50mm lift (@ approx 400kg load) <i>8 primary + 2 secondary</i>
	OASU1178010 \$650 ea.	2	Expedition HD - 50mm lift (@ approx 600kg load) <i>8 primary + 2 secondary</i>

\*\* Refer leaf spring graph following for approximate deflections under load.



**TOYOTA LANDCRUISER 79 SERIES SINGLE CAB (6CYL PRE 2007)**

2000 - 2006

PRODUCT	PART NO.	QTY	DETAILS
<b>Leaf Spring Bush Kit</b>	OASU210025K \$200 kit	1	12 polyurethane bushes. <i>Must be used with Outback Armour shackles &amp; pins.</i>
<b>U-bolts</b>	OASU2384002 \$15 ea.	4	Suits leaf springs: OASU1178001 M14 x 84 ID (RND) x 235 L
	OASU2384004 \$15 ea.	4	Suits leaf springs: OASU1178002 & OASU1178010 M14 x 84 ID (RND) x 245 L
<i>** All u-bolts hardened steel, rolled threads, deep nuts &amp; spring washers.</i>			
<b>Pins</b>	OASU2500043 \$35 ea.	2	Greasable, hardened steel <i>Must be used with Outback Armour bush kit.</i>
<b>Shackles</b>	OASU2400058 \$50 ea.	2	Greasable, hardened steel pins. <i>Must be used with Outback Armour bush kit.</i>

**ACCESSORY ITEMS & CORRECTION COMPONENTS**

<b>Caster Correction Bush Kits</b>	OASU210100K \$200 kit	1	Rubber - 2 degree caster increase (set of 4).
<b>Correction Components</b>	OASU3322007 \$40 each	2	Rear Sway Bar Link <i>20mm longer than oem. Suits vehicles with rear sway bars and longer travel shock absorbers OASU0160032. 2x required.</i>
	OASU3770001 \$5 kit	1	Brake Bias Spacer Kit <i>Corrects proportioning valve position for correct braking application at lifted suspension heights.</i>
	OASU3770002 \$5 kit	1	Handbrake Cable Bracket Kit <i>Provides extra clearance between the left rear shock absorber and the handbrake cable.</i>
	OASU3770005 \$30 kit	1	Front ABS Bracket Kit <i>Repositions front ABS lines to avoid stretching when articulating.</i>
	OASU3322006 \$20 kit	1	Front Sway Bar Spacer Kit <i>Eliminates front drive shaft and sway bar contact. ** This spacer kit must be used with shock absorber part number OASU0160031.</i>
<b>Coil Spring Spacers</b>	OASU2130217 \$35 ea.	2	Front - 10mm, polyurethane
	OASU2130216 \$105 ea.	2	Front - 30mm, polyurethane
<b>Bump Stops</b>	OASU3770003 \$15 kit	1	Front Coil Spring Jounce Stop Spacer Kit <i>Spaces the bump stop down to provide protection for shock absorbers from damage at full compression..</i>
	OASU3770004 \$25 kit	1	Front Chassis Bump Stop Spacer Kit <i>Spaces the bump stop down to provide protection for shock absorbers from damage at full compression..</i>
	OASU4270004 \$185 pr.	1	Rubber, extended progressive rate (160mm, bonded brackets)

**SUSPENSION KITS - FRONT**

PERFORMANCE v	ADJ. INTERNAL BYPASS v	
------------------	---------------------------	--

**Trail Kit B (6CYL pre 2007)** Lift front: 25mm (approx unladen)  
Suits vehicles with oem bumper or light front loads

OASU91790TB <b>\$760 kit</b>	OASU91790TB-ADJ <b>\$850 kit</b>	
2x OASU0160014 (shocks)	2x OASU0165014-ADJ (shocks)	

\* kit prices include shock absorbers listed above plus the following parts \*

1 pair OASU1070001 (coil springs)    1x OASU0954002 (steering damper)

Front bump stop spacer kit "OASU3770003" highly recommended to reduce risk of component damage at full compression. Suits TLC79 Series 6CYL models up to 2007.

**Expedition Kit B (6CYL pre 2007)** Lift front: 50mm (approx unladen)  
Suits vehicles with a steel bullbar or medium front loads

OASU91790EB <b>\$810 kit</b>	OASU91790EB-ADJ <b>\$900 kit</b>	
2x OASU0160031 (shocks)	2x OASU0165031-ADJ (shocks)	

\* kit prices include shock absorbers listed above plus the following parts \*

1 pair OASU1070002 (coil springs)    1x OASU3322006 (sway bar sprc.)    1x OASU3770005 (ABS bracket kit)  
1x OASU0954002 (steering damper)

Front bump stop spacer kits "OASU3770003" & "OASU3770004" highly recommended to reduce risk of component damage at full compression. Suits TLC79 Series 6CYL models up to 2007.

**Exped HD Kit B (6CYL pre 2007)** Lift front: 50mm (@ approx 100kg load)  
Suits vehicles with a steel bullbar, winch or heavy front loads

OASU91790HB <b>\$875 kit</b>	OASU91790HB-ADJ <b>\$965 kit</b>	
2x OASU0160031 (shocks)	2x OASU0165031-ADJ (shocks)	

\* kit prices include shock absorbers listed above plus the following parts \*

1 pair OASU1070003 (coil springs)    1x OASU3322006 (sway bar sprc.)    1x OASU3770005 (ABS bracket kit)  
1x OASU0954002 (steering damper)

Front bump stop spacer kits "OASU3770003" & "OASU3770004" highly recommended to reduce risk of component damage at full compression. Suits TLC79 Series 6CYL models up to 2007.

**RECOMMENDED OPTIONS & UPGRADES**

<b>Caster Correction Kit</b> OASU210100K <b>\$200 kit</b>	Parts included: 1x OASU210100K (2 degree caster correction kit) Includes: 4x rubber bushes with fitting instructions.
---	---

Lift heights are approximate and may vary depending on vehicle or product tolerances and load distribution.

**SUSPENSION KITS - REAR**

**PERFORMANCE**

v

**ADJ. INTERNAL BYPASS**

v

**Comfort**

Lift rear: 40mm (approx unladen), comfort spring rate  
Suits vehicles with light or occasional medium loads

OASU927900C

\$1,940 kit

2x OASU0160032 (shocks)

OASU927900C-ADJ

\$2,030 kit

2x OASU0165032-ADJ (shocks)

\* kit prices include shock absorbers listed above plus the following parts \*

1x OASU210025K (bush kit)

4x OASU2384002 (u-bolts)

2x OASU1178012 (leaf springs)

1x OASU3770001 (brake bias kit)

1x OASU3770002 (handbrake kit)

2x OASU2500043 (pins)

2x OASU2400058 (shackles)

Rear bump stop kit "OASU4270004" highly recommended to reduce risk of component damage at full compression.  
Longer travel shock absorber. Use extended sway bar links OASU3322007 on vehicles with rear sway bars.

**Trail**

Lift rear: 50mm (approx unladen)  
Suits vehicles with light or occasional medium loads

OASU927900T

\$1,940 kit

2x OASU0160032 (shocks)

OASU927900T-ADJ

\$2,030 kit

2x OASU0165032-ADJ (shocks)

\* kit prices include shock absorbers listed above plus the following parts \*

1x OASU210025K (bush kit)

4x OASU2384002 (u-bolts)

2x OASU1178001 (leaf springs)

1x OASU3770001 (brake bias kit)

1x OASU3770002 (handbrake kit)

2x OASU2500043 (pins)

2x OASU2400058 (shackles)

Rear bump stop kit "OASU4270004" highly recommended to reduce risk of component damage at full compression.  
Longer travel shock absorber. Use extended sway bar links OASU3322007 on vehicles with rear sway bars.

**Expedition**

Lift rear: 50mm (@ approx 400kg load)  
Suits vehicles with constant medium or occasional heavy loads

OASU927900E

\$2,040 kit

2x OASU0160032 (shocks)

OASU927900E-ADJ

\$2,130 kit

2x OASU0165032-ADJ (shocks)

\* kit prices include shock absorbers listed above plus the following parts \*

1x OASU210025K (bush kit)

4x OASU2384004 (u-bolts)

2x OASU1178002 (leaf springs)

1x OASU3770001 (brake bias kit)

1x OASU3770002 (handbrake kit)

2x OASU2500043 (pins)

2x OASU2400058 (shackles)

Rear bump stop kit "OASU4270004" highly recommended to reduce risk of component damage at full compression.  
Longer travel shock absorber. Use extended sway bar links OASU3322007 on vehicles with rear sway bars.

Lift heights are approximate and may vary depending on vehicle & product tolerances and load distribution.

**SUSPENSION KITS - REAR**

PERFORMANCE v	ADJ. INTERNAL BYPASS v	
------------------	---------------------------	--

**Expedition HD**

Lift rear: 50mm (@ approx 600kg load)  
Suits vehicles with constant heavy loads

OASU927900H <b>\$2,090 kit</b>	OASU927900H-ADJ <b>\$2,180 kit</b>	
2x OASU0160032 (shocks)	2x OASU0165032-ADJ (shocks)	

\* kit prices include shock absorbers listed above plus the following parts \*

- |                           |                                 |                           |
|---------------------------|---------------------------------|---------------------------|
| 1x OASU210025K (bush kit) | 2x OASU1178010 (leaf springs)   | 2x OASU2500043 (pins)     |
| 4x OASU2384004 (u-bolts)  | 1x OASU3770001 (brake bias kit) | 2x OASU2400058 (shackles) |
|                           | 1x OASU3770002 (handbrake kit)  |                           |

Rear bump stop kit "OASU4270004" highly recommended to reduce risk of component damage at full compression.  
Longer travel shock absorber. Use extended sway bar links OASU3322007 on vehicles with rear sway bars.

**RECOMMENDED OPTIONS & UPGRADES**

<p><b>Jounce Stop Kit - Rear</b></p> <p>OASU4270004 <b>\$185 kit</b></p>	<p>Parts included:</p> <p>2x (160mm jounce stops)</p> <p>Rubber, extended progressive rate (160mm, bonded brackets).</p> <p>Highly recommended for all vehicles with heavy rear loads.</p>
--	--

Lift heights are approximate and may vary depending on vehicle & product tolerances and load distribution.

PRODUCT	PART NO.	DETAILS
Leaf Springs	OASU1178012	Trail - 40mm lift comfort (approx unladen) <i>8 primary + 2 secondary</i>
	OASU1178001	Trail - 50mm lift (approx unladen) <i>8 primary + 2 secondary</i>
	OASU1178002	Expedition - 50mm lift (@ approx 400kg load) <i>8 primary + 2 secondary</i>
	OASU1178010	Expedition HD - 50mm lift (@ approx 600kg load) <i>8 primary + 2 secondary</i>

Toyota Landcruiser 79 Series Leaf Spring Deflection

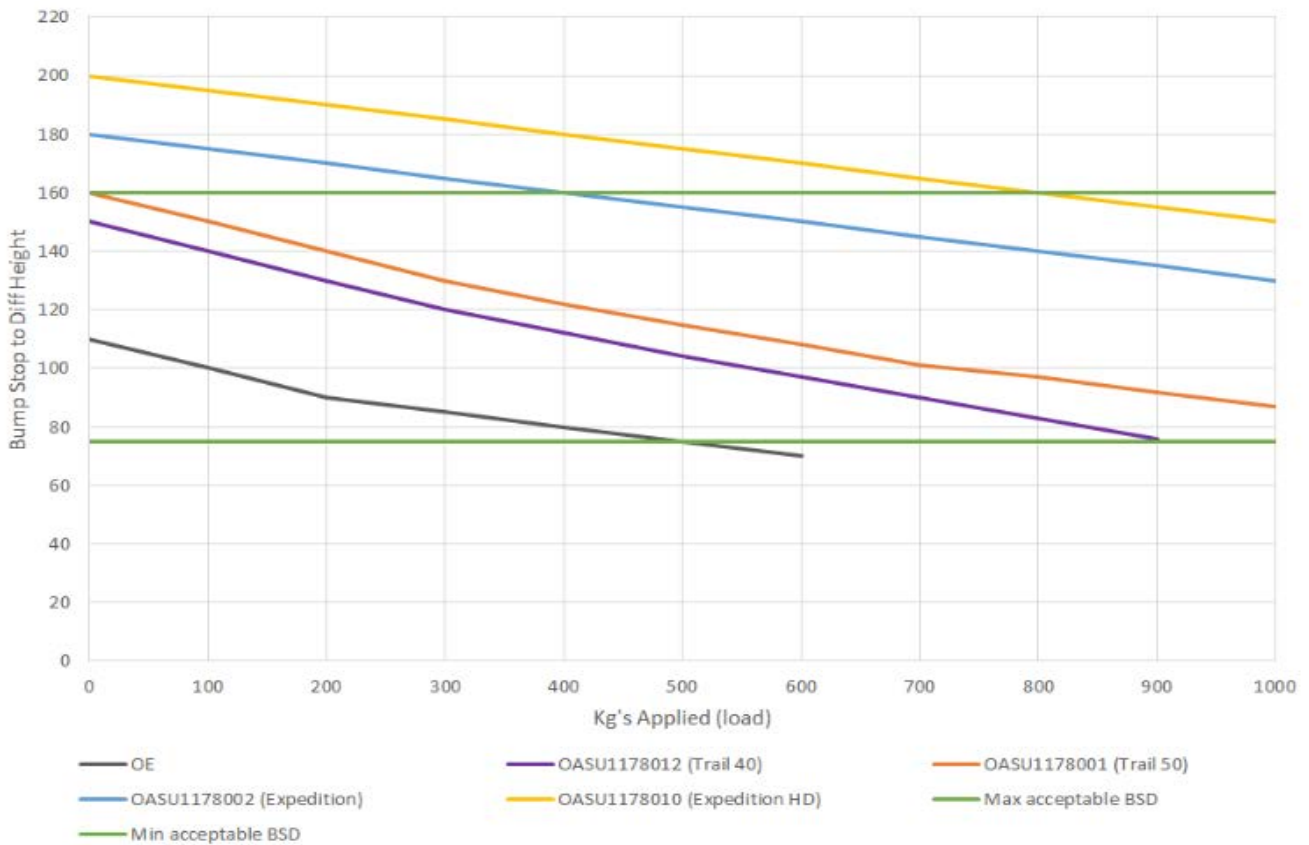

\* CWG (Centre Wheel to Guard) measured from centre of wheel to under-side of guard.

\* Max/Min Acceptable CWG are shown as a recommended guideline only.

\* CWG Heights approximate only, based on a standard dual cab style-side ute with no additional load.

Notes:

**TOYOTA LANDCRUISER 79 SERIES SINGLE/DUAL CAB (V8 '07-'16)**

2007 - 2016



PRODUCT	PART NO.	QTY	DETAILS
<b>Shock Absorbers</b> (front)	OASU0160014 \$175 ea.	2	<b>Performance</b> - 60mm twin tube. Complete set of rubber bushes, washers included. Steel shroud. <i>Must be used with "Trail" coil spring OASU1070001.</i>
	OASU0165014-ADJ \$220 ea.	2	<b>Adjustable Internal Bypass</b> - 65mm twin tube. Complete set of rubber bushes, washers & dust boot incl. <i>Must be used with "Trail" coil spring OASU1070001.</i>
	OASU0160031 (long travel) \$175 ea.	2	<b>Performance</b> - 60mm twin tube. Complete set of rubber bushes, washers included. Steel shroud. <i>Must be used with coil springs OASU1070002 or OASU1070003. Must use Front Sway Bar Spacer Kit OASU3322006.</i>
	OASU0165031-ADJ (long travel) \$220 ea.	2	<b>Adjustable Internal Bypass</b> - 65mm twin tube. Complete set of rubber bushes, washers & dust boot incl. <i>Must be used with coil springs OASU1070002 or OASU1070003. Must use Front Sway Bar Spacer Kit OASU3322006.</i>
<b>Shock Absorbers</b> (rear)	OASU0160015 \$175 ea.	2	<b>Performance</b> - 60mm twin tube. Complete set of rubber bushes included. Steel shroud. <i>Shock absorber length suits vehicles with rear sway bars or airbags (shorter length than the OASU0160032 part).</i>
	OASU0165015-ADJ \$220 ea.	2	<b>Adjustable Internal Bypass</b> - 65mm twin tube. Complete set of rubber bushes, washers & dust boot incl. <i>Shock absorber length suits vehicles with rear sway bars or airbags (shorter length than the OASU0160032 part).</i>
	OASU0160032 (longer travel) \$175 ea.	2	<b>Performance</b> - 60mm twin tube. Complete set of rubber bushes included. Steel shroud. <i>Longer travel shock absorber. Use extended sway bar links OASU3322007 on vehicles with rear sway bars.</i>
	OASU0165032-ADJ (longer travel) \$220 ea.	2	<b>Adjustable Internal Bypass</b> - 65mm twin tube. Complete set of rubber bushes, washers & dust boot incl. <i>Longer travel shock absorber. Use extended sway bar links OASU3322007 on vehicles with rear sway bars.</i>
<b>Steering Damper</b>	OASU0954001 \$150 ea.	1	51mm twin tube foam cell construction. Complete set of bushes and tapered pins included. Steel shroud. <i>Suits: TLC78 Series V8 models &amp; 2007+ 6CYL models (overseas).</i>
<b>Coil Springs</b> (pair)	OASU1070001 \$260 pr.	1	Trail - 25mm lift (approx unladen) <i>Suits front height correction for bar &amp; winch with oem rear leaf.</i>
	OASU1070002 \$260 pr.	1	Expedition - 50mm lift (approx unladen) <i>Suits lift with oem bumper or bullbar.</i>
	OASU1070003 \$325 pr.	1	Expedition HD - 50mm lift (@ approx 100kg load) <i>Suits lift with heavy steel bullbar and winch combination.</i>
<b>Leaf Springs</b>	OASU1178012 \$575 ea.	2	Comfort - 40mm lift (approx unladen) <i>8 primary + 2 secondary</i>
	OASU1178001 \$575 ea.	2	Trail - 50mm lift (approx unladen) <i>8 primary + 2 secondary</i>
	OASU1178002 \$625 ea.	2	Expedition - 50mm lift (@ approx 400kg load) <i>8 primary + 2 secondary</i>
	OASU1178010 \$650 ea.	2	Expedition HD - 50mm lift (@ approx 600kg load) <i>8 primary + 2 secondary</i>

\*\* Refer leaf spring graph following for approximate deflections under load.



**TOYOTA LANDCRUISER 79 SERIES SINGLE/DUAL CAB (V8 '07-'16)**

2007 - 2016

PRODUCT	PART NO.	QTY	DETAILS
<b>Leaf Spring Bush Kit</b>	OASU210025K \$200 kit	1	12 polyurethane bushes. <i>Must be used with Outback Armour shackles &amp; pins.</i>
<b>U-bolts</b>	OASU2384002 \$15 ea.	4	Suits leaf springs: OASU1178001 M14 x 84 ID (RND) x 235 L
	OASU2384004 \$15 ea.	4	Suits leaf springs: OASU1178002 & OASU1178010 M14 x 84 ID (RND) x 245 L
<i>** All u-bolts hardened steel, rolled threads, deep nuts &amp; spring washers.</i>			
<b>Pins</b>	OASU2500043 \$35 ea.	2	Greasable, hardened steel <i>Must be used with Outback Armour bush kit.</i>
<b>Shackles</b>	OASU2400058 \$50 ea.	2	Greasable, hardened steel pins. <i>Must be used with Outback Armour bush kit.</i>

**ACCESSORY ITEMS & CORRECTION COMPONENTS**

<b>Caster Correction Bush Kits</b>	OASU210100K \$200 kit	1	Rubber - 2 degree caster increase (set of 4).
<b>Correction Components</b>	OASU3322007 \$40 each	2	Rear Sway Bar Link <i>20mm longer than oem. Suits vehicles with rear sway bars and longer travel shock absorbers OASU0160032. 2x required.</i>
	OASU3770001 \$5 kit	1	Brake Bias Spacer Kit <i>Corrects proportioning valve position for correct braking application at lifted suspension heights.</i>
	OASU3770002 \$5 kit	1	Handbrake Cable Bracket Kit <i>Provides extra clearance between the left rear shock absorber and the handbrake cable.</i>
	OASU3770005 \$30 kit	1	Front ABS Bracket Kit <i>Repositions front ABS lines to avoid stretching when articulating.</i>
	OASU3322006 \$20 kit	1	Front Sway Bar Spacer Kit <i>Eliminates front drive shaft and sway bar contact. ** This spacer kit must be used with shock absorber part number OASU0160031.</i>
<b>Coil Spring Spacers</b>	OASU2130217 \$35 ea.	2	Front - 10mm, polyurethane
	OASU2130216 \$105 ea.	2	Front - 30mm, polyurethane
<b>Bump Stops</b>	OASU3770003 \$15 kit	1	Front Coil Spring Jounce Stop Spacer Kit <i>Spaces the bump stop down to provide protection for shock absorbers from damage at full compression..</i>
	OASU3770004 \$25 kit	1	Front Chassis Bump Stop Spacer Kit <i>Spaces the bump stop down to provide protection for shock absorbers from damage at full compression..</i>
	OASU4270004 \$185 pr.	1	Rubber, extended progressive rate (160mm, bonded brackets)

**SUSPENSION KITS - FRONT**

PERFORMANCE v	ADJ. INTERNAL BYPASS v	
------------------	---------------------------	--

**Trail Kit A (V8 & V6)** Lift front: 25mm (approx unladen)  
Suits vehicles with oem bumper or light front loads

OASU91790TA <b>\$760 kit</b>	OASU91790TA-ADJ <b>\$850 kit</b>	
2x OASU0160014 (shocks)	2x OASU0165014-ADJ (shocks)	

\* kit prices include shock absorbers listed above plus the following parts \*

1 pair OASU1070001 (coil springs)    1x OASU0954001 (steering damper)

Front bump stop spacer kit "OASU3770003" highly recommended to reduce risk of component damage at full compression. Suits TLC79 Series V8 models & 2007+ V6 models (overseas).

**Expedition Kit A (V8 & V6)** Lift front: 50mm (approx unladen)  
Suits vehicles with a steel bullbar or medium front loads

OASU91790EA <b>\$810 kit</b>	OASU91790EA-ADJ <b>\$900 kit</b>	
2x OASU0160031 (shocks)	2x OASU0165031-ADJ (shocks)	

\* kit prices include shock absorbers listed above plus the following parts \*

1 pair OASU1070002 (coil springs)    1x OASU3322006 (sway bar sprc.)    1x OASU3770005 (ABS bracket kit)  
1x OASU0954001 (steering damper)

Front bump stop spacer kits "OASU3770003" & "OASU3770004" highly recommended to reduce risk of component damage at full compression. Suits TLC79 Series V8 models & 2007+ V6 models (overseas).

**Exped HD Kit A (V8 & V6)** Lift front: 50mm (@ approx 100kg load)  
Suits vehicles with a steel bullbar, winch or heavy front loads

OASU91790HA <b>\$875 kit</b>	OASU91790HA-ADJ <b>\$965 kit</b>	
2x OASU0160031 (shocks)	2x OASU0165031-ADJ (shocks)	

\* kit prices include shock absorbers listed above plus the following parts \*

1 pair OASU1070003 (coil springs)    1x OASU3322006 (sway bar sprc.)    1x OASU3770005 (ABS bracket kit)  
1x OASU0954001 (steering damper)

Front bump stop spacer kits "OASU3770003" & "OASU3770004" highly recommended to reduce risk of component damage at full compression. Suits TLC79 Series V8 models & 2007+ V6 models (overseas).

**RECOMMENDED OPTIONS & UPGRADES**

<b>Caster Correction Kit</b> OASU210100K <b>\$200 kit</b>	Parts included: 1x OASU210100K (2 degree caster correction kit) Includes: 4x rubber bushes with fitting instructions.
---	---

Lift heights are approximate and may vary depending on vehicle or product tolerances and load distribution.



**SUSPENSION KITS - REAR**

**PERFORMANCE**

v

**ADJ. INTERNAL BYPASS**

v

**Comfort**

Lift rear: 40mm (approx unladen), comfort spring rate  
Suits vehicles with light or occasional medium loads

OASU927900C

\$1,940 kit

2x OASU0160032 (shocks)

OASU927900C-ADJ

\$2,030 kit

2x OASU0165032-ADJ (shocks)

\* kit prices include shock absorbers listed above plus the following parts \*

1x OASU210025K (bush kit)

4x OASU2384002 (u-bolts)

2x OASU1178012 (leaf springs)

1x OASU3770001 (brake bias kit)

1x OASU3770002 (handbrake kit)

2x OASU2500043 (pins)

2x OASU2400058 (shackles)

Rear bump stop kit "OASU4270004" highly recommended to reduce risk of component damage at full compression.  
Longer travel shock absorber. Use extended sway bar links OASU3322007 on vehicles with rear sway bars.

**Trail**

Lift rear: 50mm (approx unladen)  
Suits vehicles with light or occasional medium loads

OASU927900T

\$1,940 kit

2x OASU0160032 (shocks)

OASU927900T-ADJ

\$2,030 kit

2x OASU0165032-ADJ (shocks)

\* kit prices include shock absorbers listed above plus the following parts \*

1x OASU210025K (bush kit)

4x OASU2384002 (u-bolts)

2x OASU1178001 (leaf springs)

1x OASU3770001 (brake bias kit)

1x OASU3770002 (handbrake kit)

2x OASU2500043 (pins)

2x OASU2400058 (shackles)

Rear bump stop kit "OASU4270004" highly recommended to reduce risk of component damage at full compression.  
Longer travel shock absorber. Use extended sway bar links OASU3322007 on vehicles with rear sway bars.

**Expedition**

Lift rear: 50mm (@ approx 400kg load)  
Suits vehicles with constant medium or occasional heavy loads

OASU927900E

\$2,040 kit

2x OASU0160032 (shocks)

OASU927900E-ADJ

\$2,130 kit

2x OASU0165032-ADJ (shocks)

\* kit prices include shock absorbers listed above plus the following parts \*

1x OASU210025K (bush kit)

4x OASU2384004 (u-bolts)

2x OASU1178002 (leaf springs)

1x OASU3770001 (brake bias kit)

1x OASU3770002 (handbrake kit)

2x OASU2500043 (pins)

2x OASU2400058 (shackles)

Rear bump stop kit "OASU4270004" highly recommended to reduce risk of component damage at full compression.  
Longer travel shock absorber. Use extended sway bar links OASU3322007 on vehicles with rear sway bars.

Lift heights are approximate and may vary depending on vehicle & product tolerances and load distribution.

**SUSPENSION KITS - REAR**

PERFORMANCE v	ADJ. INTERNAL BYPASS v	
------------------	---------------------------	--

**Expedition HD**

Lift rear: 50mm (@ approx 600kg load)  
Suits vehicles with constant heavy loads

OASU927900H <b>\$2,090 kit</b>	OASU927900H-ADJ <b>\$2,180 kit</b>	
2x OASU0160032 (shocks)	2x OASU0165032-ADJ (shocks)	

\* kit prices include shock absorbers listed above plus the following parts \*

1x OASU210025K (bush kit)	2x OASU1178010 (leaf springs)	2x OASU2500043 (pins)
4x OASU2384004 (u-bolts)	1x OASU3770001 (brake bias kit)	2x OASU2400058 (shackles)
	1x OASU3770002 (handbrake kit)	

Rear bump stop kit "OASU4270004" highly recommended to reduce risk of component damage at full compression.  
Longer travel shock absorber. Use extended sway bar links OASU3322007 on vehicles with rear sway bars.

**RECOMMENDED OPTIONS & UPGRADES**

<p><b>Jounce Stop Kit - Rear</b></p> <p>OASU4270004 <b>\$185 kit</b></p>	<p>Parts included:</p> <p>2x (160mm jounce stops)</p> <p>Rubber, extended progressive rate (160mm, bonded brackets).</p> <p>Highly recommended for all vehicles with heavy rear loads.</p>
--	--

Lift heights are approximate and may vary depending on vehicle & product tolerances and load distribution.

PRODUCT	PART NO.	DETAILS
Leaf Springs	OASU1178012	Trail - 40mm lift comfort (approx unladen) <i>8 primary + 2 secondary</i>
	OASU1178001	Trail - 50mm lift (approx unladen) <i>8 primary + 2 secondary</i>
	OASU1178002	Expedition - 50mm lift (@ approx 400kg load) <i>8 primary + 2 secondary</i>
	OASU1178010	Expedition HD - 50mm lift (@ approx 600kg load) <i>8 primary + 2 secondary</i>

Toyota Landcruiser 79 Series Leaf Spring Deflection

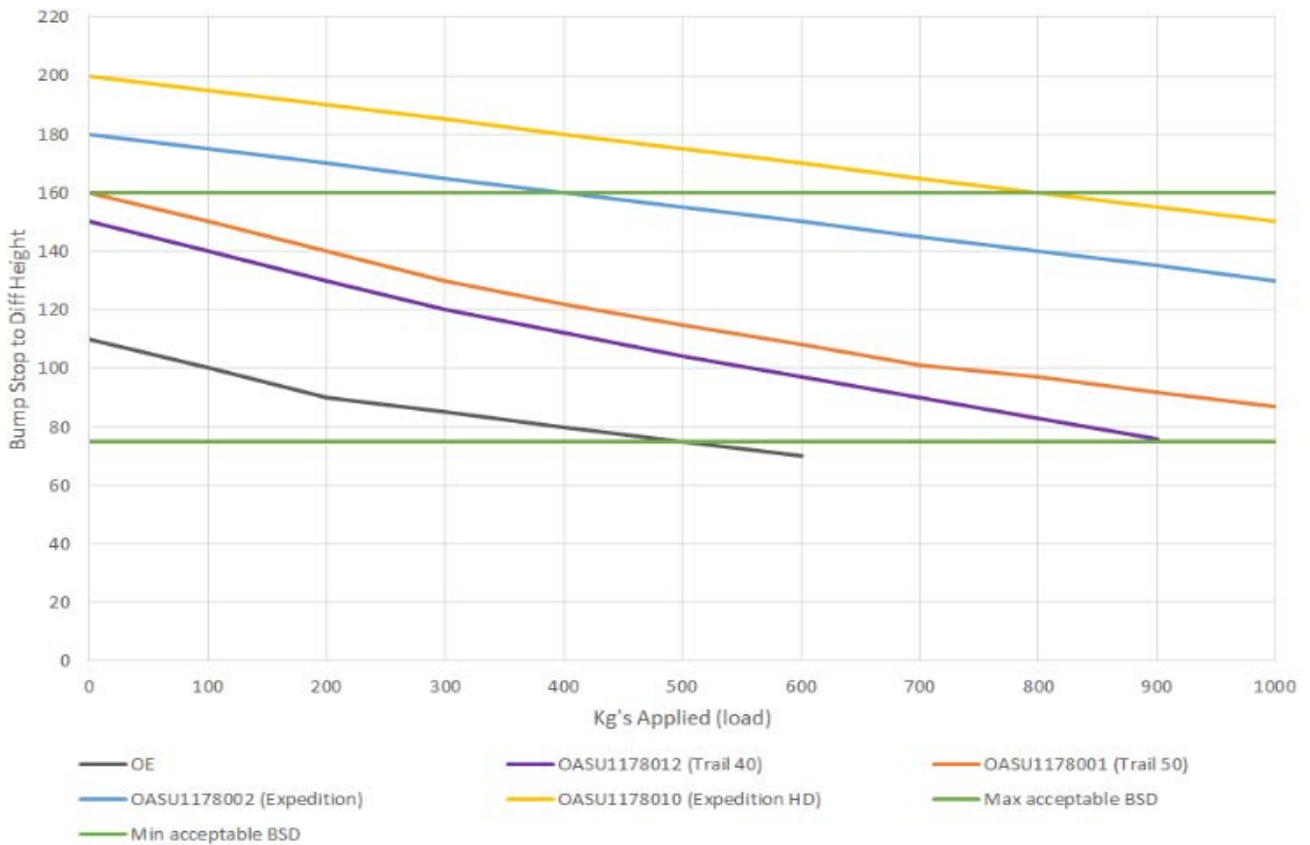

\* CWG (Centre Wheel to Guard) measured from centre of wheel to under-side of guard.

\* Max/Min Acceptable CWG are shown as a recommended guideline only.

\* CWG Heights approximate only, based on a standard dual cab style-side ute with no additional load.

Notes:

**TOYOTA LANDCRUISER 79 SERIES SINGLE CAB (V8 2017+)**

2017 + (models with new chassis design &amp; DPF)



PRODUCT	PART NO.	QTY	DETAILS
<b>Shock Absorbers (front)</b>	OASU0160014 \$175 ea.	2	<b>Performance</b> - 60mm twin tube. Complete set of rubber bushes, washers included. Steel shroud. <i>Must be used with "Trail" coil spring OASU1070001.</i>
	OASU0165014-ADJ \$220 ea.	2	<b>Adjustable Internal Bypass</b> - 65mm twin tube. Complete set of rubber bushes, washers & dust boot incl. <i>Must be used with "Trail" coil spring OASU1070001.</i>
<b>Shock Absorbers (rear)</b>	OASU0160015 \$175 ea.	2	<b>Performance</b> - 60mm twin tube. Complete set of rubber bushes included. Steel shroud. <i>Shock absorber length suits vehicles with rear sway bars or airbags (shorter length than the OASU0160032 part).</i>
	OASU0165015-ADJ \$220 ea.	2	<b>Adjustable Internal Bypass</b> - 65mm twin tube. Complete set of rubber bushes, washers & dust boot incl. <i>Shock absorber length suits vehicles with rear sway bars or airbags (shorter length than the OASU0160032 part).</i>
	OASU0160032 (longer travel) \$175 ea.	2	<b>Performance</b> - 60mm twin tube. Complete set of rubber bushes included. Steel shroud. <i>Longer travel shock absorber. Use extended sway bar links OASU3322007 on vehicles with rear sway bars.</i>
	OASU0165032-ADJ (longer travel) \$220 ea.	2	<b>Adjustable Internal Bypass</b> - 65mm twin tube. Complete set of rubber bushes, washers & dust boot incl. <i>Longer travel shock absorber. Use extended sway bar links OASU3322007 on vehicles with rear sway bars.</i>
<b>Steering Damper</b>	OASU0954001 \$150 ea.	1	51mm twin tube foam cell construction. Complete set of bushes and tapered pins included. Steel shroud. <i>Suits: TLC78 Series V8 models &amp; 2007+ 6CYL models (overseas).</i>
<b>Coil Springs (pair)</b>	OASU1070001 \$260 pr.	1	<b>Trail</b> - 25mm lift (approx unladen) <i>Suits front height correction for bar &amp; winch with oem rear leaf.</i>
	OASU1070002 \$260 pr.	1	<b>Expedition</b> - 50mm lift (approx unladen) <i>Suits lift with oem bumper or bullbar.</i>
	OASU1070003 \$325 pr.	1	<b>Expedition HD</b> - 50mm lift (@ approx 100kg load) <i>Suits lift with heavy steel bullbar and winch combination.</i>
<b>Leaf Springs</b>	OASU1178012 \$575 ea.	2	<b>Comfort</b> - 40mm lift (approx unladen) <i>8 primary + 2 secondary</i>
	OASU1178001 \$575 ea.	2	<b>Trail</b> - 50mm lift (approx unladen) <i>8 primary + 2 secondary</i>
	OASU1178002 \$625 ea.	2	<b>Expedition</b> - 50mm lift (@ approx 400kg load) <i>8 primary + 2 secondary</i>
	OASU1178010 \$650 ea.	2	<b>Expedition HD</b> - 50mm lift (@ approx 600kg load) <i>8 primary + 2 secondary</i>
<i>** Refer leaf spring graph following for approximate deflections under load.</i>			
<b>Leaf Spring Bush Kit</b>	OASU210025K \$200 kit	1	12 polyurethane bushes. <i>Must be used with Outback Armour shackles &amp; pins.</i>
<b>U-bolts</b>	OASU2384002 \$15 ea.	4	Suits leaf springs: OASU1178001 <i>M14 x 84 ID (RND) x 235 L</i>
	OASU2384004 \$15 ea.	4	Suits leaf springs: OASU1178002 & OASU1178010 <i>M14 x 84 ID (RND) x 245 L</i>
<i>** All u-bolts hardened steel, rolled threads, deep nuts &amp; spring washers.</i>			
<b>Pins</b>	OASU2500043 \$35 ea.	2	Greasable, hardened steel <i>Must be used with Outback Armour bush kit.</i>
<b>Shackles</b>	OASU2400058 \$50 ea.	2	Greasable, hardened steel pins. <i>Must be used with Outback Armour bush kit.</i>

**TOYOTA LANDCRUISER 79 SERIES SINGLE CAB (V8 2017+)**

2017 + (models with new chassis design &amp; DPF)



PRODUCT	PART NO.	QTY	DETAILS
<b>ACCESSORY ITEMS &amp; CORRECTION COMPONENTS</b>			
<b>Caster Correction Bush Kits</b>	OASU210100K \$200 kit	1	Rubber - 2 degree caster increase (set of 4).
<b>Correction Components</b>	OASU3322007 \$40 each	2	Rear Sway Bar Link <i>20mm longer than oem. Suits vehicles with rear sway bars and longer travel shock absorbers OASU0160032. 2x required.</i>
	OASU3770002 \$5 kit	1	Handbrake Cable Bracket Kit <i>Provides extra clearance between the left rear shock absorber and the handbrake cable.</i>
	OASU3770009 \$30 kit	1	Front ABS Bracket Kit (Single Cab 2017+) <i>Repositions front ABS lines to avoid stretching when articulating.</i>
	OASU3322006 \$20 kit	1	Front Sway Bar Spacer Kit <i>Eliminates front drive shaft and sway bar contact. ** This spacer kit must be used with shock absorber part number OASU0160031.</i>
<b>Coil Spring Spacers</b>	OASU2130217 \$35 ea.	2	Front - 10mm, polyurethane
	OASU2130216 \$105 ea.	2	Front - 30mm, polyurethane
<b>Bump Stops</b>	OASU3770003 \$15 kit	1	Front Coil Spring Jounce Stop Spacer Kit <i>Spaces the bump stop down to provide protection for shock absorbers from damage at full compression..</i>
	OASU3770004 \$25 kit	1	Front Chassis Bump Stop Spacer Kit <i>Spaces the bump stop down to provide protection for shock absorbers from damage at full compression..</i>
	OASU4270004 \$185 pr.	1	Rubber, extended progressive rate (160mm, bonded brackets)

# TOYOTA LANDCRUISER 79 SERIES SINGLE CAB (V8 2017+)

2017 + (models with new chassis design & DPF)



## SUSPENSION KITS - FRONT

PERFORMANCE v	ADJ. INTERNAL BYPASS v	
------------------	---------------------------	--

**Trail** Lift front: 25mm (approx unladen)  
Suits vehicles with oem bumper or light front loads

OASU917901T <b>\$810 kit</b>	OASU917901T-ADJ <b>\$900 kit</b>	
2x OASU0160014 (shocks)	2x OASU0165014-ADJ (shocks)	

\* kit prices include shock absorbers listed above plus the following parts \*

1 pair OASU1070001 (coil springs)    1x OASU3322006 (sway bar spr.)    1x OASU3770009 (ABS bracket kit)  
1x OASU0954001 (steering damper)

Front bump stop spacer kit "OASU3770003" highly recommended to reduce risk of component damage at full compression. Suits TLC79 Series V8 models & 2017+ (models with new chassis design & DPF).

**Expedition** Lift front: 50mm (approx unladen)  
Suits vehicles with a steel bullbar or medium front loads

OASU917901E <b>\$810 kit</b>	OASU917901E-ADJ <b>\$900 kit</b>	
2x OASU0160014 (shocks)	2x OASU0165014-ADJ (shocks)	

\* kit prices include shock absorbers listed above plus the following parts \*

1 pair OASU1070002 (coil springs)    1x OASU3322006 (sway bar spr.)    1x OASU3770009 (ABS bracket kit)  
1x OASU0954001 (steering damper)

Front bump stop spacer kits "OASU3770003" & "OASU3770004" highly recommended to reduce risk of component damage at full compression. Suits TLC79 Series V8 models & 2017+ (models with new chassis design & DPF).

**Expedition HD** Lift front: 50mm (@ approx 100kg load)  
Suits vehicles with a steel bullbar, winch or heavy front loads

OASU917901H <b>\$875 kit</b>	OASU917901H-ADJ <b>\$965 kit</b>	
2x OASU0160014 (shocks)	2x OASU0165014-ADJ (shocks)	

\* kit prices include shock absorbers listed above plus the following parts \*

1 pair OASU1070003 (coil springs)    1x OASU3322006 (sway bar spr.)    1x OASU3770009 (ABS bracket kit)  
1x OASU0954001 (steering damper)

Front bump stop spacer kits "OASU3770003" & "OASU3770004" highly recommended to reduce risk of component damage at full compression. Suits TLC79 Series V8 models & 2017+ (models with new chassis design & DPF).

## RECOMMENDED OPTIONS & UPGRADES

<b>Caster Correction Kit</b> OASU210100K <b>\$200 kit</b>	Parts included: 1x OASU210100K (2 degree caster correction kit) Includes: 4x rubber bushes with fitting instructions.
---	---

Lift heights are approximate and may vary depending on vehicle or product tolerances and load distribution.

# TOYOTA LANDCRUISER 79 SERIES SINGLE CAB (V8 2017+)

2017 + (models with new chassis design & DPF)



## SUSPENSION KITS - REAR

PERFORMANCE v	ADJ. INTERNAL BYPASS v	
------------------	---------------------------	--

### Comfort

Lift rear: 40mm (approx unladen), comfort spring rate  
Suits vehicles with light or occasional medium loads

OASU927900C <b>\$1,935 kit</b>	OASU927900C-ADJ <b>\$2,025 kit</b>	
2x OASU0160032 (shocks)	2x OASU0165032-ADJ (shocks)	

\* kit prices include shock absorbers listed above plus the following parts \*

1x OASU210025K (bush kit)	2x OASU1178012 (leaf springs)	2x OASU2500043 (pins)
4x OASU2384002 (u-bolts)	1x OASU3770002 (handbrake kit)	2x OASU2400058 (shackles)

Rear bump stop kit "OASU4270004" highly recommended to reduce risk of component damage at full compression.  
Longer travel shock absorber. Use extended sway bar links OASU3322007 on vehicles with rear sway bars.

### Trail

Lift rear: 50mm (approx unladen)  
Suits vehicles with light or occasional medium loads

OASU927900T <b>\$1,935 kit</b>	OASU927900T-ADJ <b>\$2,025 kit</b>	
2x OASU0160032 (shocks)	2x OASU0165032-ADJ (shocks)	

\* kit prices include shock absorbers listed above plus the following parts \*

1x OASU210025K (bush kit)	2x OASU1178001 (leaf springs)	2x OASU2500043 (pins)
4x OASU2384002 (u-bolts)	1x OASU3770002 (handbrake kit)	2x OASU2400058 (shackles)

Rear bump stop kit "OASU4270004" highly recommended to reduce risk of component damage at full compression.  
Longer travel shock absorber. Use extended sway bar links OASU3322007 on vehicles with rear sway bars.

### Expedition

Lift rear: 50mm (@ approx 400kg load)  
Suits vehicles with constant medium or occasional heavy loads

OASU927900E <b>\$2,035 kit</b>	OASU927900E-ADJ <b>\$2,125 kit</b>	
2x OASU0160032 (shocks)	2x OASU0165032-ADJ (shocks)	

\* kit prices include shock absorbers listed above plus the following parts \*

1x OASU210025K (bush kit)	2x OASU1178002 (leaf springs)	2x OASU2500043 (pins)
4x OASU2384004 (u-bolts)	1x OASU3770002 (handbrake kit)	2x OASU2400058 (shackles)

Rear bump stop kit "OASU4270004" highly recommended to reduce risk of component damage at full compression.  
Longer travel shock absorber. Use extended sway bar links OASU3322007 on vehicles with rear sway bars.

Lift heights are approximate and may vary depending on vehicle & product tolerances and load distribution.



**TOYOTA LANDCRUISER 79 SERIES SINGLE CAB (V8 2017+)**

2017 + (models with new chassis design & DPF)



**SUSPENSION KITS - REAR**

PERFORMANCE v	ADJ. INTERNAL BYPASS v	
------------------	---------------------------	--

**Expedition HD**

Lift rear: 50mm (@ approx 600kg load)  
Suits vehicles with constant heavy loads

OASU927900H <b>\$2,085 kit</b>	OASU927900H-ADJ <b>\$2,175 kit</b>	
2x OASU0160032 (shocks)	2x OASU0165032-ADJ (shocks)	

\* kit prices include shock absorbers listed above plus the following parts \*

- |                           |                                |                           |
|---------------------------|--------------------------------|---------------------------|
| 1x OASU210025K (bush kit) | 2x OASU1178010 (leaf springs)  | 2x OASU2500043 (pins)     |
| 4x OASU2384004 (u-bolts)  | 1x OASU3770002 (handbrake kit) | 2x OASU2400058 (shackles) |

Rear bump stop kit "OASU4270004" highly recommended to reduce risk of component damage at full compression.  
Longer travel shock absorber. Use extended sway bar links OASU3322007 on vehicles with rear sway bars.

**RECOMMENDED OPTIONS & UPGRADES**

<p><b>Jounce Stop Kit - Rear</b></p> <p>OASU4270004 <b>\$185 kit</b></p>	<p>Parts included:</p> <p>2x (160mm jounce stops)</p> <p>Rubber, extended progressive rate (160mm, bonded brackets).</p> <p>Highly recommended for all vehicles with heavy rear loads.</p>
--	--

Lift heights are approximate and may vary depending on vehicle & product tolerances and load distribution.



# TOYOTA LANDCRUISER 79 SERIES SINGLE CAB (V8 2017+)



2017 + (models with new chassis design & DPF)

PRODUCT	PART NO.	DETAILS
Leaf Springs	OASU1178012	Trail - 40mm lift comfort (approx unladen) <i>8 primary + 2 secondary</i>
	OASU1178001	Trail - 50mm lift (approx unladen) <i>8 primary + 2 secondary</i>
	OASU1178002	Expedition - 50mm lift (@ approx 400kg load) <i>8 primary + 2 secondary</i>
	OASU1178010	Expedition HD - 50mm lift (@ approx 600kg load) <i>8 primary + 2 secondary</i>

Toyota Landcruiser 79 Series Leaf Spring Deflection

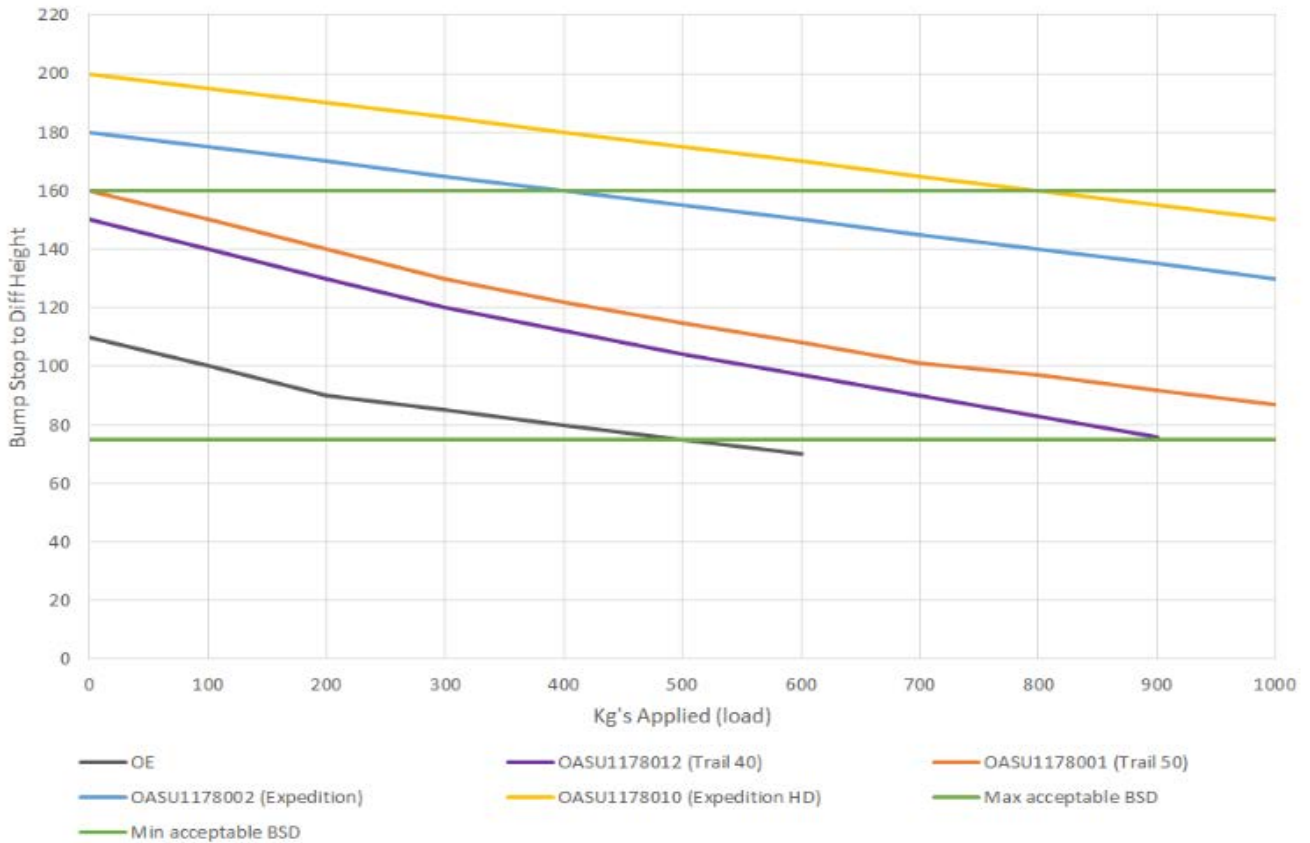

\* CWG (Centre Wheel to Guard) measured from centre of wheel to under-side of guard.

\* Max/Min Acceptable CWG are shown as a recommended guideline only.

\* CWG Heights approximate only, based on a standard dual cab style-side ute with no additional load.

Notes:

# TOYOTA LANDCRUISER 80-105 SERIES LIVE AXLE

9/1991 - 2006



PRODUCT	PART NO.	QTY	DETAILS
<b>Shock Absorbers</b> (front)	OASU0160016 \$175 ea.	2	<b>Performance</b> - 60mm twin tube. 2" lift Complete set of rubber bushes & washers included. Steel shroud.
	OASU0165016-ADJ \$220 ea.	2	<b>Adjustable Internal Bypass</b> - 65mm twin tube. 2" lift Complete set of rubber bushes & dust boot included.
<b>Shock Absorbers</b> (rear)	OASU0160017 \$175 ea.	2	<b>Performance</b> - 60mm twin tube. 2" lift Complete set of rubber bushes & washers included. Steel shroud.
	OASU0165017-ADJ \$220 ea.	2	<b>Adjustable Internal Bypass</b> - 65mm twin tube. 2" lift Complete set of rubber bushes & dust boot included.
<b>Steering Damper</b>	OASU0954002 \$150 ea.	1	51mm twin tube foam cell construction. Complete set of bushes & tapered pins included. Steel shroud.
<b>Coil Springs</b> (front, pair)	OASU1010001 \$260 pr.	1	Trail - 50mm lift (approx unladen)
	OASU1010003 \$260 pr.	1	Expedition - 50mm lift (@ approx 100kg load)
<b>Coil Springs</b> (rear, pair)	OASU1010002 \$260 pr.	1	Trail - 50mm lift (approx unladen)
	OASU1010004 \$275 pr.	1	Expedition - 50mm lift (@ approx 100kg load)
	OASU1010006 \$390 pr.	1	Expedition HD - 50mm lift (@ approx 300kg load)

## ACCESSORY ITEMS & CORRECTION COMPONENTS

<b>Caster Correction Bush Kits</b>	OASU210100K \$200 kit	1	Rubber - 2 degree caster increase (set of 4).
<b>Coil Spring Spacers</b>	OASU2110209 \$40 ea.	2	Front - 10mm, polyurethane
	OASU2120210 \$55 ea.	2	Front - 20mm, polyurethane
	OASU2130211 \$75 ea.	2	Front - 30mm, polyurethane
	OASU2110212 \$40 ea.	2	Rear - 10mm, polyurethane
	OASU2115213 \$50 ea.	2	Rear - 15mm, polyurethane
	OASU2120214 \$75 ea.	2	Rear - 20mm, polyurethane
	OASU2130215 \$85 ea.	2	Rear - 30mm, polyurethane

\* Ride heights approximates only, with no additional load, unless otherwise stated.

\* Outback Armour recommend that a minimum of two thirds of the original suspension travel in each direction is retained for optimal performance and durability.

# TOYOTA LANDCRUISER 80-105 SERIES LIVE AXLE

9/1991 - 2006



## SUSPENSION KITS - FRONT

PERFORMANCE v	ADJ. INTERNAL BYPASS v	
------------------	---------------------------	--

**Trail** Lift front: 50mm (approx unladen)  
Suits vehicles with oem bumper or light front loads

OASU918000T <b>\$760 kit</b>	OASU918000T-ADJ <b>\$850 kit</b>	
2x OASU0160016 (shocks)	2x OASU0165016-ADJ (shocks)	
* kit prices include shock absorbers listed above plus the following parts *		
1 pair OASU1010001 (coil springs)	1x OASU0954002 (steering damper)	

**Expedition** Lift front: 50mm (@approx 100kg load)  
Suits vehicles with a steel bullbar, winch or medium front loads

OASU918000E <b>\$760 kit</b>	OASU918000E-ADJ <b>\$850 kit</b>	
2x OASU0160016 (shocks)	2x OASU0165016-ADJ (shocks)	
* kit prices include shock absorbers listed above plus the following parts *		
1 pair OASU1010003 (coil springs)	1x OASU0954002 (steering damper)	

### RECOMMENDED OPTIONS & UPGRADES

<b>Caster Correction Front</b> OASU210100K <b>\$200 kit</b>	Parts included: 1x OASU210100K (2 degree caster correction kit) Includes: 4x rubber bushes with fitting instructions.
---	---

Lift heights are approximate and may vary depending on vehicle or product tolerances and load distribution.

**TOYOTA LANDCRUISER 80-105 SERIES LIVE AXLE**

9/1991 - 2006



**SUSPENSION KITS - REAR**

PERFORMANCE v	ADJ. INTERNAL BYPASS v	
------------------	---------------------------	--

**Trail** Lift rear: 50mm (approx unladen)  
Suits vehicles with light or occasional medium loads

OASU928000T <b>\$610 kit</b>	OASU928000T-ADJ <b>\$700 kit</b>	
2x OASU0160017 (shocks)	2x OASU0165017-ADJ (shocks)	

\* kit prices include shock absorbers listed above plus the following parts \*  
1 pair OASU1010002 (coil springs)

**Expedition** Lift rear: 50mm (@ approx 100kg load)  
Suits vehicles with constant medium or occasional heavy loads

OASU928000E <b>\$625 kit</b>	OASU928000E-ADJ <b>\$715 kit</b>	
2x OASU0160017 (shocks)	2x OASU0165017-ADJ (shocks)	

\* kit prices include shock absorbers listed above plus the following parts \*  
1 pair OASU1010004 (coil springs)

**Expedition HD** Lift rear: 50mm (@ approx 300kg load)  
Suits vehicles with constant heavy loads

OASU928000H <b>\$740 Kit</b>	OASU928000H-ADJ <b>\$830 Kit</b>	
2x OASU0160017 (shocks)	2x OASU0165017-ADJ (shocks)	

\* kit prices include shock absorbers listed above plus the following parts \*  
1 pair OASU1010006 (coil springs)

Lift heights are approximate and may vary depending on vehicle & product tolerances and load distribution.



# TOYOTA LANDCRUISER 100 SERIES IFS

4/1998 - 10/2007



PRODUCT	PART NO.	QTY	DETAILS
<b>Shock Absorbers</b> (front) Max CWG: 530	OASU0160005 \$175 ea.	2	<b>Performance</b> - 60mm twin tube. Complete set of rubber bushes, washers & dust boot included.
	OASU0160038 \$175 ea.	2	<b>Performance</b> - 60mm twin tube. Complete set of rubber bushes & washers included. Steel shroud.
<b>Shock Absorbers</b> (rear)	OAAV0160027 (coil-over) \$265 ea.	2	<b>Performance</b> - 60mm twin tube. Complete set of rubber bushes & washers, coil spring, fitting kit and lower spherical bearing included. * Suits vehicles with permanent heavy rear loads.
	OASU1211153 \$425 pr.	1	Trail / Expedition - Suits diesel, turbo diesel & 6cyl petrol. Increased rate, 1210mm length, 32mm diameter.
<b>Torsion Bars</b> (pair)	OASU1211154 \$425 pr.	1	Trail / Expedition - Suits V8 petrol. Increased rate, 1160mm length, 32mm diameter.
	** Torsion bars include lower control arm reinforcing brackets.		
<b>Coil Springs</b> (pair)	OASU1010002 \$260 pr.	1	Trail - 50mm lift (approx unladen)
	OASU1010004 \$275 pr.	1	Expedition - 50mm lift (@ approx 100kg load)
	OASU1010006 \$390 pr.	1	Expedition HD - 50mm lift (@ approx 300kg load)

## ACCESSORY ITEMS & CORRECTION COMPONENTS

<b>Bump Stops</b>	OASU4210102 \$27.50 ea.	2	Front - Rubber, extended progressive rate (60mm)
<b>Diff Drop Kit</b>	OASU3211002 \$395 kit	1	25mm, includes cross-member, bolts & spacers

\* Ride heights approximates only, with no additional load, unless otherwise stated.

\* Outback Armour recommend that a minimum of two thirds of the original suspension travel in each direction is retained for optimal performance and durability.

## RECOMMENDED RECOVERY GEAR

<b>Snatch Strap</b>	OASS8T9M	1	Dynamic Snatch Strap - 8T/9M (2.66T - 4.00T)
<b>Recovery Kits</b>	OAQUICKSKLT	1	Quick Snatch Kit - Light Truck
	OACOMPSKLT	1	Comp Snatch Kit - Light Truck
	OAWINCHKIT	1	Winch Utility Kit

\*\* Complete range of Outback Armour recovery gear available at rear of this guide.

Notes:

# TOYOTA LANDCRUISER 100 SERIES IFS

4/1998 - 10/2007



## SUSPENSION KITS - FRONT

PERFORMANCE v	ADJ. INTERNAL BYPASS v	
------------------	---------------------------	--

**Trail** Lift front: Torsion bar (height adjustable)  
Suits vehicles with oem bumper or light front loads

OASU911000T <b>\$350 kit</b>	Not available for this vehicle	
2x OASU0160005 (shocks)		
Note: Torsion bars not supplied with this kit.		

**Expedition Kit A** Lift front: Torsion bar (height adjustable)  
Suits vehicles with a steel bullbar, winch or medium front loads

OASU911000EA <b>\$775 kit</b>	Not available for this vehicle	
2x OASU0160005 (shocks)		

\* kit prices include shock absorbers listed above plus the following parts \*

1 pair OASU1211153 (torsion bars)

Note: Torsion bars suit TLC100 turbo diesel models.

**Expedition Kit B** Lift front: Torsion bar (height adjustable)  
Suits vehicles with a steel bullbar, winch or medium front loads

OASU91100EB <b>\$775 kit</b>	Not available for this vehicle	
2x OASU0160005 (shocks)		

\* kit prices include struts listed above plus the following parts \*

1 pair OASU1211154 (torsion bars)

Note: Torsion bars suit TLC100 V8 petrol models.

## RECOMMENDED OPTIONS & UPGRADES

<b>Jounce Stop Kit - Front</b>	Parts included:
OASU4210202 <b>\$55 kit</b>	2x OASU4210102 (jounce stops) Rubber, extended progressive rate (60mm / M10x25mm). Highly recommended to be installed in all vehicles with bullbars.

Lift heights are approximate and may vary depending on vehicle or product tolerances and load distribution.

**TOYOTA LANDCRUISER 100 SERIES IFS**

4/1998 - 10/2007



**SUSPENSION KITS - REAR**

PERFORMANCE v	ADJ. INTERNAL BYPASS v	
------------------	---------------------------	--

**Trail**

Lift rear: 50mm (approx unladen)  
Suits vehicles with light or occasional medium loads

OASU921000T <b>\$610 kit</b>	Not available for this vehicle	
2x OASU0160038 (shocks)		

\* kit prices include shock absorbers listed above plus the following parts \*  
1 pair OASU1010002 (coil springs)

**Expedition**

Lift rear: 50mm (@ approx 100kg load)  
Suits vehicles with constant medium or occasional heavy loads

OASU921000E <b>\$625 kit</b>	Not available for this vehicle	
2x OASU0160038 (shocks)		

\* kit prices include shock absorbers listed above plus the following parts \*  
1 pair OASU1010004 (coil springs)

**Expedition HD**

Lift rear: 50mm (@ approx 300kg load)  
Suits vehicles with constant heavy loads

OASU921000H <b>\$740 kit</b>	Not available for this vehicle	
2x OASU0160038 (shocks)		

\* kit prices include shock absorbers listed above plus the following parts \*  
1 pair OASU1010006 (coil springs)

Lift heights are approximate and may vary depending on vehicle & product tolerances and load distribution.





# TOYOTA LANDCRUISER 200 SERIES

11/2007 +



PRODUCT	PART NO.	QTY	DETAILS
<b>Struts</b> Max CWG: 565	OASU0860002 \$220 ea.	2	<b>Performance</b> - 60mm twin tube. Spacer ring adjustable height spring seat. Complete set of rubber bushes, washers & dust boot included.
	OASU0865002-ADJ \$320 ea.	2	<b>Adjustable Internal Bypass</b> - 65mm twin tube. Threaded variable height spring seat. Complete set of rubber bushes, washers & dust boot included.
<b>Shock Absorbers</b>	OASU0160038 \$175 ea.	2	<b>Performance</b> - 60mm twin tube. Complete set of rubber bushes & washers included. Steel shroud.
	OASU0165038-ADJ \$220 ea.	2	<b>Adjustable Internal Bypass</b> - 65mm twin tube. Complete set of rubber bushes & dust boot included.
	OAAV0160027 (coil-over) \$265 ea.	2	<b>Performance</b> - 60mm twin tube. Complete set of rubber bushes, washers, coil spring and lower spherical bearing included. * Suits vehicles with permanent heavy rear loads. * <b>Does not fit on vehicles with KDSS.</b>
<b>Coil Springs</b> (front, pair)	OASU1020001 \$260 pr.	1	Trail/Exped - 40mm lift (approx unladen, adj. struts to 50mm) <i>For vehicles with added accessories, use the supplied spacer rings on struts to retain vehicle ride height.</i>
	OASU1020007 \$260 pr.	1	Exped HD- 40mm lift (approx unladen, adj. struts to 50mm) <i>Heavier spring rate. For vehicles with added accessories, use the supplied spacer rings on struts to retain vehicle ride height.</i>
<b>Coil Springs</b> (rear, pair)	OASU1020002 \$275 pr.	1	Trail - 15mm lift (approx unladen)
	OASU1020004 \$290 pr.	1	Expedition - 30mm lift (approx unladen)
	OASU1020006 \$350 pr.	1	Expedition HD - 30mm lift (@ approx 150kg load)
	OASU1020008 \$350 pr.	1	Expedition HD - 30mm lift (@ approx 350kg load)

## ACCESSORY ITEMS & CORRECTION COMPONENTS

<b>Bump Stops</b>	OASU4210102 \$27.50 ea.	2	Front - Rubber, extended progressive rate (60mm)
	OASU4220004 \$185 kit	1	Rear - Rubber, extended progressive rate (2x 160mm)
<b>Diff Drop Kit</b>	OASU3211003 \$185 kit	1	25mm, includes bolts & spacers.
<b>Strut Mount</b>	OASU0720003 \$80 ea.	2	Supplied with all required nuts, washers and bushes.

\* Ride heights approximates only, with no additional load, unless otherwise stated.

\* Outback Armour recommend that a minimum of two thirds of the original suspension travel in each direction is retained for optimal performance and durability.

## RECOMMENDED RECOVERY GEAR

<b>Snatch Strap</b>	OASS8T9M	1	Dynamic Snatch Strap - 8T/9M (2.66T - 4.00T)
<b>Recovery Kits</b>	OAQUICKSKLT	1	Quick Snatch Kit - Light Truck
	OACOMPSKLT	1	Comp Snatch Kit - Light Truck
	OAWINCHKIT	1	Winch Utility Kit

\*\* Complete range of Outback Armour recovery gear available at rear of this guide.

# TOYOTA LANDCRUISER 200 SERIES

11/2007 +



## SUSPENSION KITS - FRONT

PERFORMANCE v	ADJ. INTERNAL BYPASS v	
------------------	---------------------------	--

### Trail & Expedition

Lift front: 40mm (approx) height adjustable struts to 50mm  
Suits vehicles with oem bumper, bullbar or light front loads

OASU912000T \$700 kit	OASU912000T-ADJ \$900 kit	
2x OASU0860002 (struts)	2x OASU0865002-ADJ (struts)	

\* kit prices include struts listed above plus the following parts \*

1x OASU1020001 (coil springs)

Coil spring seat spacers included with struts for height adjustment.

### Expedition HD

Lift front: 40mm (approx) height adjustable struts to 50mm  
Suits vehicles with a steel bullbar, winch or heavy front loads

OASU912000H \$700 kit	OASU912000H-ADJ \$900 kit	
2x OASU0860002 (struts)	2x OASU0865002-ADJ (struts)	

\* kit prices include struts listed above plus the following parts \*

1x OASU1020007 (coil springs)

Spring rate increased for heavy front bullbar and winch combinations.

Coil spring seat spacers included with struts for height adjustment.

### ° Assembled Struts - Trail

Lift front: 50mm (@ approx 0-50kg load)  
Suits vehicles with oem bumper or light front loads

OASU932000T \$880 pr.	OASU932000T-ADJ \$1,080 pr.	
2x OASU392000T (each)	2x OASU392000T-ADJ (each)	

Assembled struts include: struts, coil springs & top mounts.

### ° Assembled Struts - Exped

Lift front: 50mm (@ approx 50-100kg load)  
Suits vehicles with a steel bullbar or medium front loads

OASU932000E \$880 pr.	OASU932000E-ADJ \$1,080 pr.	
2x OASU392000E (each)	2x OASU392000E-ADJ (each)	

Assembled struts include: struts, coil springs & top mounts.

### ° Assembled Struts - Exped HD

Lift front: 50mm (@ approx 100-150kg load)  
Suits vehicles with a steel bullbar & winch or heavy front loads

OASU932000H \$880 pr.	OASU932000H-ADJ \$1,080 pr.	
2x OASU392000H (each)	2x OASU392000H-ADJ (each)	

Assembled struts include: struts, coil springs & top mounts.

## RECOMMENDED OPTIONS & UPGRADES

<b>Jounce Stop Kit - Front</b>	Parts included:
OASU4210202 \$55 kit	2x OASU4210102 (jounce stops) Rubber, extended progressive rate (60mm / M10x25mm). Highly recommended to be installed in all vehicles with bullbars.

Lift heights are approximate and may vary depending on vehicle or product tolerances and load distribution.

# TOYOTA LANDCRUISER 200 SERIES

11/2007 +



## SUSPENSION KITS - REAR

PERFORMANCE v	ADJ. INTERNAL BYPASS v	
------------------	---------------------------	--

### Trail Lift rear: 15mm (approx unladen) Suits vehicles with light or occasional medium loads

OASU922000T <b>\$625 kit</b>	OASU922000T-ADJ <b>\$715 kit</b>	
2x OASU0160038 (shocks)	2x OASU0165038-ADJ (shocks)	

\* kit prices include shock absorbers listed above plus the following parts \*

1 pair OASU1020002 (coil springs)

Rear bump stop kit "OASU4220004" highly recommended to reduce risk of component damage at full compression.

### Expedition Lift rear: 30mm (approx unladen) Suits vehicles with constant medium or occasional heavy loads

OASU922000E <b>\$640 kit</b>	OASU922000E-ADJ <b>\$730 kit</b>	
2x OASU0160038 (shocks)	2x OASU0165038-ADJ (shocks)	

\* kit prices include shock absorbers listed above plus the following parts \*

1 pair OASU1020004 (coil springs)

Rear bump stop kit "OASU4220004" highly recommended to reduce risk of component damage at full compression.

### Expedition HD Lift rear: 30mm (@ approx 150kg load) Suits vehicles with constant heavy loads

OASU922000H <b>\$700 kit</b>	OASU922000H-ADJ <b>\$790 kit</b>	
2x OASU0160038 (shocks)	2x OASU0165038-ADJ (shocks)	

\* kit prices include shock absorbers listed above plus the following parts \*

1 pair OASU1020006 (coil springs)

Rear bump stop kit "OASU4220004" highly recommended to reduce risk of component damage at full compression.

### Expedition XHD Lift rear: 30mm (@ approx 350kg load) Suits vehicles with constant heavy loads

OASU922000X <b>\$700 kit</b>	OASU922000X-ADJ <b>\$790 kit</b>	
2x OASU0160038 (shocks)	2x OASU0165038-ADJ (shocks)	

\* kit prices include shock absorbers listed above plus the following parts \*

1 pair OASU1020008 (coil springs)

Rear bump stop kit "OASU4220004" highly recommended to reduce risk of component damage at full compression.

## RECOMMENDED OPTIONS & UPGRADES

<b>Jounce Stop Kit - Rear</b>  OASU4220004 <b>\$185 kit</b>	Parts included: 2x 160mm jounce stops Rubber, extended progressive rate (160mm, bonded brackets). Highly recommended for all vehicles with heavy rear loads.
--	---

Lift heights are approximate and may vary depending on vehicle & product tolerances and load distribution.



# TOYOTA PRADO 120 SERIES

120 Series: (12/2002 - 8/2009)



PRODUCT	PART NO.	QTY	DETAILS
<b>Struts</b> Max CWG: 560	OASU0860003 \$220 ea.	2	<b>Performance</b> - 60mm twin tube. Spacer ring adjustable height spring seat. Complete set of rubber bushes, washers & dust boot included.
	OASU0865003-ADJ \$320 ea.	2	<b>Adjustable Internal Bypass</b> - 65mm twin tube. Threaded variable height spring seat. Complete set of rubber bushes, washers & dust boot included.
<b>Shock Absorbers</b>	OASU0160028 \$175 ea.	2	<b>Performance</b> - 60mm twin tube. Complete set of rubber bushes included. Steel shroud.
	OASU0165028-ADJ \$220 ea.	2	<b>Adjustable Internal Bypass</b> - 65mm twin tube. Complete set of rubber bushes & dust boot included.
<b>Coil Springs</b> (front, pair)	OASU1015001 \$260 pr.	1	Trail - 35mm lift (approx unladen, adj. struts to 50mm) <i>For vehicles with added accessories, use the supplied spacer rings on struts to retain vehicle ride height.</i>
	OASU1015003 \$260 pr.	1	Expedition - 50mm lift (approx unladen, adj. struts to 50mm) <i>Heavier rate coil for vehicles with added accessories including bullbars, winches &amp; dual battery systems.</i>
	OASU1015005 \$260 pr.	1	Exped HD - 40mm lift (approx unladen, adj. struts to 50mm) <i>Heavier rate coil for heavy bullbar &amp; winch applications. Springs seat spacers supplied with struts to adjust ride height.</i>
	OASU1015007 \$260 pr.	1	Trail KDSS - 35mm lift (approx unladen, adj. struts to 50mm) <i>These coils must be used on all vehicles fitted with KDSS. Springs seat spacers supplied with struts to adjust ride height.</i>
<b>Coil Springs</b> (rear, pair)	OASU1015002 \$260 pr.	1	Trail - 35mm lift (approx unladen)
	OASU1015004 \$260 pr.	1	Expedition - 35mm lift (@ approx 150kg load)
	OASU1015006 \$330 pr.	1	Expedition HD - 35mm lift (@ approx 350kg load)

## ACCESSORY ITEMS & CORRECTION COMPONENTS

<b>Bump Stops</b>	OASU4210102 \$27.50 ea	2	Front - Rubber, extended progressive rate (60mm/M10x25mm)
<b>Strut Mount</b>	OASU0712001 \$80 ea.	2	Suits FJ Cruiser 12 Series. Supplied with all required nuts, washers and bushes.

\* Ride heights approximates only, with no additional load, unless otherwise stated.

\* Outback Armour recommend that a minimum of two thirds of the original suspension travel in each direction is retained for optimal performance and durability.

## RECOMMENDED RECOVERY GEAR

<b>Snatch Strap</b>	OASS6T9M	1	Dynamic Snatch Strap - 6T/9M (2.00T - 3.00T)
<b>Recovery Kits</b>	OAQUICKSKST	1	Quick Snatch Kit - Small Truck
	OACOMPSKST	1	Comp Snatch Kit - Small Truck
	OAWINCHKIT	1	Winch Utility Kit

\*\* Complete range of Outback Armour recovery gear available at rear of this guide.

Notes:

# TOYOTA PRADO 120 SERIES

120 Series: (12/2002 - 8/2009)



## SUSPENSION KITS - FRONT

PERFORMANCE

v

ADJ. INTERNAL BYPASS

v

### Trail

Lift front: 35mm (approx) height adjustable struts to 50mm

OASU911501T

\$700 kit

OASU911501T-ADJ

\$900 kit

2x OASU0860003 (struts)

2x OASU0865003-ADJ (struts)

\* kit prices include struts listed above plus the following parts \*

1x OASU1015001 (coil springs)

Coil spring seat spacers included with struts for height adjustment.

Suits vehicles with oem bumper or light front loads.

### Expedition

Lift front: 50mm (approx) height adjustable struts to 50mm

OASU911501E

\$700 kit

OASU911501E-ADJ

\$900 kit

2x OASU0860003 (struts)

2x OASU0865003-ADJ (struts)

\* kit prices include struts listed above plus the following parts \*

1x OASU1015003 (coil springs)

Coil spring seat spacers included with struts for height adjustment.

Suits vehicles with a steel bullbar or medium front loads.

### Expedition HD

Lift front: 50mm (@ approx 100kg load)

OASU911501H

\$700 kit

OASU911501H-ADJ

\$900 kit

2x OASU0860003 (struts)

2x OASU0865003-ADJ (struts)

\* kit prices include struts listed above plus the following parts \*

1x OASU1015005 (coil springs)

Coil spring seat spacers included with struts for height adjustment.

Suits vehicles with a steel bullbar, winch or heavy front loads.

Lift heights are approximate and may vary depending on vehicle or product tolerances and load distribution.

# TOYOTA PRADO 120 SERIES

120 Series: (12/2002 - 8/2009)



## SUSPENSION KITS - FRONT

**PERFORMANCE**  
v

**ADJ. INTERNAL BYPASS**  
v

### ° Assembled Struts - Trail

Lift front: 50mm (@ approx 0-50kg load)  
Suits vehicles with oem bumper or light front loads

OASU931201T \$880 pr.	OASU931201T-ADJ \$1,080 pr.	
2x OASU391201T (each)	2x OASU391201T-ADJ (each)	

Assembled struts include: struts, coil springs & top mounts.

### ° Assembled Struts - Exped

Lift front: 50mm (@ approx 50-100kg load)  
Suits vehicles with a steel bullbar or medium front loads

OASU931201E \$880 pr.	OASU931201E-ADJ \$1,080 pr.	
2x OASU391201E (each)	2x OASU391201E-ADJ (each)	

Assembled struts include: struts, coil springs & top mounts.

### ° Assembled Struts - Exped HD

Lift front: 50mm (@ approx 100-150kg load)  
Suits vehicles with a steel bullbar & winch or heavy front loads

OASU931201H \$880 pr.	OASU931201H-ADJ \$1,080 pr.	
2x OASU391201H (each)	2x OASU391201H-ADJ (each)	

Assembled struts include: struts, coil springs & top mounts.

## RECOMMENDED OPTIONS & UPGRADES

### Jounce Stop Kit - Front

OASU4210202  
\$55 kit

Parts included:

2x OASU4210102 (jounce stops)  
Rubber, extended progressive rate (60mm / M10x25mm).  
Highly recommended to be installed in all vehicles with bullbars.

Lift heights are approximate and may vary depending on vehicle or product tolerances and load distribution.



# TOYOTA PRADO 120 SERIES

120 Series: (12/2002 - 8/2009)



## SUSPENSION KITS - REAR

**PERFORMANCE**

v

**ADJ. INTERNAL BYPASS**

v

Lift rear: 35mm (approx unladen)

Suits vehicles with light or occasional medium loads

### Trail

OASU921501T \$610 kit	OASU921501T-ADJ \$700 kit	
2x OASU0160028 (shocks)	2x OASU0165028-ADJ (shocks)	

\* kit prices include shock absorbers listed above plus the following parts \*

1 pair OASU1015002 (coil springs)

Lift rear: 35mm (@ approx 150kg load)

Suits vehicles with constant medium or occasional heavy loads

### Expedition

OASU921501E \$610 kit	OASU921501E-ADJ \$700 kit	
2x OASU0160028 (shocks)	2x OASU0165028-ADJ (shocks)	

\* kit prices include shock absorbers listed above plus the following parts \*

1 pair OASU1015004 (coil springs)

Lift rear: 35mm (@ approx 350kg load)

Suits vehicles with constant heavy loads

### Expedition HD

OASU921501H \$680 kit	OASU921501H-ADJ \$770 kit	
2x OASU0160028 (shocks)	2x OASU0165028-ADJ (shocks)	

\* kit prices include shock absorbers listed above plus the following parts \*

1 pair OASU1015006 (coil springs)

Lift heights are approximate and may vary depending on vehicle & product tolerances and load distribution.

# TOYOTA PRADO 150 SERIES

150 Series: (8/2009 +)



PRODUCT	PART NO.	QTY	DETAILS
<b>Struts</b> Max CWG: 560	OASU0860003 \$220 ea.	2	<b>Performance</b> - 60mm twin tube. Spacer ring adjustable height spring seat. Complete set of rubber bushes, washers & dust boot included.
	OASU0865003-ADJ \$320 ea.	2	<b>Adjustable Internal Bypass</b> - 65mm twin tube. Threaded variable height spring seat. Complete set of rubber bushes, washers & dust boot included.
<b>Shock Absorbers</b>	OASU0160028 \$175 ea.	2	<b>Performance</b> - 60mm twin tube. Complete set of rubber bushes included. Steel shroud.
	OASU0165028-ADJ \$220 ea.	2	<b>Adjustable Internal Bypass</b> - 65mm twin tube. Complete set of rubber bushes & dust boot included.
<b>Coil Springs</b> (front, pair)	OASU1015001 \$260 pr.	1	Trail - 35mm lift (approx unladen, adj. struts to 50mm) <i>For vehicles with added accessories, use the supplied spacer rings on struts to retain vehicle ride height.</i>
	OASU1015003 \$260 pr.	1	Expedition - 50mm lift (approx unladen, adj. struts to 50mm) <i>Heavier rate coil for vehicles with added accessories including bullbars, winches &amp; dual battery systems.</i>
	OASU1015005 \$260 pr.	1	Exped HD - 40mm lift (approx unladen, adj. struts to 50mm) <i>Heavier rate coil for heavy bullbar &amp; winch applications. Springs seat spacers supplied with struts to adjust ride height.</i>
	OASU1015007 \$260 pr.	1	Trail KDSS - 35mm lift (approx unladen, adj. struts to 50mm) <i>These coils must be used on all vehicles fitted with KDSS. Springs seat spacers supplied with struts to adjust ride height.</i>
<b>Coil Springs</b> (rear, pair)	OASU1015002 \$260 pr.	1	Trail - 35mm lift (approx unladen)
	OASU1015004 \$260 pr.	1	Expedition - 35mm lift (@ approx 150kg load)
	OASU1015006 \$330 pr.	1	Expedition HD - 35mm lift (@ approx 350kg load)

## ACCESSORY ITEMS & CORRECTION COMPONENTS

<b>Bump Stops</b>	OASU4210102 \$27.50 ea	2	Front - Rubber, extended progressive rate (60mm/M10x25mm)
<b>Stut Mount</b>	OASU0715002 \$80 ea.	2	Supplied with all required nuts, washers and bushes.

\* Ride heights approximates only, with no additional load, unless otherwise stated.

\* Outback Armour recommend that a minimum of two thirds of the original suspension travel in each direction is retained for optimal performance and durability.

## RECOMMENDED RECOVERY GEAR

<b>Snatch Strap</b>	OASS6T9M	1	Dynamic Snatch Strap - 6T/9M (2.00T - 3.00T)
<b>Recovery Kits</b>	OAQUICKSKST	1	Quick Snatch Kit - Small Truck
	OACOMPSKST	1	Comp Snatch Kit - Small Truck
	OAWINCHKIT	1	Winch Utility Kit

\*\* Complete range of Outback Armour recovery gear available at rear of this guide.

Notes:

# TOYOTA PRADO 150 SERIES

150 Series: (8/2009 +)



## SUSPENSION KITS - FRONT

**PERFORMANCE**

v

**ADJ. INTERNAL BYPASS**

v

### Trail

Lift front: 35mm (approx) height adjustable struts to 50mm

Suits vehicles with oem bumper or light front loads

OASU911501T \$700 kit	OASU911501T-ADJ \$900 kit	
2x OASU0860003 (struts)	2x OASU0865003-ADJ (struts)	

\* kit prices include struts listed above plus the following parts \*

1x OASU1015001 (coil springs)

Coil spring seat spacers included with struts for height adjustment.

### Expedition

Lift front: 50mm (approx unladen) height adjustable struts to 50mm

Suits vehicles with a steel bullbar or medium front loads

OASU911501E \$700 kit	OASU911501E-ADJ \$900 kit	
2x OASU0860003 (struts)	2x OASU0865003-ADJ (struts)	

\* kit prices include struts listed above plus the following parts \*

1x OASU1015003 (coil springs)

Coil spring seat spacers included with struts for height adjustment.

### Expedition HD

Lift front: 40mm (@ approx 100kg load) height adjustable struts to 50mm

Suits vehicles with a steel bullbar, winch or heavy front loads

OASU911501H \$700 kit	OASU911501H-ADJ \$900 kit	
2x OASU0860003 (struts)	2x OASU0865003-ADJ (struts)	

\* kit prices include struts listed above plus the following parts \*

1x OASU1015005 (coil springs)

Coil spring seat spacers included with struts for height adjustment.

Lift heights are approximate and may vary depending on vehicle or product tolerances and load distribution.

# TOYOTA PRADO 150 SERIES

150 Series: (8/2009 +)



## SUSPENSION KITS - FRONT

PERFORMANCE v	ADJ. INTERNAL BYPASS v	
------------------	---------------------------	--

### ° Assembled Struts - Trail

Lift front: 50mm (@ approx 0-50kg load)  
Suits vehicles with oem bumper or light front loads

OASU931501T \$880 pr.	OASU931501T-ADJ \$1,080 pr.	
2x OASU391501T (each)	2x OASU391501T-ADJ (each)	

Assembled struts include: struts, coil springs & top mounts.

### ° Assembled Struts - Exped

Lift front: 50mm (@ approx 50-100kg load)  
Suits vehicles with a steel bullbar or medium front loads

OASU931501E \$880 pr.	OASU931501E-ADJ \$1,080 pr.	
2x OASU391501E (each)	2x OASU391501E-ADJ (each)	

Assembled struts include: struts, coil springs & top mounts.

### ° Assembled Struts - Exped HD

Lift front: 50mm (@ approx 100-150kg load)  
Suits vehicles with a steel bullbar & winch or heavy front loads

OASU931501H \$880 pr.	OASU931501H-ADJ \$1,080 pr.	
2x OASU391501H (each)	2x OASU391501H-ADJ (each)	

Assembled struts include: struts, coil springs & top mounts.

## RECOMMENDED OPTIONS & UPGRADES

<b>Jounce Stop Kit - Front</b>  OASU4210202 \$55 kit	Parts included: 2x OASU4210102 (jounce stops) Rubber, extended progressive rate (60mm / M10x25mm). Highly recommended to be installed in all vehicles with bullbars.
---	---

Lift heights are approximate and may vary depending on vehicle or product tolerances and load distribution.

# TOYOTA PRADO 150 SERIES

150 Series: (8/2009 +)



## SUSPENSION KITS - REAR

**PERFORMANCE**

v

**ADJ. INTERNAL BYPASS**

v

Lift rear: 35mm (approx unladen)

Suits vehicles with light or occasional medium loads

### Trail

OASU921501T \$610 kit	OASU921501T-ADJ \$700 kit	
2x OASU0160028 (shocks)	2x OASU0165028-ADJ (shocks)	

\* kit prices include shock absorbers listed above plus the following parts \*

1 pair OASU1015002 (coil springs)

Lift rear: 35mm (@ approx 150kg load)

Suits vehicles with constant medium or occasional heavy loads

### Expedition

OASU921501E \$610 kit	OASU921501E-ADJ \$700 kit	
2x OASU0160028 (shocks)	2x OASU0165028-ADJ (shocks)	

\* kit prices include shock absorbers listed above plus the following parts \*

1 pair OASU1015004 (coil springs)

Lift rear: 35mm (@ approx 350kg load)

Suits vehicles with constant heavy loads

### Expedition HD

OASU921501H \$680 kit	OASU921501H-ADJ \$770 kit	
2x OASU0160028 (shocks)	2x OASU0165028-ADJ (shocks)	

\* kit prices include shock absorbers listed above plus the following parts \*

1 pair OASU1015006 (coil springs)

Lift heights are approximate and may vary depending on vehicle & product tolerances and load distribution.

# VOLKSWAGEN AMAROK

4/2010 +



PRODUCT	PART NO.	QTY	DETAILS
<b>Struts</b> Max CWG: 560	OASU0864004 \$235 ea.	2	<b>Performance</b> - 60mm twin tube. Spacer ring adjustable height spring seat. Additional piston rod jounce stop included.
	OASU0850007-ADJ \$250 ea.	2	<b>Adjustable Internal Bypass</b> - 50mm twin tube. Threaded variable height spring seat. Dust boot included.
<b>Shock Absorbers</b>	OASU0154008 \$175 ea.	2	<b>Performance</b> - 54mm twin tube. Complete set of rubber bushes & dust boot included.
	OASU0150008-ADJ \$200 ea.	2	<b>Adjustable Internal Bypass</b> - 50mm twin tube. Dust boot included.
<b>Coil Springs</b> (pair)	OASU1027001 \$260 pr.	1	Trail - 25mm lift (approx unladen, adj. struts to 45mm) <i>For vehicles with added accessories, use the supplied spacer rings on struts to retain vehicle ride height.</i>
	OASU1027003 \$260 pr.	1	Expedition - 35mm lift (approx unladen, adj. struts to 45mm) <i>For vehicles with added accessories, use the supplied spacer rings on struts to retain vehicle ride height. Suits bullbars, winches.</i>
<b>Leaf Springs</b>	OASU1127001 \$375 ea.	2	Trail - 35mm lift (approx unladen) <i>4 primary + 2 secondary</i>
	OASU1127002 \$385 ea.	2	Expedition - 35mm lift (@ approx 150kg load) <i>4 primary + 2 secondary</i>
	OASU1127003 \$415 ea.	2	Expedition - 35mm lift (@ approx 400kg load) <i>5 primary + 2 secondary</i>
	OASU1127004 \$430 ea.	2	Expedition - 35mm lift (@ approx 650kg load) <i>5 primary + 2 secondary</i>
<i>** Refer leaf spring graph following for approximate deflections under load.</i>			
<b>Leaf Spring Bush Kit</b>	OASU210026K \$300 kit	1	12 polyurethane bushes & 6 inner tubes
<b>U-bolts</b>	OASU2384001 \$15 ea.	4	Suits leaf springs: OASU1127001, OASU1127002, OASU1127003 & OASU1127004 <i>M14 x 84 ID (RND) x 215 L</i>
<i>** All u-bolts hardened steel, rolled threads, deep nuts &amp; spring washers.</i>			

\* Ride heights approximate only, based on standard dual cab style-side ute with no additional load, unless otherwise stated.

\* Outback Armour recommend that a minimum of two thirds of the original suspension travel in each direction is retained for optimal performance and durability.

## RECOMMENDED RECOVERY GEAR

<b>Snatch Strap</b>	OASS6T9M	1	Dynamic Snatch Strap - 6T/9M (2.00T - 3.00T)
<b>Recovery Kits</b>	OAQUICKSKST	1	Quick Snatch Kit - Small Truck
	OACOMPSKST	1	Comp Snatch Kit - Small Truck
	OAWINCHKIT	1	Winch Utility Kit

*\*\* Complete range of Outback Armour recovery gear available at rear of this guide.*

Notes:

**VOLKSWAGEN AMAROK**

4/2010 +

**SUSPENSION KITS - FRONT****PERFORMANCE**

v

**ADJ. INTERNAL BYPASS**

v

**Trail**

Lift front: 35mm (approx) height adjustable struts to 45mm

Suits vehicles with oem bumper or light front loads

OASU912700T \$730 kit	OASU912700T-ADJ \$760 kit	
2x OASU0864004 (struts)	2x OASU0850007-ADJ (struts)	

\* kit prices include struts listed above plus the following parts \*

1x OASU1027001 (coil springs)

Coil spring seat spacers included with struts for height adjustment.

**Expedition & Expedition HD**

Lift front: 35mm (approx) height adjustable struts to 45mm

Suits vehicles with steel bullbar or medium front loads

OASU912700E \$730 kit	OASU912700E-ADJ \$760 kit	
2x OASU0864004 (struts)	2x OASU0850007-ADJ (struts)	

\* kit prices include struts listed above plus the following parts \*

1x OASU1027003 (coil springs)

Coil spring seat spacers included with struts for height adjustment.

Lift heights are approximate and may vary depending on vehicle or product tolerances and load distribution.

# VOLKSWAGEN AMAROK

4/2010 +



## SUSPENSION KITS - REAR

PERFORMANCE v	ADJ. INTERNAL BYPASS v	
------------------	---------------------------	--

**Trail** Lift rear: 35mm (approx unladen)  
Suits vehicles with light or occasional medium loads

OASU922700T <b>\$1,460 kit</b>	OASU922700T-ADJ <b>\$1,510 kit</b>	
2x OASU0154008 (shocks)	2x OASU0150008-ADJ (shocks)	

\* kit prices include shock absorbers listed above plus the following parts \*

1x OASU210026K (bush kit)	2x OASU1127001 (leaf springs)	4x OASU2384001 (u-bolts)
---------------------------	-------------------------------	--------------------------

**Expedition** Lift rear: 35mm (@ approx 150kg load)  
Suits vehicles with constant medium or occasional heavy loads

OASU922700E <b>\$1,480 kit</b>	OASU922700E-ADJ <b>\$1,530 kit</b>	
2x OASU0154008 (shocks)	2x OASU0150008-ADJ (shocks)	

\* kit prices include shock absorbers listed above plus the following parts \*

1x OASU210026K (bush kit)	2x OASU1127002 (leaf springs)	4x OASU2384001 (u-bolts)
---------------------------	-------------------------------	--------------------------

**Expedition HD** Lift rear: 35mm (@ approx 400kg load)  
Suits vehicles with constant heavy loads

OASU922700H <b>\$1,540 kit</b>	OASU922700H-ADJ <b>\$1,590 kit</b>	
2x OASU0154008 (shocks)	2x OASU0150008-ADJ (shocks)	

\* kit prices include shock absorbers listed above plus the following parts \*

1x OASU210026K (bush kit)	2x OASU1127003 (leaf springs)	4x OASU2384001 (u-bolts)
---------------------------	-------------------------------	--------------------------

**Expedition XHD** Lift rear: 35mm (@ approx 650kg load)  
Suits vehicles with constant heavy loads

OASU922700X <b>\$1,570 kit</b>	OASU922700X-ADJ <b>\$1,620 kit</b>	
2x OASU0154008 (shocks)	2x OASU0150008-ADJ (shocks)	

\* kit prices include shock absorbers listed above plus the following parts \*

1x OASU210026K (bush kit)	2x OASU1127004 (leaf springs)	4x OASU2384001 (u-bolts)
---------------------------	-------------------------------	--------------------------

Lift heights are approximate and may vary depending on vehicle & product tolerances and load distribution.



PRODUCT	PART NO.	DETAILS
Leaf Springs	OASU1127001	Trail - 35mm lift (unladen) 4 primary + 2 secondary
	OASU1127002	Expedition - 35mm lift (@ approx 150kg load) 4 primary + 2 secondary
	OASU1127003	Expedition - 35mm lift (@ approx 400kg load) 5 primary + 2 secondary
	OASU1127004	Expedition - 35mm lift (@ approx 650kg load) 5 primary + 2 secondary

**Volkswagen Amarok Leaf Spring Deflection**

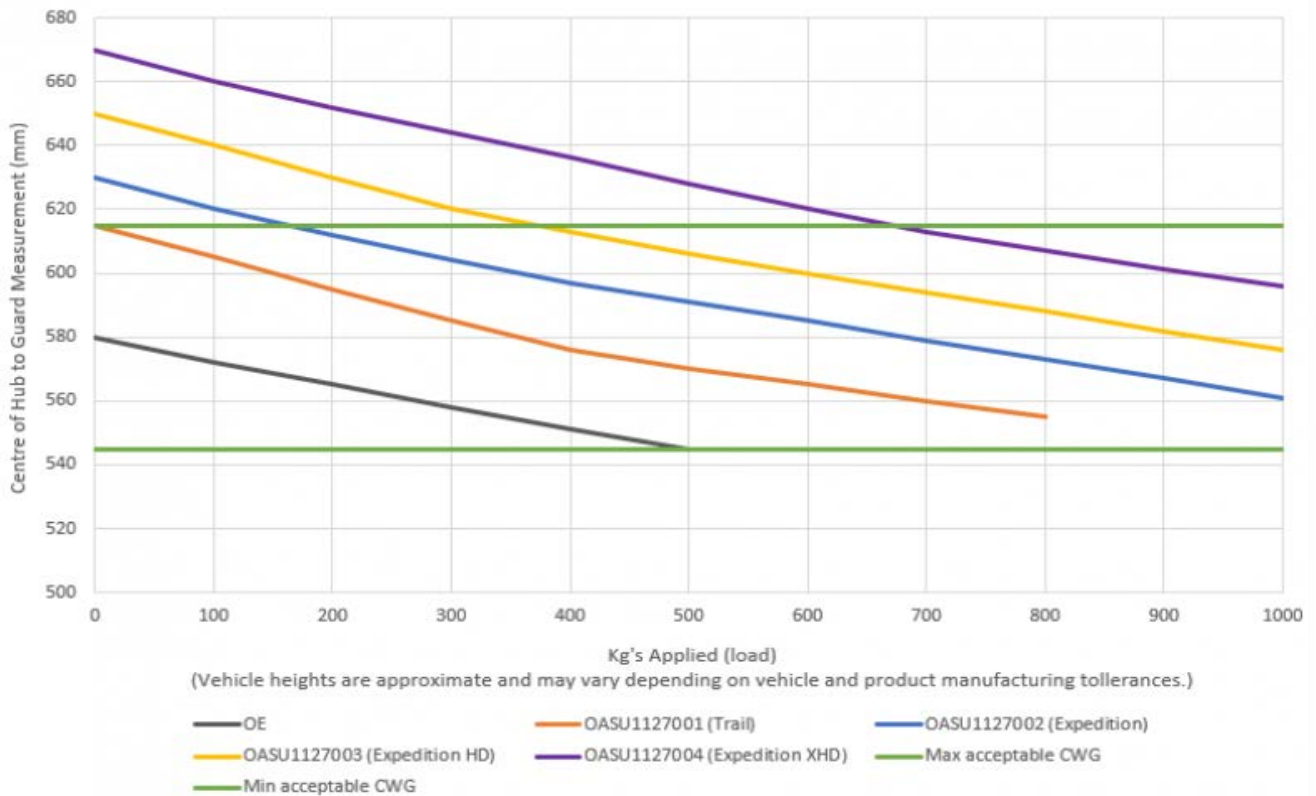

\* CWG (Centre Wheel to Guard) measured from centre of wheel to under-side of guard.

\* Max/Min Acceptable CWG are shown as a recommended guideline only.

\* CWG Heights approximate only, based on a standard dual cab style-side ute with no additional load.

Notes:

## SUSPENSION SPARE PARTS & ADDITIONAL LINES

### Toyota Hilux IFS (Pre 2005)

PRODUCT	PART NO.	QTY	DETAILS
Shock Absorbers (front)	OASU0160011 \$175 ea.	2	Performance - 60mm twin tube. Complete set of rubber bushes, washers & dust boot included.
Shock Absorbers (rear)	OASU0160013 \$175 ea.	2	Performance - 60mm twin tube. Complete set of rubber bushes & brake line spacer kit included.

### Toyota Landcruiser 75 Series

PRODUCT	PART NO.	QTY	DETAILS
Shock Absorbers (front)	OASU0160065 \$175 ea.	2	Performance - 60mm twin tube. Complete set of rubber bushes, washers & dust boot included.
Shock Absorbers (rear)	OASU0160032 \$175 ea.	2	Performance - 60mm twin tube. Complete set of rubber bushes & brake line spacer kit included.

Notes:

# VEHICLE FITMENT RECORD



## VEHICLE DETAILS

Make		VIN	
Model		Rego	
Year		KMS	
Variant	<input type="checkbox"/> Wagon <input type="checkbox"/> Custom <input type="checkbox"/> Dual Cab <input type="checkbox"/> Extra Cab <input type="checkbox"/> Single Cab	Engine	
		Trans.	

## CUSTOMER DETAILS

Name	
Phone	
Email	
Invoice #	

## INSTALLATION DETAILS

Retailer	
Sales Rep	
Installer	<input type="checkbox"/> Retailer <input type="checkbox"/> Other <input type="checkbox"/> Self
Date	

## PARTS FITMENT DETAIL

Part #: Shocks (front)		Part #: Shocks (rear)	
Part #: Springs (front)		Part #: Springs (rear)	

## VEHICLE ACCESSORIES & LOAD

FRONT:	<input type="checkbox"/> No Bar <input type="checkbox"/> Alloy Bar <input type="checkbox"/> Steel Bar <input type="checkbox"/> Nudge Bar <input type="checkbox"/> 3/4 Bars <input type="checkbox"/> Alloy Steps <input type="checkbox"/> Steel Steps <input type="checkbox"/> No Winch <input type="checkbox"/> Winch - Steel Cable <input type="checkbox"/> Winch - Synthetic Rope <input type="checkbox"/> Under Body Guards <input type="checkbox"/> Dual Battery System	REAR:	<input type="checkbox"/> OEM Tub <input type="checkbox"/> Alloy Tray <input type="checkbox"/> Steel Tray <input type="checkbox"/> Empty <input type="checkbox"/> Canopy <input type="checkbox"/> Camper <input type="checkbox"/> Drawers <input type="checkbox"/> Water <input type="checkbox"/> Fridge <input type="checkbox"/> L/R Fuel <input type="checkbox"/> Rear Bar <input type="checkbox"/> Tow Bar <input type="checkbox"/> Tool Boxes <input type="checkbox"/> Air Comp. <input type="checkbox"/> Tools <input type="checkbox"/> Roof Rack <input type="checkbox"/> Dual Battery System <input type="checkbox"/> Roof Tent <input type="checkbox"/> Wheel Carrier/s
--------	---	-------	--

Estimated Additional Front Load (KG): \_\_\_\_\_

Estimated Additional Rear Load (KG): \_\_\_\_\_

*(excluding 250kg original tub weight)*

Notes:

## CENTRE WHEEL TO GUARD MEASUREMENTS

### CWG - BEFORE

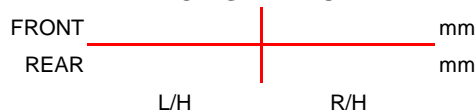

Measurements recorded by:

### FULL DROOP - BEFORE

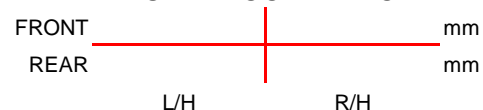

Date:

### CWG - AFTER

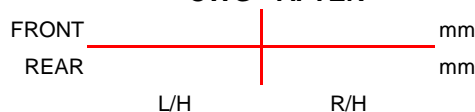

Measurements recorded by:

### FULL DROOP - AFTER

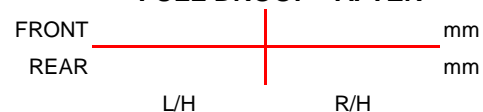

Date:

### CWG - 1000 KM

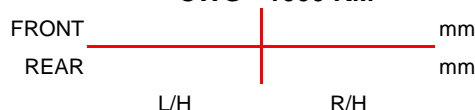

Measurements recorded by:

### FULL DROOP - 1000 KM

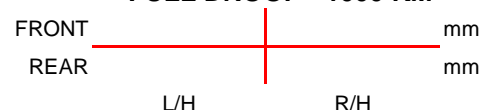

Date:

# STRUT ALIGNMENT INSTRUCTIONS



Toyota Hilux/Prado/FJ/Fortuner	Toyota Landcruiser 200 Series
--------------------------------	-------------------------------

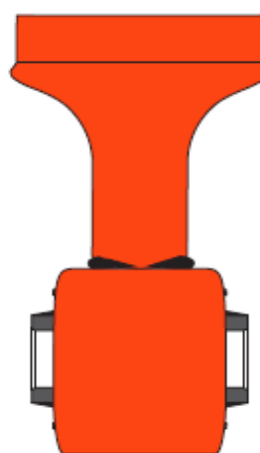
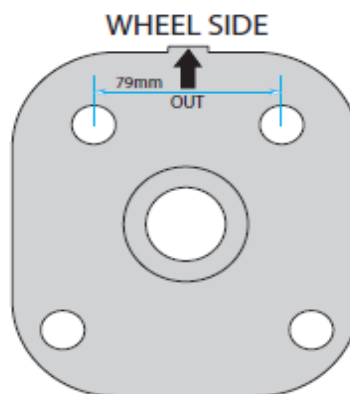
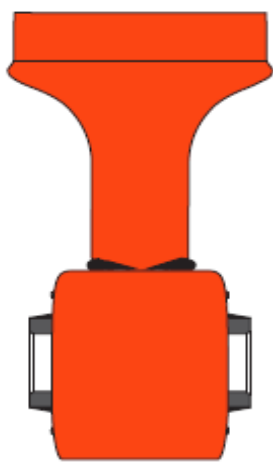
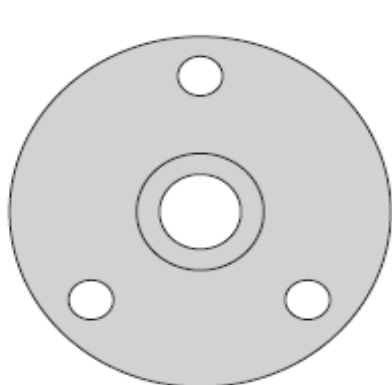

Nissan Navara NP300/D40	Mazda BT50 & Ford Ranger PX
-------------------------	-----------------------------

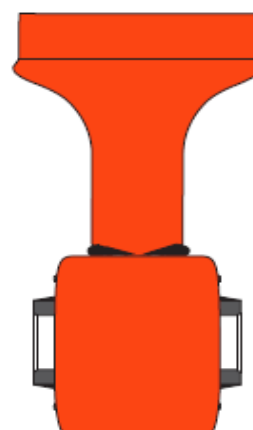
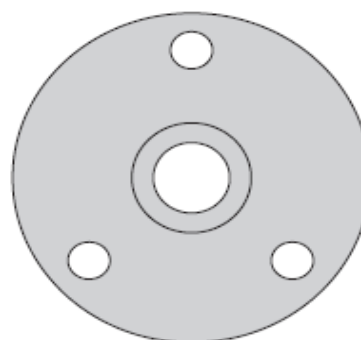
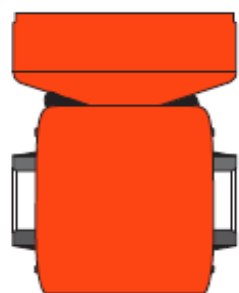
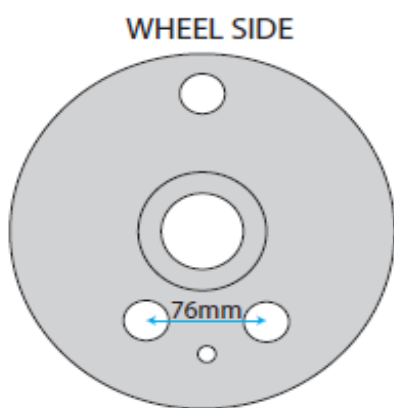

# STRUT ALIGNMENT INSTRUCTIONS



Mitsubishi Triton ML/MN  
Mitsubishi PB Challenger

Mitsubishi Triton MQ  
Mitsubishi Pajero Sport

WHEEL SIDE

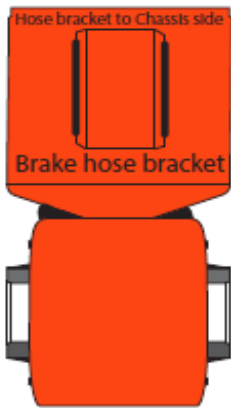
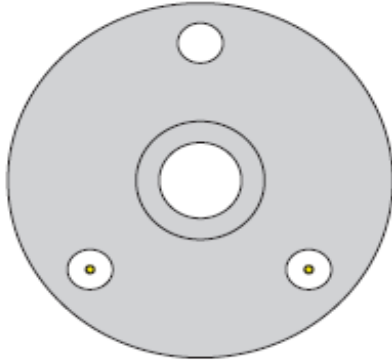

WHEEL SIDE

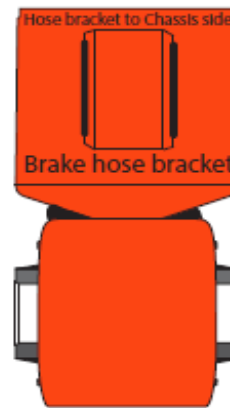
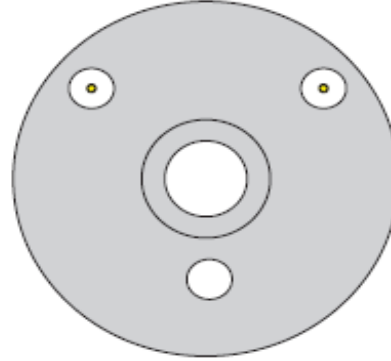

Isuzu D-Max & Holden Colorado RG

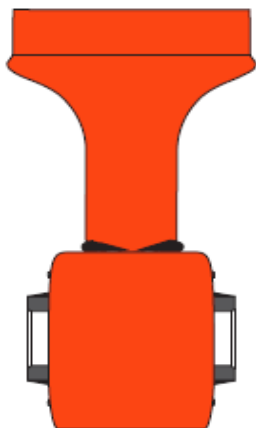
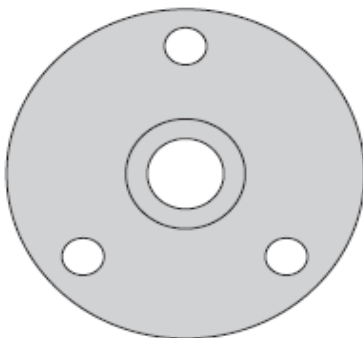

# TERMS & CONDITIONS OF SALE



as at January 2014.

## GENERAL

- 1 Outback Armour provides general application and correct usage guidelines for its products to assist with product selection. Any customer making the decision to modify or equip their vehicle with aftermarket products of any kind assumes all risk and responsibility for the suitability of those chosen modifications or accessories used.
- 2 Goods are sold with the express and/or implied customer acceptance of these terms and conditions of sale and the Outback Armour privacy and warranty policies, available on the [outbackarmour.com.au](http://outbackarmour.com.au) website.
- 3 Where products are delivered to a customer:
  - a. on Outback Armour's freight account, our responsibility and risk ceases upon delivery to and acceptance of the shipment by the customer from the transportation company.
  - b. on the customer's freight account, our responsibility and risk ceases on pick-up by the customer's transportation company.
- 4 All products should be inspected for loss or damage upon receipt and claim submitted immediately, but no later than 7 days following receipt of goods, to Outback Armour or the customer's transportation or insurance company as the case requires.
- 5 Outback Armour shall not be liable for any consequential loss or damage.

## RETENTION OF TITLE

- 1 The goods shall remain the property of Outback Armour until they are paid for in full and if the customer has possession of the goods, but they are still owned by Outback Armour, the customer shall be the trustee of those goods until they are paid for in full.
- 2 If the goods have not been paid for within the agreed terms of trade or the customer has become insolvent, the customer authorises Outback Armour to recover and account for such goods for which Outback Armour has not been paid, or to recover other Outback Armour goods in the customer's possession to the same value.

## GOODS RETURN

- 1 Outback Armour will accept goods returned for credit within 14 days from purchase provided:
  - a. an Outback Armour "return authorization number" has been requested in advance and accompanies the shipment together with a copy of the original invoice for returned goods if approval is granted.
  - b. any and all freight charges must be to the customer's account or pre-paid by the customer.
- 2 The goods must be in complete, unaltered and merchantable condition excluding normal wear and tear to packaging.
- 3 Customer acceptance of the goods means the acceptance of these terms and conditions.

Note: These terms and conditions are subject to change at any time without notification.

# WARRANTY POLICY

as at January 2014.



## WARRANTY TERMS & CONDITIONS

Outback Armour warrants its products to be free from faults or defects in workmanship and materials for the warranty term, from the date of retail sale, where used for the specified intended purpose and application, to the original purchaser only, with proof of purchase.

Outback Armour's obligation under this warranty is limited to the repair or replacement of the defective product at Outback Armour's option and to the extent permitted by law does not extend to cover claims for any other loss, damage or injury whether as a consequence of or arising from any defect or breakage of the product, or otherwise.

OUTBACK ARMOUR PRODUCTS	WARRANTY TERM
Shock absorbers, struts & steering dampers	3 years, unlimited kilometres (excludes strut mount bushes: 1 year)
Coil, leaf & torsion bar springs	3 years, unlimited kilometres
U-bolts, shackles & pins	3 years, unlimited kilometres
Other suspension components	3 years, unlimited kilometres

This warranty specifically excludes liability for:

- a. normal wear and tear and product finish.
- b. any labour, shipping/freight, removal, installation or other incidental costs.
- c. products used in: off-road motor sport, military, armoured vehicles or applications for which the product was not originally designed.
- d. damage occurring on vehicles loaded in excess of manufacturers GVM specifications.
- e. damage caused by alteration, incorrect installation or fitment, lack of or improper maintenance, abuse or neglect.

## ENQUIRIES & CLAIMS

Warranty claims should be made directly with the authorised dealer where the products were purchased from or directly with Outback Armour under approved circumstances. Product may be required to be returned to Outback Armour for warranty inspection.

All warranty claim submissions must be submitted with proof of purchase for the products and a completed Warranty Claim Submission form. Download Warranty Form from the [outbackarmour.com.au](http://outbackarmour.com.au) website.

For additional information about this warranty, please contact us:

OUTBACK ARMOUR PTY LTD  
163 Granite Street, Geebung 4034 Queensland Australia  
PO Box 500, Hamilton Central 4007 Queensland Australia  
phone: +61 7 3265 4142  
email: [warranty@outbackarmour.com.au](mailto:warranty@outbackarmour.com.au)

## AUSTRALIAN COMPETITION & CONSUMER ACT 2012

Our goods come with guarantees that cannot be excluded under the Australian Consumer Law. You are entitled to a replacement or refund for a major failure and compensation for any other reasonably foreseeable loss or damage. You are also entitled to have the goods repaired or replaced if the goods fail to be of acceptable quality and the failure does not amount to a major failure.

# RECOVERY GEAR LIST



PART NO.	PRODUCT	DETAILS
OASS6T9M	Snatch Strap - 6T/9M	6 tonne x 9 metre rated snatch strap suits vehicles weighing 2.00T - 3.00T
OASS8T9M	Snatch Strap - 8T/9M	8 tonne x 9 metre rated snatch strap suits vehicles weighing 2.66T - 4.00T
OASS11T9M	Snatch Strap - 11T/9M	11 tonne x 9 metre rated snatch strap suits vehicles weighing 3.66T - 5.50T
OASS15T9M	Snatch Strap - 15T/9M	15 tonne x 9 metre rated snatch strap suits vehicles weighing 5.00T-7.50T
OATS4T6M	Tow Strap - 4T/6M	4 tonne x 6 metre rated recoil tow strap
Oawe10T20M	Winch Extension Strap - 10T/20M	10 tonne x 20 metre rated winch extension strap
OAEQ10T3M	Equaliser Strap - 10T/3M	10 tonne x 3 metre rated equaliser strap
OATP10T5M	Tree Trunk Protector Strap - 10T/5M	10 tonne x 5 metre rated tree trunk protector strap
OARH575T	Recovery Hitch (65mm pin position) (5.75T Bow Shackle + 10T Hitch)	10 tonne x 50mm rated recovery hitch includes 5.75T rated bow shackle pin position 65mm from end of hitch receiver
OARH220	Recovery Hitch (120mm pin position) (5.75T Bow Shackle + 10T Hitch)	10 tonne x 50mm rated recovery hitch includes 5.75T rated bow shackle pin position 120mm from end of hitch receiver
OABS475T	Bow Shackle - 4.75T WLL Rated	4.75 tonne rated recovery bow shackle
OABS575T	Bow Shackle - 5.75T WLL Rated	5.75 tonne rated recovery bow shackle
OASB10T	Snatch Block - 10T WLL Rated	10 tonne rated recovery snatch block
OARB1KG	Recovery Blanket	competition specification recovery blanket
OAGLOVELG	Recovery Gloves - (Medium/Large)	leather lined safety recovery gloves
OAGLOVEXL	Recovery Gloves - (Extra Large)	synthetic lined safety recovery gloves
OABAGQUICK	Recovery Bag (600mmx160mmx160mm)	water & tear resistant heavy duty PVC
OABAGCOMP	Recovery Bag (700mmx180mmx180mm)	water & tear resistant heavy duty PVC
OAQUICKSKST	Quick Snatch Kit - Small Truck	includes 6T/9M snatch strap
OAQUICKSKLT	Quick Snatch Kit - Light Truck	includes 8T/9M snatch strap
OACOMPSKST	Comp Snatch Kit - Small Truck	includes 6T/9M snatch strap
OACOMPSKLT	Comp Snatch Kit - Light Truck	includes 8T/9M snatch strap
OACOMPSKHT	Comp Snatch Kit - Heavy Truck	includes 11T/9M snatch strap
OACOMPSKXT	Comp Snatch Kit - Extra Heavy Truck	includes 15T/9M snatch strap
OAWINCHKIT	Winch Utility Kit	10 tonne straps plus hardware
OAWINCHKITXT	Winch Utility Kit - Extra Heavy Truck	10 tonne straps plus hardware



# RECOVERY ACCESSORIES



<b>OABS475T</b> \$12.50 ea	<b>OABS575T</b> \$15 ea
<b>4.75T Rated Bow Shackle</b> 5x WLL tested 19mm bow diameter 21mm pin diameter * Bows and pins are each batch numbered to ensure rating is maintained once component parts are separated.	<b>5.75T Rated Bow Shackle</b> 5x WLL tested 21mm bow diameter 24mm pin diameter



<b>OARH575T</b> \$82.50 ea	<b>OARH220</b> \$92.50 ea
<b>Recovery Hitch - Short</b> 10T rated for recovery 1.5x WLL tested Suits 50mm x 50mm receiver Clockable pin position Pin depth 60mm Includes 5.75T bow shackle Fits 4.75T bow shackle	<b>Recovery Hitch - Long</b> 10T rated for recovery 1.5x WLL tested Suits 50mm x 50mm receiver Clockable pin position Pin depth 60mm & 120mm Includes 5.75T bow shackle Fits 4.75T bow shackle



<b>OASB10T</b> \$69 ea
<b>10T Rated Snatch Block</b> 1.5x WLL tested CNC machined pulley wheel Nut fastened for strength Internal brass bush Greaseable 9.5mm steel cable max diameter



<b>OABAGQUICK</b> \$59 ea.	<b>OABAGCOMP</b> \$69 ea.
<b>Recovery Bag - Medium</b> Heavy duty reinforced PVC Water / tear resistant 60cm x 15cm x 15cm YKK heavy duty zipper	<b>Recovery Bag - Large</b> Heavy duty reinforced PVC Water / tear resistant 70cm x 20cm x 20cm YKK heavy duty zipper



<b>OARB1KG</b> \$44.50 ea.
<b>Competition Recovery Blanket</b> Heavy duty reinforced PVC Water / tear resistant 2x internal pockets Min weight >1kg Min width >500mm Min Height >450mm folded * Includes hook strap attached for ease of attachment and safe handling.



# RECOVERY STRAPS



## DYNAMIC SNATCH STRAPS

<b>OASS6T9M</b> \$59 ea <b>6T/9M Snatch Strap</b> Material: High tenacity nylon Working Load Limit: 6 tonnes Colour: Outback orange Suits: 2.0T - 3.0T vehicle	<b>OASS8T9M</b> \$69 ea <b>8T/9M Snatch Strap</b> Material: High tenacity nylon Working Load Limit: 8 tonnes Colour: Outback orange Suits: 2.6T - 4.0T vehicle
<b>OASS11T9M</b> \$99 ea <b>11T/9M Snatch Strap</b> Material: High tenacity nylon Working Load Limit: 11 tonnes Colour: Outback orange Suits: 3.6T - 5.5T vehicle	<b>OASS15T9M</b> \$139 ea <b>15T/9M Snatch Strap</b> Material: High tenacity nylon Working Load Limit: 15 tonnes Colour: Outback orange Suits: 5.0T - 7.5T vehicle



## STATIC UTILITY STRAPS

<b>OATS4T6M</b> \$39 ea <b>4T/6M Recoil Tow Strap</b> Material: Polyester Working Load Limit: 4 tonnes Colour: Outback orange Length: 6m (recoils to 3m)
<b>OAEQ10T3M</b> \$39 ea <b>10T/3M Equaliser Strap</b> Working Load Limit: 10 tonnes Material: Polyester Colour: Campfire black
<b>OATP10T5M</b> \$49 ea <b>10T/5M Tree Trunk Protector Strap</b> Working Load Limit: 10 tonnes Material: Polyester Colour: Bush green
<b>OAW10T20M</b> \$149 ea <b>10T/20M Winch Extension Strap</b> Working Load Limit: 10 tonnes Material: Polyester Colour: Oxide red
<b>OAHOOKSTRAP</b> \$5 ea <b>Hook Strap</b> Material: Polyester Colour: Orange / Black Length: 23cm
<b>OAJSTRAP</b> \$5 ea <b>Joiner Strap</b> Material: High tenacity nylon Colour: Outback orange Length: 20cm



## QUICK SNATCH RECOVERY KITS



<b>OAQUICKSKST</b>	\$139 ea	<b>OAQUICKSKLT</b>	\$159 ea
Quick Snatch - Small Truck		Quick Snatch - Light Truck	
6T/9M snatch strap		8T/9M snatch strap	
2x 4.75T rated bow shackles		2x 4.75T rated bow shackles	
Heavy duty recovery bag		Heavy duty recovery bag	
Suits: 2.0T - 3.0T vehicle		Suits: 2.6T - 4.0T vehicle	



## COMP SNATCH RECOVERY KITS



<b>OACOMPSKST</b> \$254 ea <b>Comp Snatch - Small Truck</b> 6T/9M snatch strap 10T/3M equaliser strap 2x 4.75T rated bow shackles 1x 5.75T rated bow shackle Competition recovery blanket Recovery gloves (M/L) Hook strap Joiner strap Heavy duty recovery bag Suits: 2.0T - 3.0T vehicle	<b>OACOMPSKLT</b> \$274 ea <b>Comp Snatch - Light Truck</b> 8T/9M snatch strap 10T/3M equaliser strap 2x 4.75T rated bow shackles 1x 5.75T rated bow shackle Competition recovery blanket Recovery gloves (M/L) Hook strap Joiner strap Heavy duty recovery bag Suits: 2.6T - 4.0T vehicle
<b>OACOMPSKHT</b> \$294 ea <b>Comp Snatch - Heavy Truck</b> 11T/9M snatch strap 10T/3M equaliser strap 2x 4.75T rated bow shackles 1x 5.75T rated bow shackle Competition recovery blanket Recovery gloves (M/L) Hook strap Joiner strap Heavy duty recovery bag Suits: 3.6T - 5.5T vehicle	<b>OACOMPSKXT</b> \$339 ea <b>Comp Snatch - Extra Heavy Truck</b> 15T/9M snatch strap 10T/3M equaliser strap 3x 5.75T rated bow shackle Recovery gloves (M/L) Competition recovery blanket Hook strap Joiner strap Heavy duty recovery bag Suits: 5.0T - 7.5T vehicle





## WINCH UTILITY KITS



<b>OAWINCHKIT</b>	<b>\$389 ea</b>	<b>OAWINCHKITXT</b>	<b>\$399 ea</b>
<b>Winch Utility Kit</b>		<b>Winch Utility Kit - Extra Heavy Truck</b>	
10T/20M winch extension strap		10T/20M winch extension strap	
10T/5M tree protector strap		10T/5M tree protector strap	
10T rated snatch block		10T rated snatch block	
2x 4.75T rated bow shackles		3x 5.75T rated bow shackle	
1x 5.75T rated bow shackle		Competition recovery blanket	
Competition recovery blanket		Recovery gloves (M/L)	
Recovery gloves (M/L)		Hook strap	
Hook strap		Heavy duty recovery bag	
Heavy duty recovery bag			









**AUSTRALIA**

163 Granite Street Geebung 4034, Queensland Australia

Phone: +61 7 3265 4142

[contact@outbackarmour.com.au](mailto:contact@outbackarmour.com.au)

[facebook.com/outbackarmour](https://facebook.com/outbackarmour)

[outbackarmour.com.au](http://outbackarmour.com.au)

---